



SERVICE STATION MANUAL

854190



SCARABEO 500



SERVICE STATION MANUAL

SCARABEO 500

The descriptions and illustrations given in this publication are not binding; While the basic characteristics as described and illustrated in this manual remain unchanged, **aprilia** reserves the right, at any time and without being required to update this publication beforehand, to make any changes to components, parts or accessories, which it considers necessary to improve the product or which are required for manufacturing or construction reasons.

Not all versions shown in this publication are available in all countries. The availability of individual models should be confirmed with the official **aprilia** sales network.

© Copyright 2006- **aprilia**. All rights reserved. Reproduction of this publication in whole or in part is prohibited. **aprilia** - After-sales service.

aprilia trademark is property of Piaggio & C. S.p.A.

SERVICE STATION MANUAL

SCARABEO 500

NOTE Provides key information to make the procedure easier to understand and carry out.

CAUTION Refers to specific procedures to carry out for preventing damages to the vehicle.

WARNING Refers to specific procedures to carry out to prevent injuries to the repairer.



Personal safety Failure to completely observe these instructions will result in serious risk of personal injury.



Safeguarding the environment Sections marked with this symbol indicate the correct use of the vehicle to prevent damaging the environment.



Vehicle intactness The incomplete or non-observance of these regulations leads to the risk of serious damage to the vehicle and sometimes even the invalidity of the guarantee.



INDEX OF TOPICS

CHARACTERISTICS

CHAR

TOOLING

TOOL

MAINTENANCE

MAIN

ELECTRICAL SYSTEM

ELE SYS

ENGINE FROM VEHICLE

ENG VE

ENGINE

ENG

INJECTION

INJEC

SUSPENSIONS

SUSP

BRAKING SYSTEM

BRAK SYS

COOLING SYSTEM

COOL SYS

CHASSIS

CHAS

PRE-DELIVERY

PRE DE

INDEX OF TOPICS

CHARACTERISTICS

CHAR

Rules

Safety rules

GENERAL PRECAUTIONS AND INFORMATION

When repairing, dismantling and reassembling the vehicle, follow the recommendations given below carefully.

CAUTION

USE OF NAKED FLAMES IS FORBIDDEN DURING ALL TYPES OF OPERATION. BEFORE STARTING ANY MAINTENANCE OPERATION OR INSPECTION ON THE VEHICLE, SWITCH OFF THE ENGINE AND REMOVE THE KEY. WAIT UNTIL THE ENGINE AND THE EXHAUST SYSTEM ARE COLD, IF POSSIBLE, RAISE THE VEHICLE USING A SUITABLE TOOL ON FIRM AND LEVEL GROUND. TO AVOID BURNS PAY SPECIAL CARE WITH HOT ENGINE AND EXHAUST SYSTEM PARTS.

DO NOT HOLD ANY MECHANICAL OR OTHER SCOOTER PARTS WITH YOUR MOUTH: SCOOTER COMPONENT ARE NOT EDIBLE, ON THE CONTRARY SOME OF THEM ARE HARMFUL AND EVEN TOXIC.

CARBON MONOXIDE

If you need to keep the engine running in order to carry out any procedure, please ensure that you do so in an open or very well ventilated area.

Never let the engine run in an enclosed area.

If you do work in an enclosed area, make sure to use a smoke-extraction system.

CAUTION



EXHAUST EMISSIONS CONTAIN CARBON MONOXIDE, A POISONOUS GAS WHICH CAN CAUSE LOSS OF CONSCIOUSNESS AND EVEN DEATH.

FUEL

CAUTION



FUEL USED TO DRIVE EXPLOSION ENGINES IS HIGHLY FLAMMABLE AND CAN BECOME EXPLOSIVE UNDER SPECIFIC CONDITIONS.

IT IS THEREFORE RECOMMENDED TO CARRY OUT REFUELLING AND MAINTENANCE PROCEDURES IN A VENTILATED AREA WITH THE ENGINE SWITCHED OFF.

DO NOT SMOKE DURING REFUELLING AND NEAR FUEL VAPOURS, AVOIDING ANY CONTACT WITH NAKED FLAMES, SPARKS OR OTHER SOURCES WHICH MAY CAUSE THEM TO IGNITE OR EXPLODE.

CAUTION



DO NOT DISPOSE OF FUEL INTO THE ENVIRONMENT.

CAUTION



KEEP OUT OF THE REACH OF CHILDREN

HIGH-TEMPERATURE COMPONENTS

The engine and the components of the exhaust system can get very hot and remain hot for some time even after the engine has been switched off.

Before handling these components, make sure that you are wearing insulating gloves or wait until the engine and the exhaust system have cooled down.

TRANSMISSION OIL AND USED FORK OIL

CAUTION



IT IS ADVISABLE TO WEAR LATEX GLOVES WHEN CARRYING OUT SERVICE WORK. THE TRANSMISSION OIL MAY CAUSE SKIN DAMAGE IF HANDLED FREQUENTLY AND FOR LONG PERIODS.

WASH YOUR HANDS CAREFULLY AFTER HANDLING OIL.

HAND THE OIL OVER TO OR HAVE IT COLLECTED BY THE NEAREST USED OIL RECYCLING COMPANY OR THE SUPPLIER.

IT IS ADVISABLE TO WEAR LATEX GLOVES WHEN CARRYING OUT SERVICE WORK.

CAUTION



DO NOT DISPOSE OF OIL INTO THE ENVIRONMENT.

CAUTION



KEEP OUT OF THE REACH OF CHILDREN

BRAKE FLUID

CAUTION



THE BRAKE FLUID MAY DAMAGE PAINTED, PVC OR RUBBER SURFACES. WHEN SERVICING THE BRAKE SYSTEM, PROTECT THESE COMPONENTS WITH A CLEAN CLOTH.

ALWAYS WEAR PROTECTIVE GOGGLES WHEN SERVICING THE BRAKE SYSTEM.

THE BRAKE FLUID IS EXTREMELY DANGEROUS TO THE EYES.

IN THE EVENT OF ACCIDENTAL CONTACT WITH THE EYES, RINSE THEM IMMEDIATELY WITH ABUNDANT COLD, CLEAN WATER AND SEEK MEDICAL ADVICE.

CAUTION



KEEP OUT OF THE REACH OF CHILDREN

HYDROGEN GAS AND BATTERY ELECTROLYTE

CAUTION



THE BATTERY ELECTROLYTE IS TOXIC, CORROSIVE AND AS IT CONTAINS SULPHURIC ACID, IT CAN CAUSE BURNS WHEN IN CONTACT WITH THE SKIN.

WHEN HANDLING THE BATTERY ELECTROLYTE, WEAR TIGHT-FITTING GLOVES AND PROTECTIVE APPAREL.

IF THE ELECTROLYTIC FLUID GETS INTO CONTACT WITH THE SKIN, WASH WITH ABUNDANT COOL WATER.

IT IS PARTICULARLY IMPORTANT TO PROTECT THE EYES BECAUSE EVEN TINY AMOUNTS OF BATTERY ACID MAY CAUSE BLINDNESS. IF IT COMES INTO CONTACT WITH THE EYES,

RINSE THEM CAREFULLY WITH WATER FOR FIFTEEN MINUTES, THEN SEE AN EYE SPECIALIST AS SOON AS POSSIBLE.

IF IT IS ACCIDENTALLY SWALLOWED, DRINK LARGE QUANTITIES OF WATER OR MILK, FOLLOWED BY MILK OF MAGNESIA OR VEGETAL OIL, AND SEEK MEDICAL ADVICE IMMEDIATELY.

THE BATTERY RELEASES EXPLOSIVE GASES. KEEP IT AWAY OF FLAMES, SPARKS, CIGARETTES OR ANY OTHER HEAT SOURCE.

ENSURE ADEQUATE VENTILATION WHEN SERVICING OR RECHARGING THE BATTERY.

CAUTION



KEEP OUT OF THE REACH OF CHILDREN

CAUTION



THE BATTERY LIQUID IS CORROSIVE.

DO NOT POUR OR SPILL IT, PARTICULARLY ON PLASTIC COMPONENTS.

ENSURE THAT THE ELECTROLYTIC ACID IS COMPATIBLE WITH THE BATTERY TO BE ACTIVATED.

Maintenance rules

GENERAL PRECAUTIONS AND INFORMATION

When repairing, dismantling and reassembling the vehicle, follow the recommendations given below carefully.

CAUTION

UNLESS OTHERWISE INDICATED, REFIT THE UNIT FOLLOWING THE REMOVAL STEPS BUT IN REVERSE ORDER. THE POSSIBLE OVERLAPPING OF OPERATIONS REFERRED TO IN THE OTHER CHAPTERS MUST BE CARRIED OUT LOGICALLY, AVOIDING ANY UNNECESSARY REMOVAL OF COMPONENTS. DO NOT POLISH MATT PAINTWORK WITH ABRASIVE PASTES. NEVER USE FUEL AS SOLVENT FOR CLEANING THE SCOOTER.

DO NOT USE ALCOHOL, PETROL OR SOLVENTS TO CLEAN RUBBER AND PLASTIC PARTS AND THE SADDLE. USE ONLY WATER AND NEUTRAL SOAP INSTEAD.

DISCONNECT THE NEGATIVE CABLE (-) OF THE BATTERY IF YOU INTEND TO CARRY OUT ELECTRICAL WELDING WORK.

BEFORE REMOVING COMPONENTS

- Before dismantling components, remove dirt, mud, dust and foreign bodies from the vehicle.
- Use the specific tools designed for this scooter, as required.

REMOVAL OF COMPONENTS

- Do not loosen and/or tighten screws and nuts using pliers or other tools than the specially designed wrench.
- Mark positions on all connection joints (pipes, cables etc.) before separating them, and identify them with distinctive symbols.
- Each component needs to be clearly marked in order to be identified during reassembly.
- Clean and wash the dismantled components carefully using a low-flammability detergent.

- Keep coupled parts together since they have "adjusted" to each other due to normal wear and tear.
- Some components must be used together or replaced altogether.
- Keep away from heat sources.

REASSEMBLING COMPONENTS

CAUTION



NEVER REUSE A CIRCLIP; IF A CIRCLIP HAS BEEN REMOVED, IT MUST BE REPLACED WITH A NEW ONE. WHEN INSTALLING A CIRCLIP, ENSURE THAT ITS ENDS ARE NOT STRETCHED MORE THAN IS NECESSARY TO FIT IT ONTO THE SHAFT.

AFTER INSTALLING THE CIRCLIP, CHECK THAT IT IS FULLY AND CLEANLY INSTALLED IN ITS SEAT.

DO NOT USED COMPRESSED AIR TO CLEAN BEARINGS.

NOTE

BEARINGS MUST BE ABLE TO ROTATE FREELY, WITHOUT JAMMING AND/OR NOISE, OTHERWISE THEY NEED REPLACING.

- Use only ORIGINAL aprilia SPARE PARTS.
- Comply with lubricant and consumables usage guidelines.
- Lubricate parts (whenever possible) before reassembling them.
- When tightening nuts and screws, start from the ones with the largest section or from the internal ones, moving diagonally. Tighten nuts and screws in successive steps before applying the tightening torque.
- Always replace self-locking nuts, washers, sealing rings, circlips, O-rings, split pins and screws with new ones if their thread is damaged.
- When fitting bearings, make sure to lubricate them well.
- Check that each component is fitted correctly.
- After a repair or routine maintenance procedure, carry out pre-ride checks and test the vehicle on private grounds or in an area with low traffic density.
- Clean all junction surfaces, oil guard rims and washers before refitting them. Smear a light layer of lithium-based grease on the oil guard rims. Reassemble the oil guards and the bearings with the brand or lot number facing outward (visible side).

ELECTRIC CONNECTORS

Electric connectors must be disconnected as described below as non-compliance with the procedure so described causes irreparable damage to both the connector and the cable harness: Press the relevant safety hooks, if any.

CAUTION



TO DISCONNECT THE TWO CONNECTORS, DO NOT PULL THE CABLES.

- Grip the two connectors and disconnect them by pulling them in opposite directions.

- In presence of dirt, rust, humidity etc., clean the connector's internal parts carefully, using a pressurised air jet.
- Make sure that the cables are correctly linked to the connector's internal terminal ends.

NOTE

THE TWO CONNECTORS CONNECT ONLY FROM ONE SIDE; CONNECT THEM THE RIGHT WAY ROUND.

- Then fit the two connectors making sure that they couple correctly (if the relevant hooks are provided, you will hear them "click" into place).

TIGHTENING TORQUE**CAUTION**

DO NOT FORGET THAT TIGHTENING TORQUES OF ALL FASTENING ELEMENTS ON WHEELS, BRAKES, WHEEL SPINDLES AND OTHER SUSPENSION COMPONENTS PLAY A KEY ROLE IN ENSURING THE VEHICLE'S SAFETY AND MUST COMPLY WITH SPECIFIED VALUES. CHECK THE TIGHTENING TORQUES OF FASTENING PARTS ON A REGULAR BASIS AND ALWAYS USE A TORQUE WRENCH TO REASSEMBLE THESE COMPONENTS. IF THESE RECOMMENDATIONS ARE NOT COMPLIED WITH, ONE OF THE COMPONENTS MAY BECOME LOOSE AND EVEN DETACHED, THUS BLOCKING A WHEEL, OR OTHERWISE COMPROMISING THE VEHICLE'S MANOEUVRABILITY. THIS CAN LEAD TO FALLS, WITH THE RISK OF SERIOUS INJURY OR DEATH.

BRAKE FLUID**CAUTION**

DO NOT USE FLUIDS OTHER THAN THOSE PRESCRIBED AND DO NOT MIX DIFFERENT LIQUIDS WHEN TOPPING UP IN ORDER NOT TO DAMAGE THE BRAKE SYSTEM. DO NOT USE BRAKE FLUID TAKEN FROM OLD CONTAINERS OR FROM CONTAINERS THAT HAVE BEEN OPEN FOR A PROLONGED TIME. SUDDEN CHANGES IN THE PLAY OR ELASTIC RESISTANCE IN THE BRAKE LEVERS ARE DUE TO FAULTS IN THE HYDRAULIC CIRCUIT. MAKE ESPECIALLY SURE THAT BRAKE DISCS AND THE FRICTION MATERIAL ARE NOT SMEARED OR GREASY, PARTICULARLY AFTER CARRYING OUT MAINTENANCE AND INSPECTION OPERATIONS. CHECK THAT BRAKE WIRES ARE NOT TWISTED OR WORN. ENSURE THAT WATER OR DUST DO NOT INGRESS INADVERTENTLY INTO THE CIRCUIT. IT IS ADVISABLE TO WEAR LATEX GLOVES WHEN SERVICING THE HYDRAULIC CIRCUIT.

DISC BRAKE**CAUTION**

ANY OIL OR OTHER LIQUIDS ON A DISC WILL SOIL THE BRAKE PADS. SOILED PADS MUST BE REMOVED AND REPLACED. A SOILED DISC OR A DISC WITH TRACES OF OIL MUST BE CLEANED WITH A TOP QUALITY DEGREASING AGENT. IF THE SCOOTER IS USED CLOSE TO WATER OR ON DUSTY OR UNSURFACED ROADS, OR IF IT IS USED FOR SPORTS APPLICATION, HALVE THE SERVICE INTERVALS.

COOLANT

The engine is cooled by forced fluid circulation system. The coolant liquid is made up of 50% de-ionised water and 50% glycol ethylene-based antifreeze solution with corrosion inhibitors. The product recommended in the "recommended products table" is already mixed and ready to use.

For the best functioning of the engine the temperature of the coolant fluid should register in the central zone of the appropriate gauge. If the needle enters the red zone, stop the engine, allow it to cool, and check the level of the fluid; if it is normal, contact an **Official aprilia Dealer**.

CAUTION

DO NOT USE YOUR VEHICLE IF THE COOLANT LEVEL IS BELOW THE MINIMUM LEVEL MARKED "MIN".

CAUTION

COOLANT IS TOXIC IF INGESTED; CONTACT WITH EYES OR SKIN MAY CAUSE IRRITATION. IN THE EVENT OF CONTACT WITH EYES OR SKIN, RINSE REPEATEDLY WITH ABUNDANT WATER AND SEEK MEDICAL ADVICE. IF ACCIDENTALLY INGESTED, INDUCE VOMITING, RINSE MOUTH AND THROAT WITH ABUNDANT WATER AND SEEK MEDICAL ADVICE IMMEDIATELY.

CAUTION

DO NOT REMOVE THE EXPANSION TANK PLUG WHEN THE ENGINE IS HOT AS COOLANT IS UNDER PRESSURE AND AT A HIGH TEMPERATURE. CONTACT WITH SKIN OR CLOTHES MAY CAUSE SEVERE BURNS AND/OR INJURIES.

TYRES**CAUTION**

CHANGING, REPAIR, MAINTENANCE AND BALANCING ARE IMPORTANT OPERATIONS THAT ARE CARRIED OUT BY QUALIFIED PERSONNEL USING SUITABLE TOOLS. THE NEW TYRES MAY BE COVERED WITH A THIN LAYER OF PROTECTIVE COATING THAT IS SLIPPERY. DRIVE CAREFULLY FOR THE FIRST FEW KILOMETRES (MILES). NEVER USE RUBBER TREATMENT AGENTS OF ANY KIND ON THE TYRES. IN PARTICULAR ENSURE THAT THE TYRES DO NOT COME INTO CONTACT WITH LIQUID FUEL THAT WOULD CAUSE A RAPID DETERIORATION OF THE RUBBER. A TYRE THAT HAS BEEN IN CONTACT WITH OIL OR PETROL MUST BE REPLACED AND NOT SIMPLY CLEANED. DO NOT FIT TYRES WITH INNER TUBES ON RIMS FOR TUBELESS TYRES AND VICE VERSA.

Vehicle identification

These numbers are necessary for vehicle registration.

NOTE

ALTERING IDENTIFICATION NUMBERS CAN BE SERIOUSLY PUNISHED BY LAW, PARTICULARLY MODIFYING THE CHASSIS NUMBER WILL IMMEDIATELY INVALIDATE THE WARRANTY.

Chassis number

The chassis number is stamped on the front frame; to read it, open the glove-box and remove the snap-on protection cover.



Engine number

The engine number is stamped on the rear side, next to the left shock absorber.



Dimensions and mass

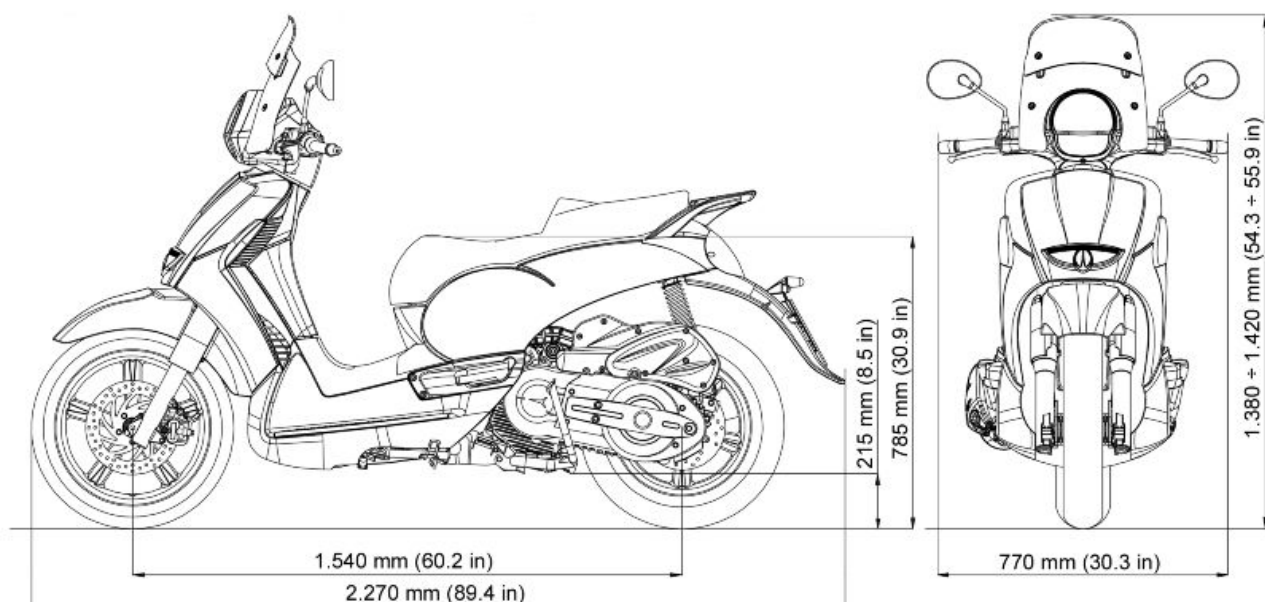

WEIGHT AND DIMENSIONS

Specification	Desc./Quantity
Max. length	2.270 mm (89.4 in)

Specification	Desc./Quantity
Max. width	770 mm (30.3 in)
Max. height (to top fairing)	1.380 ÷ 1.420 mm (54.3 ÷ 55.9 in)
Saddle height	785 mm (30.9 in)
Wheelbase	1.540 mm (60.2 in)
Minimum ground clearance	215 mm (8.5 in)
Kerb weight (in running order)	194 kg (427.7 lb)

Engine

ENGINE

Specification	Desc./Quantity
Model	M34AM
Engine type	Single-cylinder, 4-stroke, with double spark plug
Cylinder quantity	1
Valve quantity	4
Overall engine capacity	492.7 cm ³
Bore/stroke	94 mm / 71 mm
Compression ratio	10.5 ± 0.5 : 1
Start-up	Electric
Engine revs at idle speed	1500 ± 100 rpm
Clutch	Automatic centrifugal dry clutch
Gears	Automatic
Valve clearance	Inlet: 0.15 mm Outlet: 0.15 mm
Cooling	forced-circulation air cooling driven by a centrifugal pump
Lubrication system	Forced lubrication with trochoidal pump (inside the crankcase), oil filter and pressure adjustment by-pass
Throttle body	Ø 40 mm (1.57 in)
Throttle body diffuser	Ø 38 mm (1.50 in)
Fuel supply	By electronic injection with electric fuel pump
Fuel	Unleaded premium petrol (4 Stars UK) with minimum octane rating of 95 (NORM) and 85 (NOMM)
Ignition	CDI / inductive
Ignition advance	Variable advance controlled by the injection control unit
Spark plug	NGK - CR7EKB
Spark plug electrode gap	0.7 - 0.9 mm

Transmission

TRANSMISSION

Specification	Desc./Quantity
Variator	Continuous, automatic
Primary drive	V-belt
Secondary	With gears
Engine/wheel total ratio	
- short	1/14.083
- long	1/5.406

Capacities

CAPACITY

Specification	Desc./Quantity
Fuel (reserve included)	13.2 l (3.48 gal)
Fuel reserve	3 l (0.79 gal)
Engine oil change and engine oil filter replacement	1700 cm ³ (103.74 cu.in)
Transmission oil	250 cm ³ (15.256 cu.in)
Coolant	1.7 l
Seats	2
Vehicle max. load (rider + luggage)	115 kg (253.5 lb)
Vehicle max. load (rider + passenger + luggage)	190 kg (418.9 lb)
Oil for front fork	230 cm ³ (for each stem)

Electrical system

ELECTRICAL SYSTEM

Specification	Desc./Quantity
Battery	12V - 12 Ah
Fuses	30- 15- 10A
(Permanent magnet) Generator	14V - 380W

BULBS/ WARNING LIGHTS

	Specification	Desc./Quantity
1	High-/low-beam bulb	12V - 55W / 12V - 55W
2	Front parking light bulb	12V - 5W
3	Rear/front turn indicator bulb	12V - 10W (rear)/ 12V - 10W (front)
4	Rear tail light /stop light bulb	12V - 5W/21W
5	License plate light bulb	12V - 5W
6	Instrument panel lighting bulb	LED
7	Turn indicator warning light	LED
8	Engine oil pressure warning light	LED
9	Low-beam warning light	LED
10	High-beam warning light	LED
11	Low fuel warning light	LED
12	High coolant temperature gauge warning light	LED

Frame and suspensions

CHASSIS AND SUSPENSIONS

Specification	Desc./Quantity
Type	high-resistant steel tubes
Steering inclination angle	27.5°
Trail	108 mm (4.25 in)
Front suspension	Hydraulic action telescopic fork
Front suspension travel	104 mm (4.09 in)
Rear suspension	Two double-acting hydraulic shock absorbers, with preloading adjustment

Specification	Desc./Quantity
Rear suspension travel	100 mm (3.94 in)

Brakes

BRAKES

Specification	Desc./Quantity
Front brake	Ø 260 mm (10.236 in) disc brake with hydraulic transmission
Rear brake	Double disc - front: Ø 260 mm (10.236 in) / rear: 240 mm (9.449 in)

Wheels and tyres

WHEELS AND TYRES

Specification	Desc./Quantity
Rims	made of light alloy
Front wheel rim	16 x 3.00" made of light alloy
Rear wheel rim	14 x 4.5" made of light alloy
Tyres	Without inner tube (Tubeless)
Front tyre	110/70 16" 52S Tubeless
Rear tyre	150 /70 -14" 66S Tubeless
Front tyre pressure (rider only)	2.2 bar
Rear tyre pressure (rider only)	2.2 bar
Front tyre pressure (passenger + rider)	2.2 bar
Rear tyre pressure (passenger + rider)	2.3 bar

Tightening Torques

BRAKING SYSTEM UNIT

Name	Torque in Nm
Screw fixing the rear brake pump to the handlebar	10
Screw fixing the throttle control to the front brake pump	10
Screw fixing the right light switch to the brake pump	1
Screw fixing the left light switch to the brake pump	1
Anti-vibration weight fixing screw	10
Screw fixing the brakeforce distribution mechanism to the chassis	10
Screw fixing the rear brake calliper to the calliper support	25
Screw fixing the rear brake pipe to the chassis	10
Front brake calliper fixing screw	25
Brake fluid pipe-calliper fitting	20 ÷ 25

ENGINE UNIT

Name	Torque in Nm
Cable harness plate fixing screw	10
Variator cover fixing screw	10

Name	Torque in Nm
Filter casing support fixing screw	12
Starter motor cable fixing nut	5
Starter motor retainers	11 ÷ 13
Rear brake calliper support fixing screw	25
Nut fixing the rear brake disc to the hub	12
Muffler plate-engine fixing nut	50
Filter casing intake sleeve clamp to engine retainer	3
Screw fixing the filter casing to the rear mudguard	6
Screw fixing the filter casing to the engine support	3

EXHAUST SYSTEM UNIT

Name	Torque in Nm
Lambda probe to exhaust manifold retainer	45
Nut fixing the exhaust manifold to the engine	15
Silencer clamp to exhaust manifold retainer	17
Screw fixing the silencer to the plate	25
Silencer clamp lock nut to plate retainer	12
Screw fixing the silencer clamp to the plate	11 - 13
Muffler cover fixing screw	12

ENGINE LINK ROD UNIT

Name	Torque in Nm
Pin fixing the connecting rod to the chassis on threaded bushing	10
Nut fixing the connecting rod pin to the right-side chassis	70
Lock nut fixing the connecting rod pin to the left-side chassis	45
Nut fixing the connecting rod pin to the left-side engine	110
Nut fixing the tie rod to the engine	70
Nut fixing the tie rod to the chassis	40

FRONT SUSPENSION

Name	Torque in Nm
Fork nut	15
Fork lock nut	42
Fork hub fixing screw	10
Front mudguard attachment fixing screw	10

HANDLEBAR UNIT

Name	Torque in Nm
Nut fixing the handlebar to the fork	50

STAND UNIT

Name	Torque in Nm
Nut fixing the centre stand to the chassis	30
Nut fixing the side stand to the chassis	25

COOLING SYSTEM UNIT

Name	Torque in Nm
Screw fixing the radiator to the chassis	10

Name	Torque in Nm
Screw fixing the electric fan support to the radiator	5
Pump/ radiator hose clamp retainer	3
Radiator cap retainer	20
Nut fixing the electric fan support clamp	5
Retainers for head/ radiator hose clamps	3
Screw fixing the electric fan to the radiator	5

REAR WHEEL UNIT

Name	Torque in Nm
Screw fixing the rear wheel to the hub	35
Rear wheel fixing nut	120

REAR SUSPENSION UNIT

Name	Torque in Nm
Right/left shock absorber support fixing nut	25
Right/left shock absorber fixing nut	40

TANK UNIT

Name	Torque in Nm
Screw fixing the fuel tank to the chassis	10
Fuel tank support front fixing screw	25
Fuel tank support rear fixing screw	25
Fuel pipe fixing screw	5
Expansion tank support fixing screw	5
Expansion tank fixing screw	5

FRAME ASSEMBLY

Name	Torque in Nm
Screw fixing the right/left rider footrest gusset	10
Nut fixing the coil to the left rider footrest gusset	10
Screw fixing the rear curved support to the chassis	25
Screw fixing right/left passenger footrest support	25

ELECTRICAL SYSTEM UNIT

Name	Torque in Nm
Screw fixing the linear switch to the chassis	6
Screw fixing the control unit to the chassis	6
Screw fixing the HV coil to the coil supporting bracket	2
Screw fixing the relay supporting bracket to the chassis	6
Screw fixing ground leads to the chassis	10
Screw fixing the saddle lock plate to the glove-box	1
Nut fixing the electro-actuator to the saddle lock plate	1
Nut fixing the return lever to the saddle lock plate	3
Self-tapping screw fixing the glove-box light glass to the glove-box	1
Screw fixing the saddle lock to the glove-box	4
Screw fixing the voltage regulator bracket with the horn	10
Voltage regulator fixing screw	10

Name	Torque in Nm
Self-tapping screw fixing the glove-box light switch to the glove-box	1
Nut fixing the starter motor cable to the relay	5
Nut fixing the battery cable to the starter motor relay	5
Self-tapping screw fixing the antitheft control unit to the chassis	1
Self-tapping screw fixing the connector clamp to the antitheft device	1
Odometer sensor fixing nut	10

REAR BODYWORK UNIT

Name	Torque in Nm
Screw fixing the rear mudguard to the muffler plate	10
Screw fixing the license plate holder to the chassis and to the glove-box	4
Screw fixing the license plate holder to the license plate holder curved support	6
Self-tapping screw fixing right/left tail sections to the glove box	1.5
Self-tapping screw fixing right/left tail sections to the right/left footrest	1.5
Self-tapping screw fixing rear light support	1.5
Rear light fixing screw	1
Luggage rack fixing screw	25
Luggage rack central fixing screw	25
Self-tapping screw fixing the luggage rack cover	0.6
Self-tapping screw fixing the right turn indicator to the tail section	1
Self-tapping screw fixing the left turn indicator to the tail section	1
Screw fixing the license plate light support to the license plate holder	5
License plate light fixing screw	1
Self-tapping screw fixing the right fairing to the tail section	1
Self-tapping screw fixing the left fairing to the tail section	1

CENTRAL BODYWORK UNIT

Name	Torque in Nm
Screw fixing the glove-box to the chassis	8
Screw fixing the right/left footrest to the right/left rider footrest gusset	4
Screw fixing the right/left footrest to the radiator grille	2
Screw fixing the internal shield to the side half-panel and to the tunnel	3
Bag hook fixing screw	1
Screw fixing the saddle hinge to the saddle	5
Screw fixing the spark plug access cover	2
Screw fixing the spark plug access cover	1
Self-tapping screw fixing the right/left object-carrying net to the shield	1

Name	Torque in Nm
Screw fixing the glove-box lid frame to the lid	1.5
Screw fixing the bracket to the glove-box lid	0.6
Self-tapping screw fixing the bracket to the fuel cap lid	0.6
Self-tapping screw fixing the glove-box lid to the shield	1
Self-tapping screw fixing the fuel cap lid to the tunnel	0.6
Self-tapping screw fixing the tab support	0.6

FRONT BODYWORK UNIT

Name	Torque in Nm
Self-tapping screw fixing the air vent grille to the right lateral half-panel	0.6
Self-tapping screw fixing the air vent grille to the left lateral half-panel	0.6
Screw fixing the lateral half-panel to the right radiator grille	1
Screw fixing the lateral half-panel to the left radiator grille	1
Tunnel fixing screw	2
Front mudguard fixing screw	10

FRONT BODYWORK UNIT

Name	Torque in Nm
Self-tapping screw fixing the ornament to the case	1
Washers to key switch cover to shield retainer	-
Screw fixing the right/left turn indicator to the cover	1.5
Right stem cover fixing screw (TCB 4.2x16)	1
Right stem cover fixing screw (TBEI M5x16)	2
Left stem cover fixing screw (TBEI M5x16)	2
Left stem cover fixing screw (TCB 4.2x16)	1
Screw fixing the right/left turn indicators to the half-panels	0.5
Case fixing screw	1
Screw fixing the internal shield to the chassis	2
Screw fixing the radiator grille to the chassis	8
Screw fixing the radiator grille to the chassis	4
Washers to right/left turn indicator cover retainer	-
Case fixing screw	2

LOCK UNIT

Name	Torque in Nm
Nut fixing the lock lever pin to the chassis	3
Screw fixing the fuel tank lid lock	2
Self-tapping screw fixing the tab to the tunnel	0.5

HEAD INSTRUMENT PANEL UNIT

Name	Torque in Nm
Screw fixing the front headlamp to the handlebar	3
Screw fixing the headlamp panel the to instrument panel	1.5

Name	Torque in Nm
Self-tapping screw fixing the instrument panel to the panel	1
Self-tapping screw fixing the front headlamp ring nut	1
Self-tapping screw fixing the instrument panel to the handlebar	1.5
Self-tapping screw fixing the instrument panel to the ring nut	1

FRONT WHEEL UNIT

Name	Torque in Nm
Wheel bolt retainer	70

THERMAL GROUP AND TIMING SYSTEM

Name	Torque in Nm
Spark plug	12 ÷ 14
Head fixing stud bolts	***
Head fixing nuts	10 - 12
Exhaust/ intake head fixing nuts	10 - 12
Head lubrication control jet	5 - 7
Coolant temperature sensor	10 ÷ 12
mass counterweight fixing screw	7 - 8.5
Tensioner pad fixing screw	10 - 14
Rpm timing sensor fixing screw	3 - 4
injector fixing screw	3 ÷ 4
Rpm-timing sensor fixing screw	3 ÷ 4
Screw fixing the valve-lifter retaining cover	30 - 35
inlet manifold fixing screws	11 - 13
Tappet cover fixing screws	7 - 9
Throttle body fixing screws	11 ÷ 13
Camshaft retaining bracket fixing screws	4 - 6
Head fixing screws	10 - 12
Lambda probe on exhaust manifold	10 - 12
Screw fixing the muffler to the bracket	14 - 16

*** First, apply a preliminary torque of 7 Nm in a criss-crossed sequence. - tighten 90° in a criss-crossed sequence. - tighten again 90° in a criss-crossed sequence.

CRANKCASE AND CRANKSHAFT

Name	Torque in Nm
Countershaft fixing nut	25 ÷ 29
Engine oil filter	12 ÷ 16
Engine oil drainage plug	24 ÷ 30
Engine crankcase coupling screws	11 ÷ 13
Oil pump screws	5 ÷ 6
Gear on crankshaft screws	10 - 12
Oil pump compartment cover bulkhead screws	8 - 10

FINAL REDUCTION

Name	Torque in Nm
Rear hub cover screws	24 ÷ 27

TRANSMISSION COVER

Name	Torque in Nm
Driven pulley nut	92 - 100
Driving pulley nut	160 - 175
Anti-flapping roller screw	16.7 ÷ 19.6
Transmission cover M8 retainers	23 ÷ 26
M6 Retainer	11 ÷ 13
Anti-flapping roller retainer	17 - 19
Clutch ring nut	65 - 75
Complete air deflector screws	7 ÷ 9
Water pump cover screws	3 ÷ 4
External transmission cover screws	7 ÷ 9
Flywheel cover screws	11 - 13

FLYWHEEL COVER

Name	Torque in Nm
Flywheel fixing nut	115 - 125
Stator clamps	8 - 10
Blow-by scavenge duct fixing screws	3 - 4
Screws fixing freewheel to flywheel	13 - 15
Stator cable harness guide bracket screws	3 - 4

LUBRICATION

Name	Torque in Nm
Oil pump cover screws	0.7 ÷ 0.9
Screws fixing oil pump to crankcase	5 ÷ 6

Overhaul data

This section provides the main information to carry out regular maintenance operations on your vehicle.

Assembly clearances

Cylinder - piston assy.

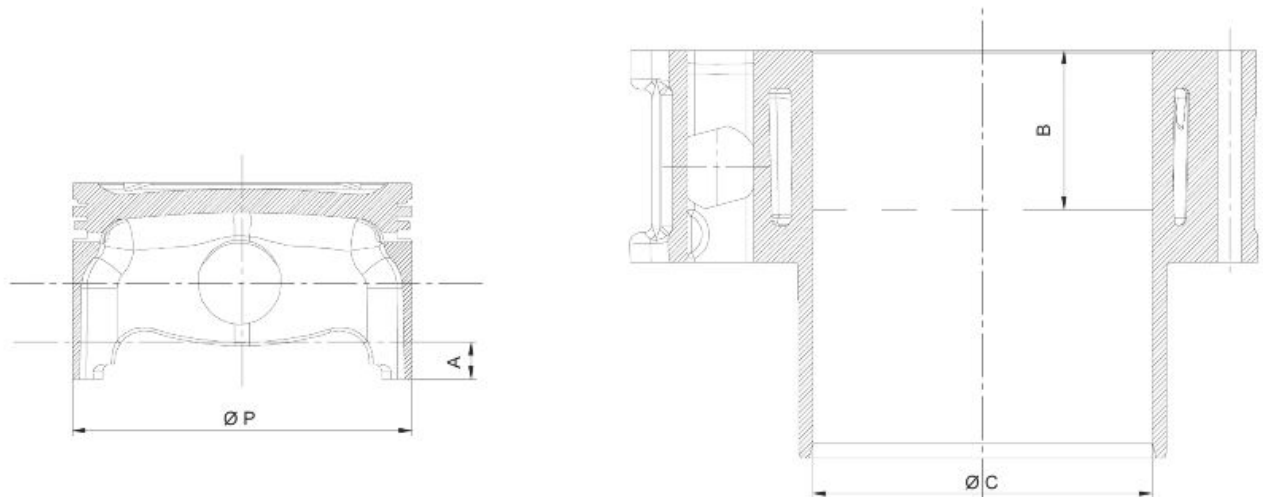

HEIGHT AT WHICH THE PISTON SHOULD BE MEASURED

Specification	Desc./Quantity
A	10 mm (0.393 in)
B	43 mm (1.69 in)

CYLINDER-PISTON

Specification	Desc./Quantity
Cylinder Ø C	94+0.018-0.01
Piston Ø P	93.968±0.014

COUPLING CATEGORIES

Name	Initials	Cylinder	Piston	Play on fitting
Cylinder - Piston	A	93.990 ÷ 93.997	93.954 ÷ 93.961	0.029 ÷ 0.043
Cylinder - Piston	B	93.997 ÷ 93.004	93.961 ÷ 93.968	0.029 ÷ 0.043
Cylinder - Piston	C	94.004 ÷ 94.011	93.968 ÷ 93.975	0.029 ÷ 0.043
Cylinder - Piston	D	94.011 ÷ 94.018	93.975 ÷ 93.982	0.029 ÷ 0.043

NOTE

THE PISTON MUST BE FITTED WITH THE ARROW FACING TOWARDS THE EXHAUST SIDE, THE PISTON RINGS MUST BE FITTED WITH THE REFERENCE «TOP» OR THE STAMPED MARK FACING UP.

Piston rings

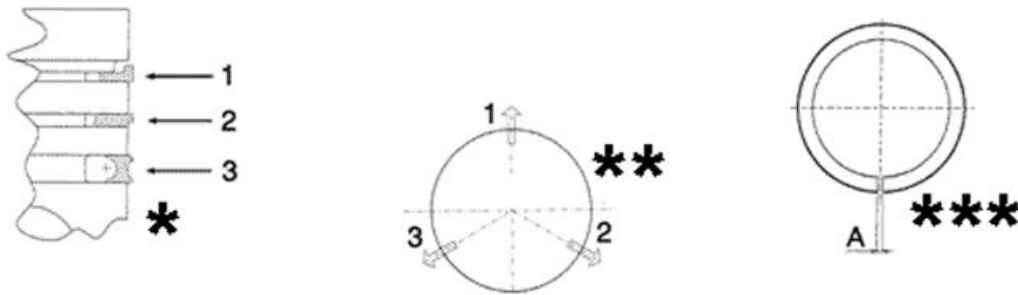

* Fit piston rings «2» and «3» with the mark «TOP» facing up.

** Position the port in the piston rings as shown in this figure.

*** Value «A» of the sealing ring inside the cylinder.

Check the size of the sealing ring opening:

Compression ring: 0.15 ÷ 0.35 mm. Max. value: 0.5 mm

Oil scraper ring: 0.25 ÷ 0.50 mm. Max. value: 0.65 mm

Oil scraper ring: 0.25 ÷ 0.50 mm. Max. value: 0.65 mm

Rings/slots coupling clearances:

Carefully clean the sealing ring housings.

Check coupling clearances by placing a thickness gauge between the ring and the slot as shown in the figure.

Top ring: Standard coupling clearance:

0.01÷0.06 mm

Maximum clearances allowed after use: 0.10

mm

Middle ring: Standard coupling clearance:

0.02÷0.07 mm

Maximum clearances allowed after use: 0.10

mm

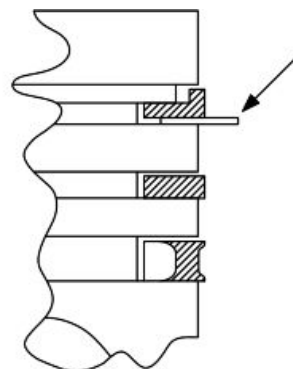

Oil scraper ring: Standard coupling clearance: 0.01±0.06 mm

Maximum clearances allowed after use: 0.10 mm

If clearances measured exceed the maximum values specified in the table, the piston should be replaced with a new one.

Crankcase - crankshaft - connecting rod

Crankshaft bearing diameter.

Measure the bearings on both axes, X-Y

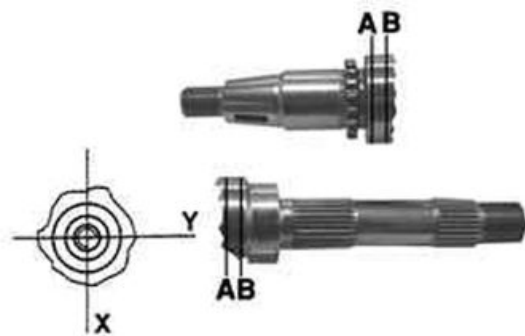

CRANKSHAFT

Specification	Desc./Quantity
Cat. 1	Standard diameter: 40.010 ÷ 40.016
Cat. 2	Standard diameter: 40.016 ÷ 40.022

Crankshaft alignment

Specific tooling

020335Y Dial gauge magnetic support

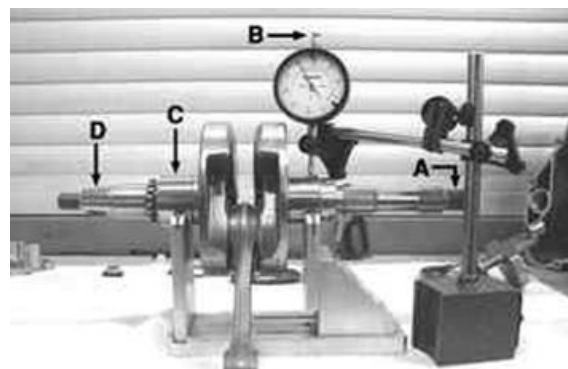

MAXIMUM OFF-LINE ALLOWED

Specification	Desc./Quantity
A =	0.15 mm
B =	0.010 mm
C =	0.010 mm
D =	0.10 mm

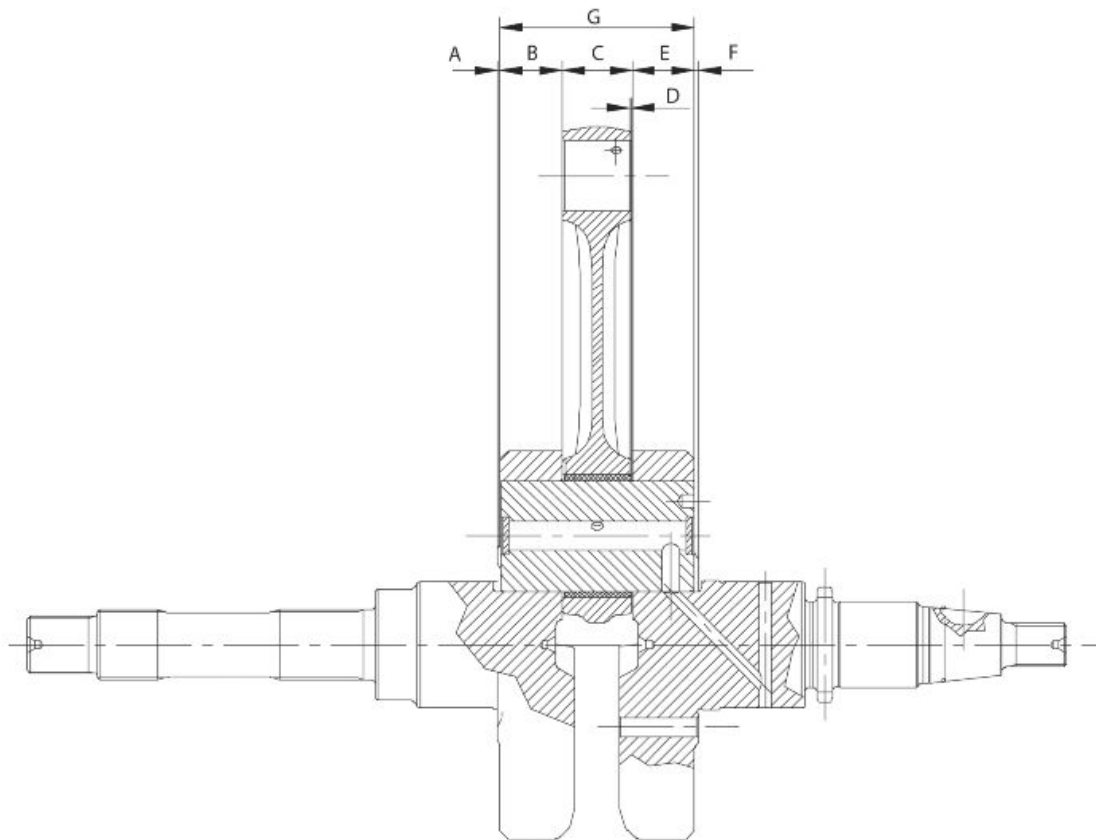

CRANKSHAFT / CONNECTING ROD AXIAL CLEARANCE

Name	Description	Dimensions	Initials	Quantity
Transmission-side shoulder		1 ± 0.025	A	$D = 0.20 \div 0.50$
Half-shaft, transmission side		$20.9 - 0.05$	B	$D = 0.20 \div 0.50$
Connecting rod		$22-0.10 - 0.15$	C	$D = 0.20 \div 0.50$
Flywheel-side shoulder		1.8 ± 0.025	F	$D = 0.20 \div 0.50$
Half-shaft, flywheel side		$19.6 - 0.05$	E	$D = 0.20 \div 0.50$
Complete crankshaft		$65.5 +0.1 -0.05$	G	$D = 0.20 \div 0.50$

- Measure the diameter of bushings «A» at the three positions indicated in the figure.
- Measure the diameter of crankshaft bearings «B».
- Check that diametral clearance «A-B» is within the pre-set gap.

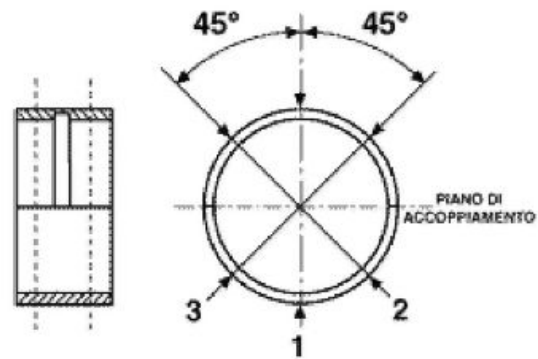

Characteristic

Diametral clearance

0.025 ÷ 0.043 mm

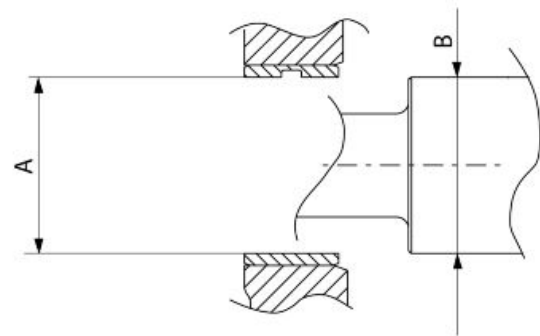

If value «A-B» exceeds the limit value, check that value «B» is within the values allowed for the categories.

CRANKSHAFT

Specification	Desc./Quantity
Type 2	40.026 ÷ 40.032
Type 1	40.020 ÷ 40.026

If the crankshaft is within the set limits, replace the crankshaft half-bearings arranging the crankshaft so as to match the specified couplings. The crankcase halves can be equipped with four types of crankshaft half-bearings identified by letters A (red), B (blue), C (yellow) and D (green).

CRANKCASE

Specification	Desc./Quantity
Type 1	43.974 ÷ 43.980
Type 2	43.980 ÷ 43.986
Type 3	43.986 ÷ 43.992

CRANKCASE - CRANKSHAFT COUPLING / CRANKSHAFT HALF-BEARINGS

Specification	Desc./Quantity
Crankshaft Type 1 - Crankcase Type 1	B + B, A+C
Crankshaft Type 2 - Crankcase Type 1	A+A
Crankshaft Type 1 - Crankcase Type 2	C + C, B+D
Crankshaft Type 2 - Crankcase Type 2	B + B, A+C
Crankshaft Type 1 - Crankcase Type 3	D+D
Crankshaft Type 2 - Crankcase Type 3	C + C, B+D

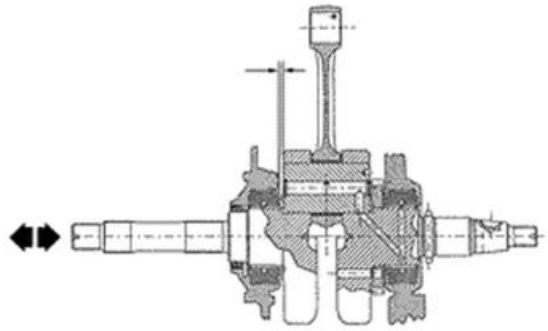

Characteristic

Crankshaft-crankcase axial clearance:

0.1 ÷ 0.405 mm

Slot packing system

Shimming system to control the compression ratio

MEASUREMENT «A» IS A PROTRUSION OR RECESS VALUE OF THE PISTON CROWN COMPARED WITH THE CYLINDER PLANE. MEASUREMENT «A» ALLOWS TO DETERMINE THE THICKNESS OF GASKET «B» THAT HAS TO BE FITTED INTO THE CYLINDER BASE IN ORDER TO RESTORE THE COMPRESSION RATIO. THE MORE THE PLANE FORMED BY THE PISTON CROWN PROTRUDES BEYOND THE PLANE FORMED BY THE CYLINDER UPPER END, THE THICKER THE GASKET TO BE USED AT THE CYLINDER BASE «B» SHOULD BE. ON THE OTHER HAND, THE MORE THE PISTON CROWN IS RECESSED INTO THE CYLINDER TOP PLANE, THE SMALLER THE GASKET THICKNESS.

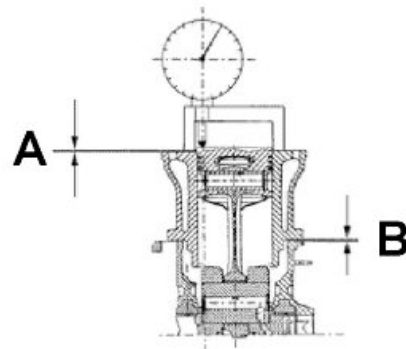

Characteristic

Compression ratio

10.5: 1

BASE GASKET THICKNESS

Name	Measure A	Thickness
MEASURE TAKEN «A»	- 0.185 ÷ - 0.10	0.4 ± 0.05
MEASURE TAKEN «A»	- 0.10 ÷ + 0.10	0.6 ± 0.05
MEASURE TAKEN «A»	+ 0.10 ÷ + 0.185	0.8 ± 0.05

NOTE

VALUES INDICATED WITH «-» REFER TO RECESSES OF THE PISTON CROWN FROM THE CYLINDER PLANE.

NOTE

SIZE «A» MUST BE MEASURED WITHOUT ANY GASKET FITTED AT «B»

Products

RECOMMENDED PRODUCTS TABLE







Product	Description	Specifications
AGIP CITY HI TEC 4T	Engine oil	SAE 5W-40, API SL, ACEA A3, JASO MA Synthetic oil
AGIP GEAR SYNTH	Gearbox oil	SAE 75W-90, API GL4, GL5 Synthetic oil
AGIP FORK 7.5W	Fork oil	-
AGIP GREASE SM2	Lithium grease with molybdenum for bearings and other points needing lubrication	NLGI 2
AGIP BRAKE 4	Brake fluid	FMVSS DOT 4 Synthetic fluid
AGIP PERMANENT SPEZIAL	Coolant	Biodegradable coolant, ready for use, with "long life" technology and characteristics (pink). Freezing protection up to -40°C. According to CUNA 956-16 standard.







INDEX OF TOPICS

TOOLING

TOOL

SPECIFIC TOOLS

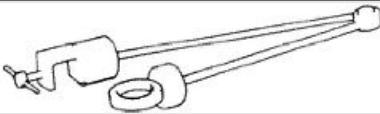
Stores code	Description	
001467Y002	Driver for bearing with OD 73 mm	
001467Y006	Pliers to extract 20-mm bearings	
001467Y007	Driver for bearings with OD 54 mm	
001467Y008	Pliers to extract Ø 17-mm bearings	
001467Y014	Pliers to extract Ø 15-mm bearings	
001467Y031	Driver	

Stores code	Description	
001467Y034	Pliers to extract Ø 15-mm bearings	
001467Y035	Driver for bearings with OD 47 mm	
020074Y	Supporting base for checking crankshaft alignment	
020151Y	Air heater	
020150Y	Air heater support	
AP8140181	Fuel pressure check tool	
020262Y	Crankcase splitting strip	

Stores code	Description
-------------	-------------

020306Y

Punch for fitting valve sealing rings



020329Y

Mity-Vac vacuum pump

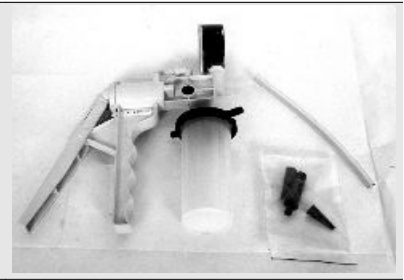

020330Y

Stroboscopic light for timing checking



020331Y







Digital multimeter













020335Y

Dial gauge magnetic support

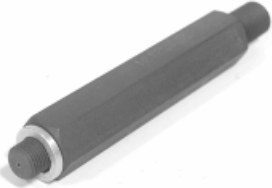

Stores code	Description	
020357Y	32 x 35 mm adaptor	
020358Y	37 x 40 mm adaptor	
020359Y	42 x 47 mm adaptor	
020360Y	52 x 55 mm adaptor	
020363Y	20-mm guide for oil seal	
020364Y	25-mm guide	

Stores code	Description	
020375Y	28 x 30 mm adaptor	
020376Y	Adaptor handle	
020382Y012	bushing (valve removing tool)	
020382Y	Tool for removing valve cotters fitted with part 012	
020412Y	15-mm guide	
020431Y	Valve oil seal extractor	

Stores code	Description	
020424Y	Punch to fit driven pulley roller casing	
020434Y	Fitting for oil pressure check	
020439Y	17-mm guide	
AP8140259	Tool for fitting/removing the clutch on the driven pulley	
020456Y	Ø 24-mm adaptor	
AP8140595	Axone + battery charger (230V 50Hz)	

Stores code	Description	
AP8202311	Axone + battery charger (110V 60Hz)	

020467Y

Flywheel extractor



020468Y	Piston fitting ring	
---------	---------------------	--------------------------------------------------------------------------------------

020470Y

Pin snap ring fitting tool







020471Y	Pin for countershaft timing	
---------	-----------------------------	---------------------------------------------------------------------------------------



020472Y

Flywheel lock wrench

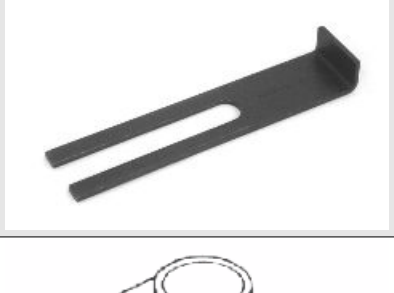
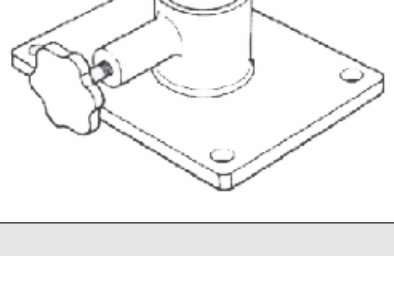

Stores code	Description	
020474Y	Driving pulley lock wrench	
020475Y	Piston position checking tool	
020476Y	Stud bolt set	
020477Y	37-mm adaptor	
020478Y	Punch for roller casing	
020479Y	Countershaft lock wrench	

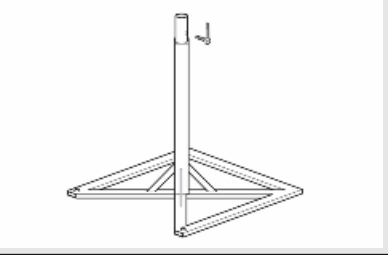
Stores code	Description	
020480Y	Fuel pressure check kit	
020481Y	Adaptor cable harness	
020482Y	Engine support	
020483Y	30-mm guide	
020512Y	Piston fitting fork	
020527Y	Engine supporting base	
020604Y011	Adaptor for fitting	

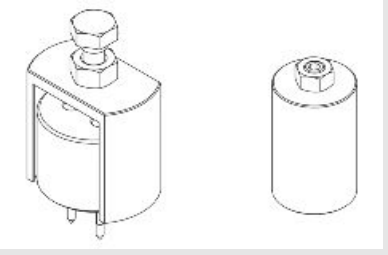
Stores code	Description	
AP8106702	Flywheel lock calliper spanner	
AP8140187	Engine supporting stand	
020648Y	Single battery charger	
020661Y	Water pump overall sealing replacement kit	

INDEX OF TOPICS

MAINTENANCE

MAIN

Maintenance chart

EVERY 2 YEARS

60'

Action

coolant - replacement
Brake fluid - change

AFTER 1,000 KM

60'

Action

Safety locks - check
Throttle lever - adjustment
Engine oil filter - replacement
Electrical system and battery - check
Coolant level - check
Brake fluid level - check
Engine oil - change
Brake pads - condition and wear check
Tyre pressure and wear - check
Vehicle and brake test - test drive
Hub oil - change
Steering - check

AFTER 5,000 KM; 25,000 KM; 35,000 KM; 55,000 KM; 65,000 KM

10'

Action

Engine oil - level check/topping-up
Brake pads - condition and wear check
Centre stand - lubrication

AFTER 10,000 KM; 50,000 KM; 70,000 KM

120'

Action

Safety locks - check
Driving belt - replacement
Throttle lever - adjustment
Air filter - cleaning
Engine oil filter - replacement
Electrical system and battery - check
Coolant level - check
Brake fluid level - check
Engine oil - change
Brake pads - condition and wear check
Sliding blocks/ variable speed rollers - replacement
Tyre pressure and wear - check
Vehicle and brake test - test drive
Hub oil - check
Suspensions - check
Steering - check
Centre stand - lubrication

Action

Spark plugs - replacement

AFTER 15,000 KM; 45,000 KM; 75,000 KM

45'

Action

Engine oil - level check/topping-up

Brake pads - condition and wear check

Centre stand - lubrication

AFTER 20,000 KM; AFTER 40,000 KM; AFTER 60,000 KM AND AFTER 80,000 KM

190'

Action

Spark plugs - replacement

Driving belt - replacement

Throttle lever - adjustment

Air filter - check

Engine oil filter - replacement

Valve clearance - check

Electrical system and battery - check

Coolant level - check

Engine oil - change

Brake pads - condition and wear check

Sliding blocks/ variable speed rollers - replacement

Tyre pressure and wear - check

Vehicle and brake test - test drive

Hub oil - change

Suspensions - check

Steering - check

Centre stand - lubrication

Brake fluid level - check

30,000 KM

200'

Action

Safety locks - check

Driving belt - Replacement

Throttle lever - adjustment

Air filter - cleaning

Engine oil filter - replacement

Electrical system and battery - check

Coolant level - check

Brake fluid level - check

Engine oil - change

Hub oil - check

Brake pads - condition and wear check

Sliding blocks/ variable speed rollers - replacement

Tyre pressure and wear - check

Vehicle and brake test - test drive

Suspensions - check

Steering - check

Centre stand - lubrication

Spark plugs - replacement

Spark plug

Check spark plugs according to the scheduled maintenance table.

At regular intervals, remove spark plugs and clean off any carbon deposits or replace, if required.

To access spark plugs remove the inspection cover as follows:

- Lift the saddle.
- Remove the battery cover. Undo and remove the two screws «1» fixing the central inspection cover.
- Lower the saddle.
- Undo and remove the lower central fixing screw «2».
- Slide off the central inspection cover.

For removal and cleaning:

CAUTION



BEFORE CARRYING OUT THE FOLLOWING OPERATIONS AND IN ORDER TO AVOID BURNS, LEAVE THE ENGINE AND MUFFLER TO COOL OFF TO AMBIENT TEMPERATURE.

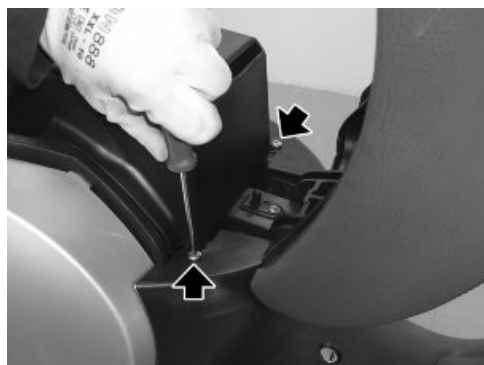

- Disconnect the caps «3» of the high voltage cables from the spark plug.
- Clean off any trace of dirt from the spark plug base by blowing compressed air. Unscrew the spark plugs and remove them from their seat, being careful not to let dust or any other substance come into the cylinder.
- Check that the spark plug electrode and the centre porcelain are free of carbon deposits or signs of corrosion. If necessary, clean using suitable spark plug cleaners, a wire and/or metal brush.
- Blow with a strong air blast to avoid removed dirt getting into the engine. Replace the spark plug if there are cracks on its insulating material, corroded electrodes or large deposits.
- Check electrode gap with a thickness gauge and adjust if necessary by carefully bending the earth electrode.
- Make sure the washer is in good conditions. Once the washer is fitted, finger tight the spark plug to avoid damaging the thread.
- Tighten to the specified torque.
- Insert the spark plug tube correctly so that it does not get detached due to engine vibrations.
- Refit the inspection cover.

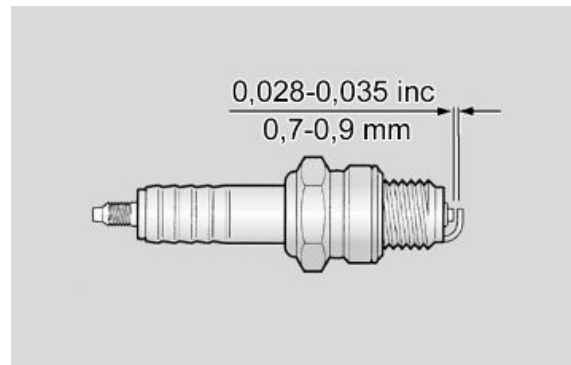
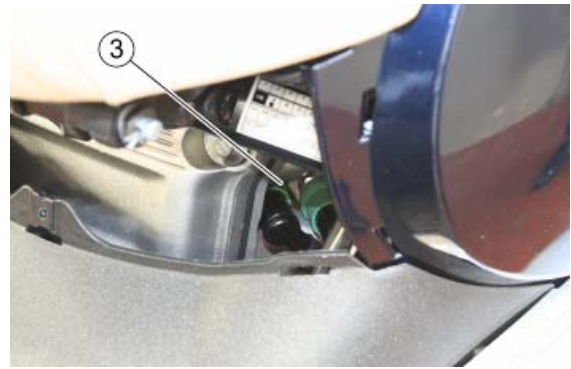
**CAUTION**

TIGHTEN THE SPARK PLUG CORRECTLY, OTHERWISE THE ENGINE MAY OVERHEAT AND GET IRRETRIEVABLE DAMAGED. USE SPARK PLUGS OF THE RECOMMENDED TYPE ONLY. OTHERWISE, ENGINE LIFE AND PERFORMANCE COULD BE COMPROMISED.

Characteristic**Spark plug electrode gap**

0.7 - 0.9 mm

Locking torques (N*m)

Spark plug 12 ÷ 14

Hub oil**Check****NOTE****USE RECOMMENDED OIL ONLY. REFER TO THE RECOMMENDED PRODUCTS TABLE.**

- Ride a few kilometres until the regular working temperature is reached, then stop the engine.
- Park the vehicle on firm and level ground.
- Rest the vehicle on its centre stand.

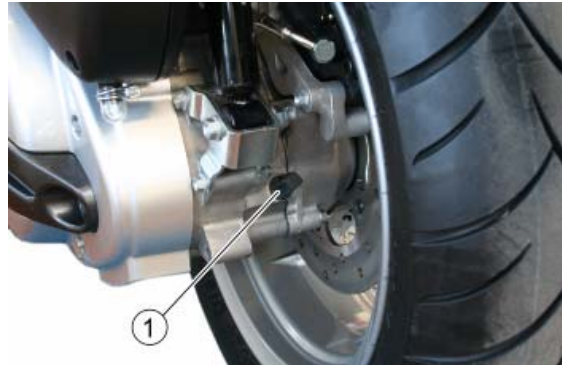

- Unscrew and take out the measuring cap-dipstick «1».
- Clean the area in contact with oil with a clean cloth.
- Screw the cap-dipstick «1» fully down into its tube.
- Extract the cap-dipstick «1» again and read the oil level on the cap-dipstick:
 - The level is correct when it reaches approximately the first notch above the little round mark.

MAX = Maximum level**MIN** = Minimum level

- Top-up if necessary.

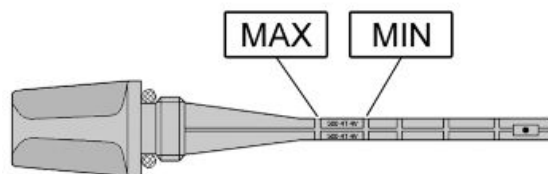
**TOP-UP**

- Pour a little oil through the dipstick tube and wait one minute so that the oil flows evenly into the crankcase.
- Top-up with small quantities of oil until the recommended level is reached.
- Check hub oil level, top-up if necessary.
- At the end of the operation, screw and tighten the cap-dipstick «1».

CAUTION

IN ORDER TO AVOID DAMAGING THE ENGINE, OIL LEVEL MUST NEVER EXCEED THE «MAX» MARK OR DROP BELOW THE «MIN» MARK.

CAUTION

RIDING THE VEHICLE WITH INSUFFICIENT LUBRICATION OR CONTAMINATED OR NOT RECOMMENDED LUBRICANTS ACCELERATES THE WEAR AND TEAR OF MOVING PARTS AND CAN CAUSE IRRETRIEVABLE DAMAGE.

Replacement

- Park the vehicle on firm and level ground.
- Rest the vehicle on its centre stand.

CAUTION

WAIT SOME MINUTES UNTIL THE ENGINE AND THE EXHAUST SYSTEM ARE COLD.

- Unscrew and take out the measuring cap-dipstick «1».

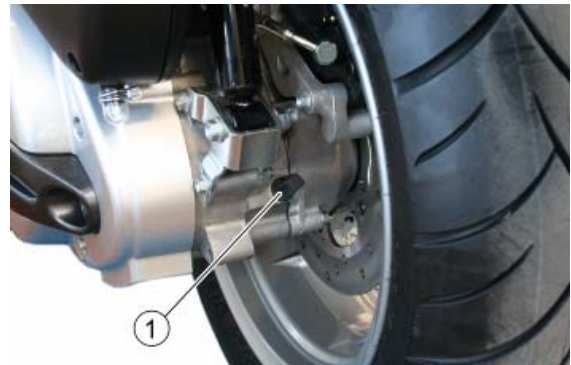

- Place a collecting container with +250 cm³ (15.3 cu.in) capacity under the drain screw «2».
- Undo and remove the drain screw.
- After having drained off the transmission oil, screw and tighten the drain screw «2».

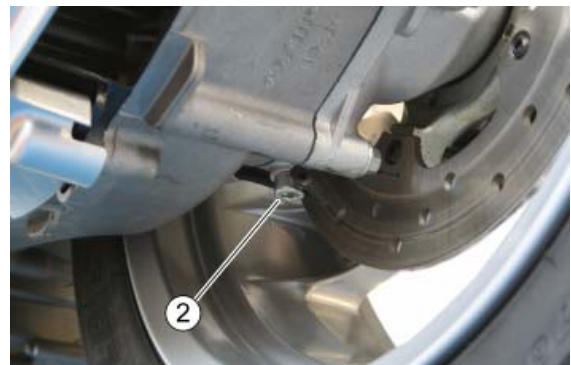

- Pour the indicated quantity of recommended transmission oil through the fill opening.
- Screw and tighten the measuring cap-dipstick «1».
- Start the engine and let it run for several minutes. Stop the engine and let it cool down.
- Check the transmission oil level again.

Recommended products

AGIP GEAR SYNTH SAE 75W-90 Gearbox oil

API GL4, GL5

Characteristic

Transmission oil

250 cm³ (15.3 cu.in)

Air filter

Remove the filtering element from the vehicle for cleaning.

Removal

- Rest the vehicle on its centre stand.
- Undo and remove the nine screws «1».

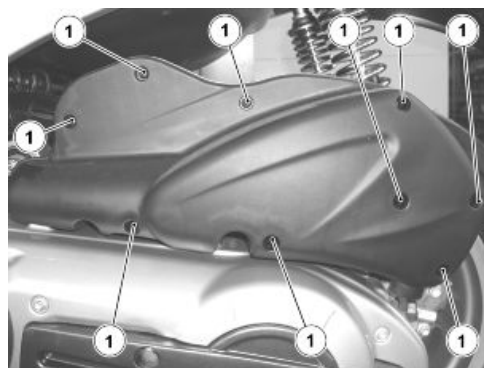

- Remove the filter casing cover with the filtering element
- Check the filtering element; replace it if required.

CAUTION



**CLEAN THE FILTERING ELEMENT WITH A JET OF COMPRESSED AIR.
DO NOT OIL THE FILTERING ELEMENT OR OIL MAY GET INTO THE BELT HOUSING AND DAMAGE IT OR CAUSE IT TO SLIDE.**



Engine oil

In 4T engines, engine oil is used to lubricate the distribution elements, the bench bearings and the thermal group.

In all 4T engines, a loss of efficiency in oil performance and some oil consumption should be considered normal, especially at the time of run-in. Consumption can particularly reflect the conditions of use (i.e.: when driving at "full speed" all the time, oil consumption increases).

CAUTION



OPERATING THE SCOOTER WITH INSUFFICIENT OIL CAN DAMAGE THE ENGINE.

Replacement

CAUTION



PARK THE VEHICLE ON SAFE AND LEVEL GROUND.

- Rest the scooter on its centre stand.

CAUTION



WAIT SOME MINUTES UNTIL THE ENGINE AND THE EXHAUST SYSTEM ARE COLD.

- Stop the engine and let it cool off so that the oil in the crankcase flows down and cools as well.
- Unscrew and take out the measuring cap-dipstick «1».

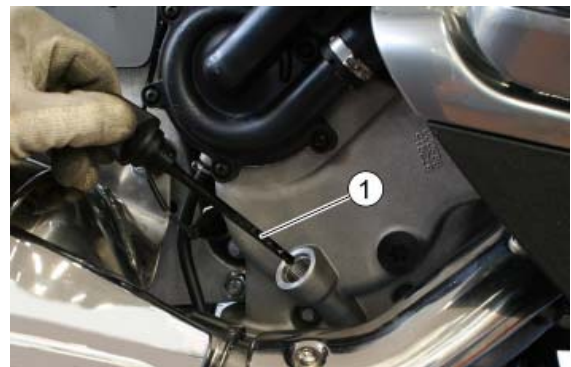

- Unscrew and remove the engine oil cartridge filter.

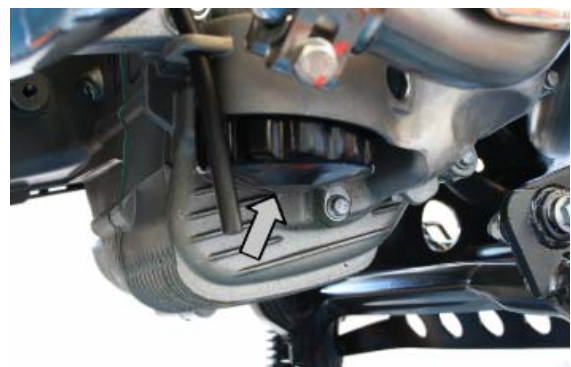

- Place a collecting container with +1700 cm³ (103.74 cu.in) capacity under the drainage plug «3».
- Unscrew and remove the oil drainage plug «3» and then drain all the engine oil into the collecting container.



- Fit a new engine oil cartridge filter and take special care to lubricate the filter sealing O-rings with oil.
- Screw and tighten the engine oil drainage plug «3» to the prescribed torque.



Locking torques (N*m)

Engine oil drainage plug 24 ÷ 30

- Pour the indicated quantity of recommended transmission oil through the fill opening.

Recommended products

AGIP CITY HI TEC 4T Engine oil

API SL, ACEA A3, JASO MA

Characteristic

Engine oil

1700 cm³ (103.74 cu.in).

- Screw and tighten the measuring cap-dipstick «1».
- Start the engine and let it run for several minutes. Stop the engine and let it cool down.
- Check engine oil level again.

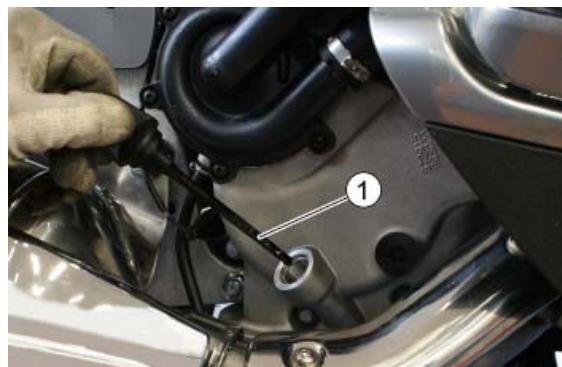

CAUTION

IF OIL IS CHANGED AT THE SAME TIME THE ENGINE OIL CARTRIDGE FILTER IS REPLACED, ADD APPROXIMATELY 1700 cm³ OF OIL.

IF THE OIL IS CHANGED BUT THE ENGINE OIL CARTRIDGE FILTER IS NOT REPLACED, ADD APPROXIMATELY 1500 cm³ OF OIL, INSTEAD OF 1700 cm³, SINCE PART OF THE LUBRICATION CIRCUIT IS STILL FILLED.

Check

NOTE

USE RECOMMENDED OIL ONLY. REFER TO THE RECOMMENDED PRODUCTS TABLE.

CAUTION



PARK THE VEHICLE ON SAFE AND LEVEL GROUND.

- Rest the vehicle on its centre stand.

CAUTION



WAIT SOME MINUTES UNTIL THE ENGINE AND THE EXHAUST SYSTEM ARE COLD.

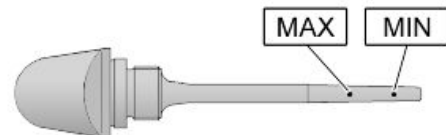

- Stop the engine and let it cool off so that the oil in the crankcase flows down and cools as well.

NOTE

FAILURE TO FOLLOW THESE OPERATIONS MAY RESULT IN AN INCORRECT READING OF THE ENGINE OIL LEVEL.

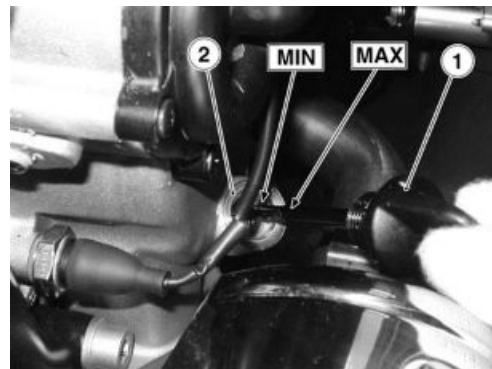

- Unscrew and pull out the measuring cap-dipstick «1».
- Clean the area in contact with oil with a clean cloth.
- Screw the cap-dipstick «1» fully down into its tube «2».
- Remove the cap-dipstick «1» again and read the level the oil reaches on the dipstick:

MAX = maximum level;

MIN = minimum level.

- The level is correct when it is close to the «MAX» level marked on the measuring dipstick.
- Top-up if necessary.

CAUTION



IN ORDER TO AVOID DAMAGING THE ENGINE, OIL LEVEL MUST NEVER EXCEED THE «MAX» MARK OR DROP BELOW THE «MIN» MARK.

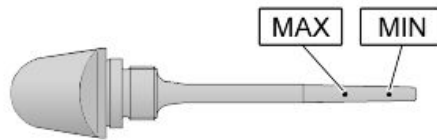

TOP-UP

- Pour a small quantity of oil through the tube «2» and wait approximately five minutes so that the oil flows evenly into the crankshaft.
- Top-up with small quantities of oil, until the recommended level is reached.
- Check the engine oil level; top-up if necessary
- At the end of the operation, screw and tighten the cap-dipstick «1».

CAUTION



RIDING THE VEHICLE WITH INSUFFICIENT LUBRICATION OR CONTAMINATED OR NOT RECOMMENDED LUBRICANTS ACCELERATES THE WEAR AND TEAR OF MOVING PARTS AND CAN CAUSE IRRETRIEVABLE DAMAGE.

Engine oil filter

CAUTION



DO NOT DISPOSE OF OIL INTO THE ENVIRONMENT. OIL, GASKET AND FILTER SHOULD BE DISPOSED OF ACCORDING TO THE REGULATIONS IN FORCE.

WARNING



AVOID TOUCHING PARTS OF THE ENGINE WHEN HOT, AS THIS MAY CAUSE BURNS.

- Remove the filler plug «1».

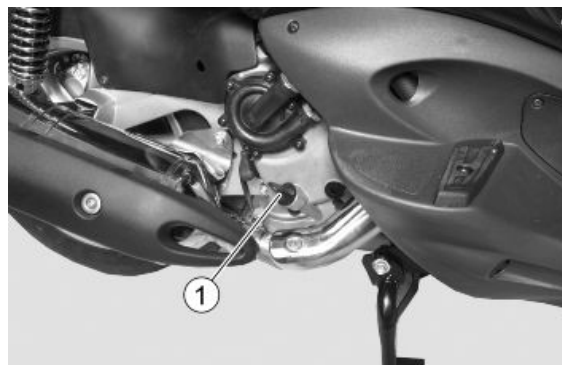

- Remove and clean the mesh pre-filter of the drainage plug «2» with compressed air.

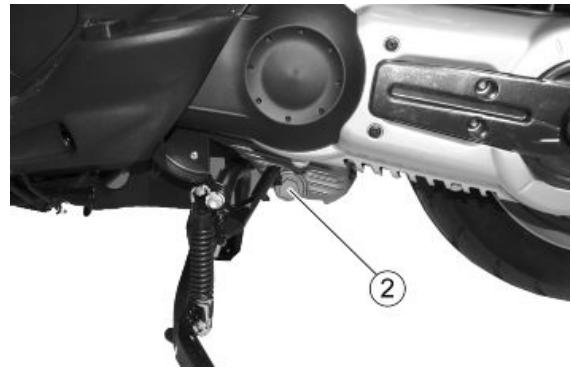

- With a strap-type oil filter wrench to remove the cartridge filter «3».
- Make sure the O-rings of the pre-filter and the drainage plug are in good conditions.
- Lubricate them and refit the mesh filter and the oil drainage plug. Tighten to the prescribed torque.

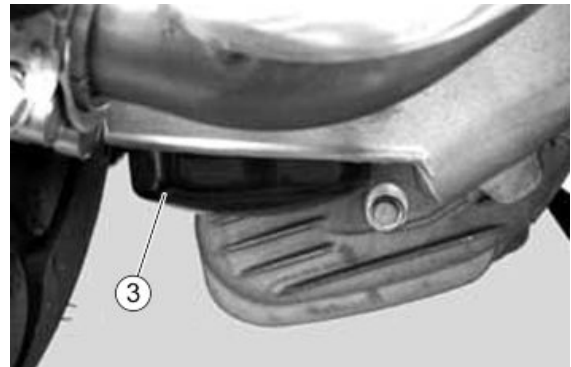

- Refit a new cartridge filter making sure to lubricate the O-ring before fitting, then screw until it comes into contact with the gasket and further tighten to the prescribed torque.
- Fill with recommended engine oil (refer to the Recommended Products table) and to prescribed amount (refer to «Engine oil change» section).
- Start the engine and let it run for a few minutes and then shut it off.

After five minutes check the level and, if necessary, top up **without exceeding the MAX level**.

Locking torques (N*m)

Engine oil drainage plug 24 ÷ 30 Engine oil filter 12 ÷ 16

Cooling system

Level check

CAUTION



WAIT FOR THE ENGINE TO COOL DOWN BEFORE CHECKING OR TOPPING-UP COOLANT LEVEL.

- Shut off the engine and wait until it cools off.

CAUTION



PARK THE VEHICLE ON SAFE AND LEVEL GROUND.

- Remove the front central cover.
- Loosen (by turning it clockwise) but do not remove the filler cap «1».
- Wait for some seconds so that any pressure could be purged.
- Unscrew and remove the cap «1».

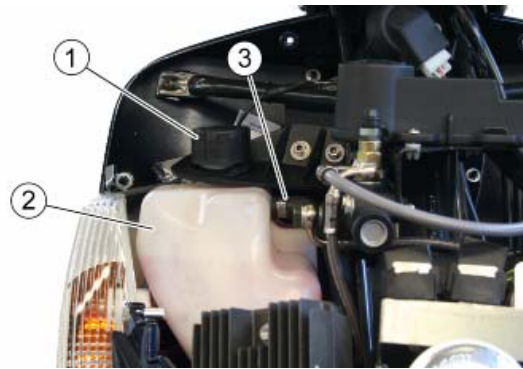

- Make sure that the coolant level in the expansion tank «2» is between the «MIN» and «MAX» reference marks.

MIN = minimum level.

MAX = maximum level.

- Top-up if necessary.

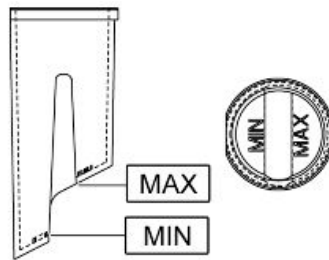
**Top-up****CAUTION****WAIT FOR THE ENGINE TO COOL DOWN BEFORE CHECKING OR TOPPING-UP COOLANT LEVEL.**

- Loosen but do not remove the filler cap «1» (by rotating it anticlockwise).
- Wait for a few seconds so that any pressure could be purged.
- Unscrew and remove the cap «1».

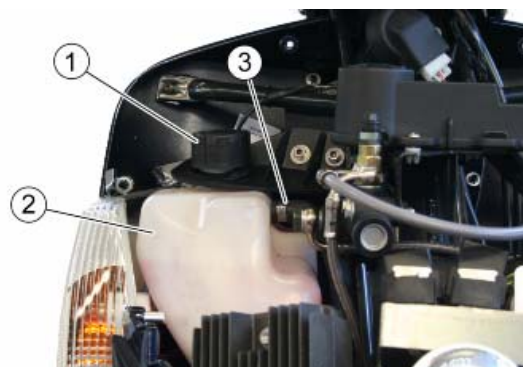
**CAUTION****DO NOT ADD ADDITIVES OR ANY OTHER SUBSTANCE TO THE COOLANT.**

- Top-up with coolant until the fluid level is near the «MAX» reference mark.

CAUTION



WHEN TOPPING-UP, DO NOT EXCEED THE «MAX» LEVEL OR THE FLUID WILL FLOW OUT WHEN THE ENGINE IS RUNNING.

- Refit the filler cap «1».
- Refit the central cover.

CAUTION

IF THERE IS AN EXCESSIVE CONSUMPTION OF COOLANT OR WHEN THE EXPANSION TANK IS EMPTY, CHECK THAT THERE ARE NO LEAKS IN THE CIRCUIT.

Recommended products

AGIP PERMANENT SPEZIAL Coolant

Biodegradable coolant, ready for use, with "long life" technology and characteristics (pink). Freezing protection up to -40°C. According to CUNA 956-16 standard.

Braking system

CAUTION



CONSIDERING THE DANGER FOR VEHICLE AND RIDER, IT IS STRICTLY NECESSARY, AFTER REFITTING BRAKES AND RESTORING THE BRAKING SYSTEM TO THE REGULAR USE CONDITIONS, THAT THE HYDRAULIC CIRCUIT BE AIR PURGED.

NOTE

THIS VEHICLE IS FITTED WITH A BRAKING SYSTEM COMPRISING:

- TWO BRAKE DISCS ON THE FRONT WHEEL.
- A BRAKE DISC ON THE REAR WHEEL.
- A DISTRIBUTION VALVE LOCATED IN THE LEGSHIELD.

Operating the right (front) brake lever exerts pressure on the front right brake calliper.

Operating the left (rear) brake lever, through the distribution valve, exerts pressure on the front left and rear brake callipers.

Level check

CAUTION



PARK THE VEHICLE ON SAFE AND LEVEL GROUND.

To check level:

- Rest the vehicle on its centre stand.
- Turn the handlebar so that the fluid in the brake fluid reservoir is parallel to the «MIN» reference mark indicated on the sight glass «1».
- Check that the level in the reservoir is over the reference «MIN» indicated on the sight glass «1».



«MIN » = Minimum level.

CAUTION



DO NOT USE YOUR VEHICLE IF THE FLUID DOES NOT REACH AT LEAST AT THE «MIN» REFERENCE MARK.

If the fluid does not reach at least the «MIN» reference mark:

- Check the brake pads and discs for wear. If the pads and/or the disc do not need replacing, top-up the fluid.

NOTE

FLUID LEVEL GOES DOWN GRADUALLY AS THE PADS WEAR OUT.

Top-up

- The operations are described only once, but they are valid for both brake pumps.
- Remove the rear-view mirror.
- Undo screw «1».



- Undo the two screws «2» and the shorter screw «3».

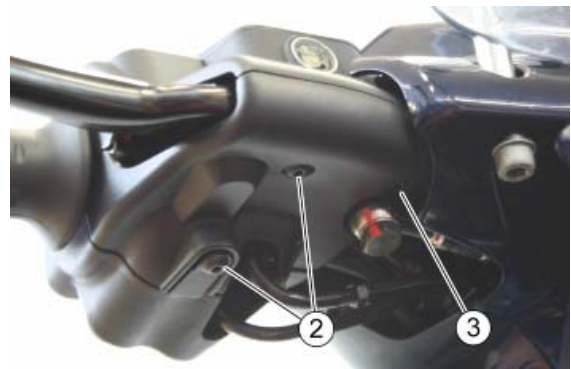

- To remove the lower and upper pump covers release them from their retainers.



- Undo the 4 screws «4».

CAUTION



**RISK OF BRAKE FLUID SPILLS.
DO NOT PULL THE BRAKE LEVER WHEN THE SCREWS ARE LOOSE OR, MAINLY, WHEN THE BRAKE FLUID RESERVOIR COVER HAS BEEN REMOVED.
PLACE A CLOTH UNDER THE BRAKE FLUID RESERVOIR TO PROTECT IT FROM ANY FLUID SPLASHES.**

CAUTION



**TOP-UP TO MAXIMUM LEVEL MARK ONLY WHEN BRAKE PADS ARE NEW. BRAKE FLUID LEVEL DECREASES GRADUALLY AS BRAKE PADS WEAR OUT.
WHEN TOPPING-UP, DO NOT EXCEED THE MAXIMUM LEVEL MARK WHEN BRAKE PADS ARE WORN AS YOU RISK SPILLING FLUID WHEN CHANGING THE BRAKE PADS.**



- Remove the pump cover with its gasket and top-up the reservoir only with recommended fluid.

Recommended products

AGIP BRAKE 4 Brake fluid

FMVSS DOT 4 Synthetic fluid



System check

To carry out a quick pad check:

- Rest the vehicle on its centre stand.
- Visually check the brake disc and pads, as indicated below.

Front brake callipers

From the front bottom side for both pads.

Repeat the operation for the other calliper.



Rear brake calliper

From the back bottom side for both pads «1».

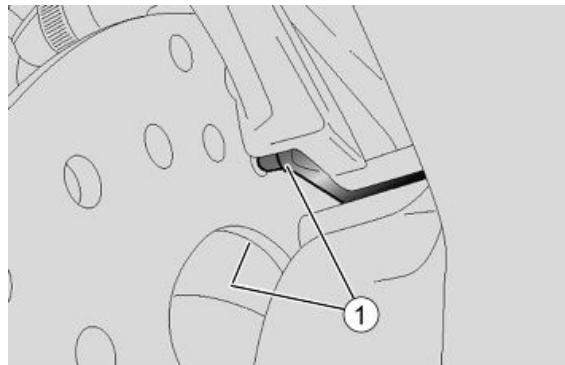

- Replace both pads if the friction material thickness (even in only one pad) is reduced to about 1.5 mm.

Front pads «2».

Rear pads «3».

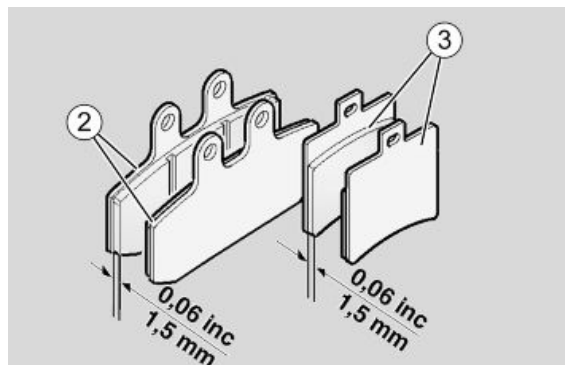

- In case of uneven wear, replace the pads when there is a thickness difference of 0.5 mm in the friction material.

CAUTION



ALWAYS REPLACE BOTH PADS AND MAKE SURE THEY ARE CORRECTLY POSITIONED INSIDE THE CALLIPER.

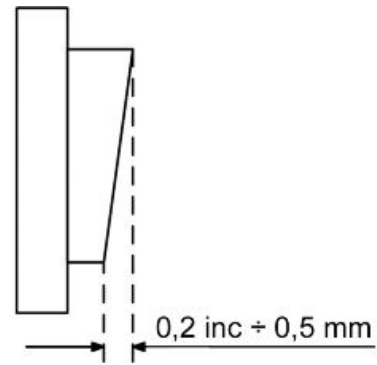

Dashboard

Turning the ignition key to "ON" activates all the segments on the multifunction LCD (this checks component correct operation) and displays the last function set after switching off the engine.

NOTE

THE SERVICE ICON IS DISPLAYED ON THE LCD AFTER RIDING THE FIRST 1000 km (621 mi) AND THEN AFTER EVERY 10000 km (6214 mi). THE SERVICE ICON FLASHES FOR ABOUT 5 SECONDS AFTER THE IGNITION CHECK, 300 KM (186 mi) TO THE NEXT SERVICE. ONCE THE MILEAGE FOR A SERVICE HAS BEEN REACHED, THE ICON WILL BE STEADILY ON UNTIL THE SERVICE IS CARRIED OUT.

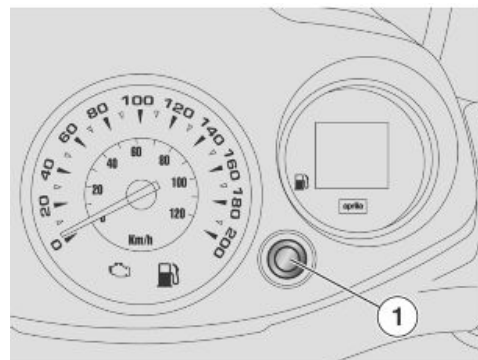

Several functions can be selected and viewed on the display using the (MODE) button «1» on the controls on the left hand side of the handlebar. The segments of the multifunction LCD display are the following:

- digital clock «3»,
- odometer indicator «4»,
- unit of measurement in km «5»,
- icon showing unit of measurement in miles «6»,
- trip odometer indicator «7»,
- scheduled maintenance service indicator «8»,
- fuel gauge «9».

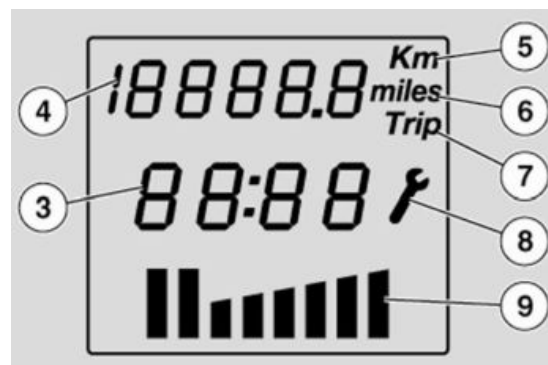

The function sequence is summarised in the next diagram:

Pulse means each time the key is pressed for between 0.5 and 3 seconds.

Initial Status

When switched on, the instrument panel shows the last function selected.

DIGITAL ODOMETER

These are the segments of the digital odometer functions on the LCD display:

Icon to display trip odometer, six digits «4», icon showing unit of measure in km «5», icon showing unit of measure in miles «6».

Pressing the MODE button «2» displays in sequence the modes:

- Trip odometer
- TRIP
- Battery voltage

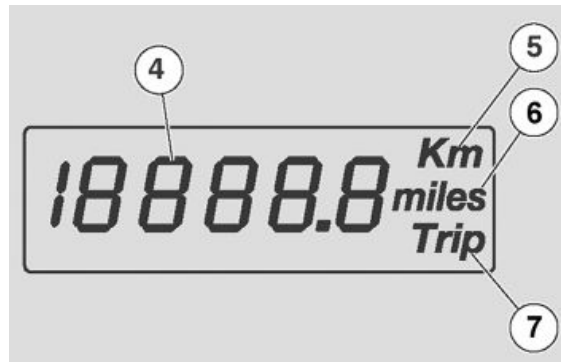

Resetting the trip odometer

When in the trip odometer function, press and hold the MODE button «1» longer than 3 seconds to reset this function.

NOTE

THE DISPLAYED FUNCTION IS RESET.

DIGITAL ODOMETER

These are the segments of the digital odometer functions on the LCD display:

- Trip odometer icon «5».
- 6-digit display «2».
- Unit of measurement in km icon «3».
- Unit of measurement in mi icon «4».

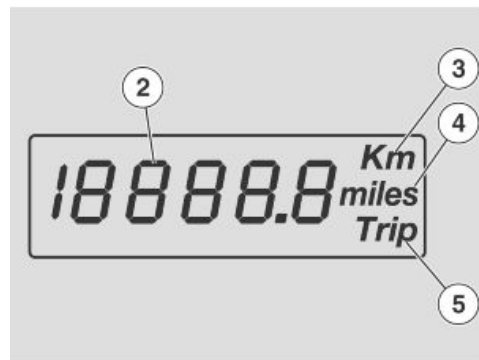

Pressing the MODE button «1» displays the modes in sequence:

- Trip odometer.
- Trip.
- Battery voltage.

The warning lights should be visible even under direct sunlight.

Turn indicators

This warning light has a green LED that turns on concurrently with the turn indicators.

Fuel reserve

This warning light has a yellow/amber LED that turns on when the vehicle has low fuel.

Oil alarm

This warning light has a red LED and signals that oil pressure is wrong.

High-beam lights

This warning light has a blue LED and must be on when the high-beam light is activated.

EFI

This warning light has a red LED and signals there is an engine control unit failure.

External antitheft device

This warning light has a red LED and it is controlled by an external antitheft device (it is therefore not managed by the microprocessor).

Clock adjustment

When the TRIP function is displayed, press and hold down the MODE button «1» for more than 3 seconds to access the clock adjustment mode; The colon dividing hours-minutes starts flashing.

The first adjustment to be made is the hours. The value displayed increases each time the MODE button «1» is pressed.

Press the MODE button again «1» for more than 3 seconds to access the minute adjustment mode.

The value displayed increases each time the MODE button «1» is pressed.

Press the MODE button «1» for more than 3 seconds to access the hour adjustment mode.

If no button is pressed within three seconds, the display automatically exits the clock adjustment function and goes back to the function it displayed before the clock adjustment mode was accessed.

NOTE

THE CLOCK CAN BE SET ONLY WHEN THE ENGINE IS OFF OR THE VEHICLE IS AT A STAND-STILL AND WITH OR WITHOUT THE ENGINE RUNNING.

Km or miles selection

When the battery function is displayed, press and hold down the MODE button «1» for more than 10 seconds to shift from km to miles reading or vice versa for either the odometer or the speedometer (if it is on the display).

While the button is held down, the legend of the unit of measurement (Km or Miles) currently in use must flash at a frequency of 1Hz.

If the button is released before 10 seconds elapse, the unit of measurement does not vary.

Other functions:

Software version

The software version is displayed when the battery is activated.

SERVICE

The Service icon is displayed after riding the first 1000 km and then after every 10,000 km. The Service icon flashes for about 5 seconds after the

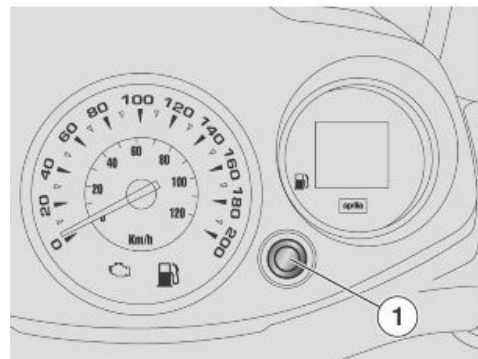

ignition check, 300 km to the next service. Once the mileage for the service has been reached, the icon will be steadily on until the Service is reset.

Reset service

To reset the service, press and hold down the MODE button «1» for 10 seconds when inserting the key. There will be no instrument panel indication for the first 5 seconds but the next 5 seconds the service icon will flash at a frequency of 1 Hz.

Headlight adjustment

For a quick check of the correct direction of the front light beams, place the vehicle ten metres from a vertical wall and make sure the ground is level.

Turn on the low beam light, sit on the vehicle and check that the light beam projected to the wall is a little below the headlight horizontal straight line (about 9/10 of the total height).

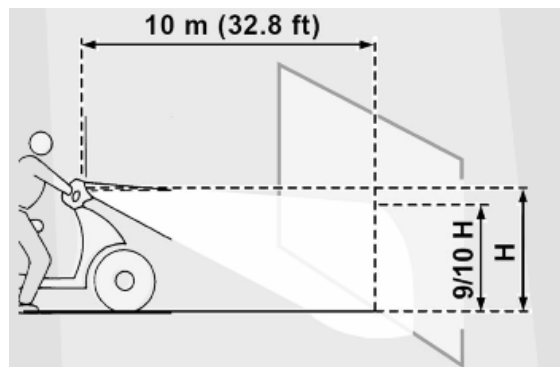

To adjust the light beam:

- Unscrew and remove the headlight lower screw «1».
- Remove the chromium-plated ring nut.
- Move the headlight upper lock slightly forward but do not remove it.
- Insert a screwdriver in the front headlight set screw «2».

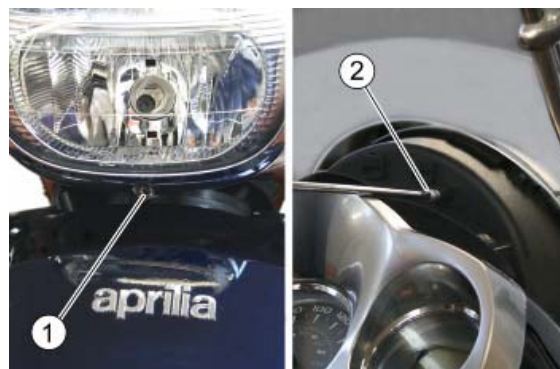

- Turn it CLOCKWISE to lower the light beam.
- Turn it ANTICLOCKWISE to raise the light beam.

INDEX OF TOPICS

ELECTRICAL SYSTEM

ELE SYS

Components arrangement

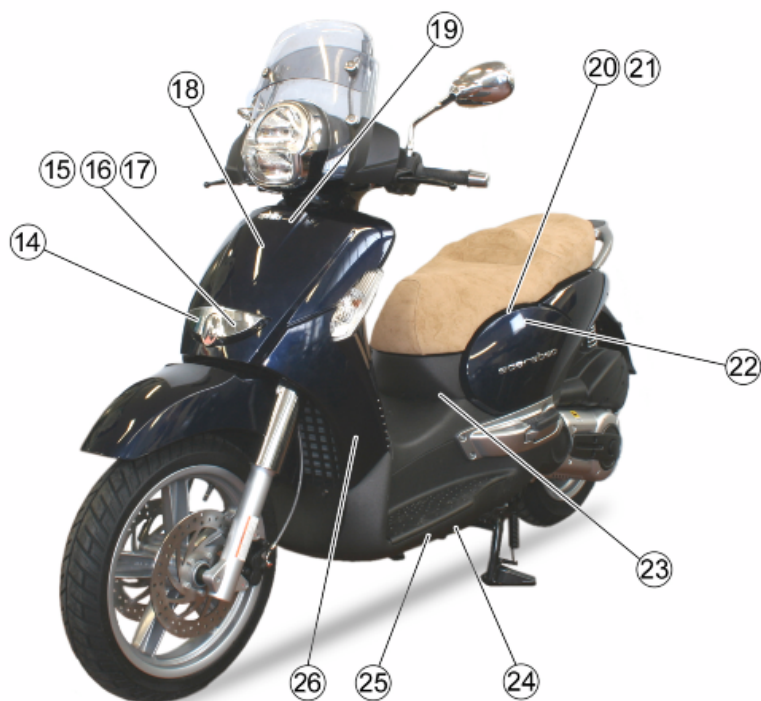
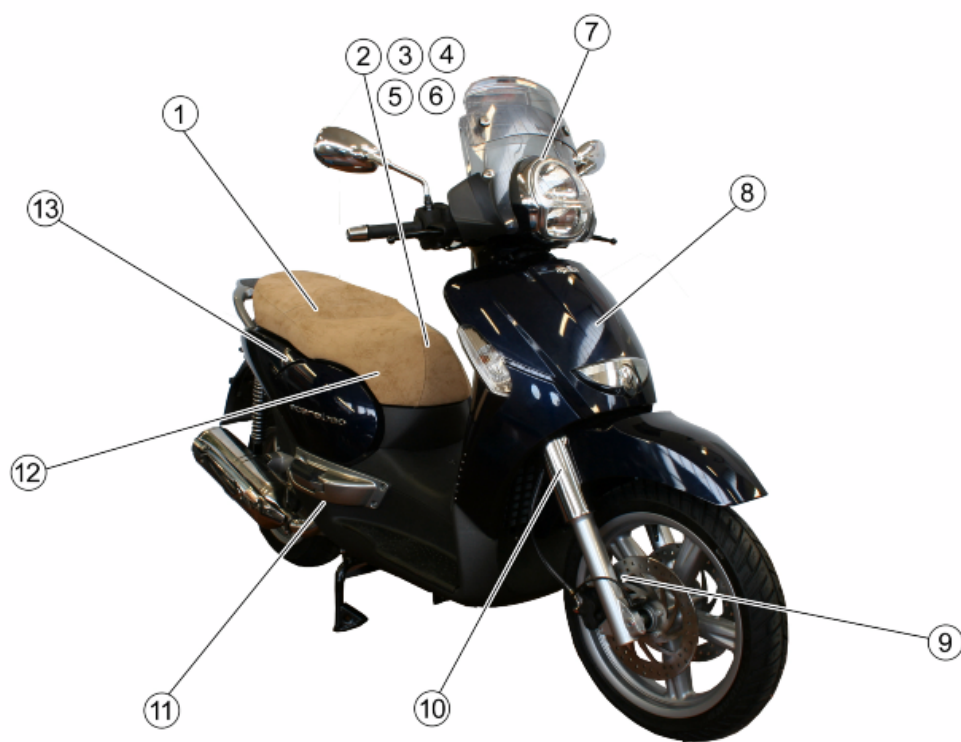

1. INJECTION ELECTRONIC CONTROL UNIT

Location: on the throttle body. Remove the helmet compartment to reach it.

Connector location: on the component.



2. MAIN FUSES

Location: under the specific battery cover placed in the helmet compartment.



3. AUXILIARY FUSES

Location: under the specific battery cover placed in the helmet compartment.



4. BATTERY

Location: under the specific battery cover placed in the helmet compartment.



5. DIAGNOSTICS SOCKET

Location: under the battery cover placed in the helmet compartment.

**6. INSTRUMENT PANEL DIAGNOSTICS SOCKET**

Location: under the battery cover placed in the helmet compartment.

**7. INSTRUMENT PANEL**

Connector location: on the component.

**8. PLUG SOCKET**

Location: inside the front glove-box.

Connector location: on the component.



9. SPEED SENSOR

Location: on the front wheel right side.

Connector location: under the legshield, near the horn.



10. FAN

Location: at the front part of the vehicle, on the radiator. Remove the shield back plate to reach it.

Connector location: under the central cover, near the fuel level sensor.



11. OIL SENSOR

Location: on the engine, on the vehicle right fairing.

Connector location: on the component.

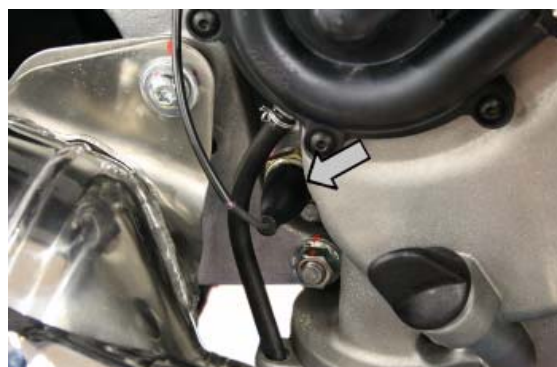

12. START-UP RELAY

Location: on the vehicle right fairing, fixed to the helmet compartment. Remove the tail section to reach it.

Connector location: on the component.



13. STARTER MOTOR

Connector location: on the engine, near the throttle body.

**14. VOLTAGE REGULATOR**

Location: at the front part of the vehicle, near the component supporting plate. Remove the leg-shield to reach it.

Connector location: under the central cover, near the fuel pump.

**15. HORN**

Location: at the front part of the vehicle, near the component supporting plate. Remove the leg-shield to reach it.

Connector location: on the component.

**16. RELAY**

Location: at the front part of the vehicle, on the component supporting plate. Remove the leg-shield to reach it.

Connector location: on the corresponding relays.

A. Start-up logic relay and key relay.

B. Injection relay and fan relay.

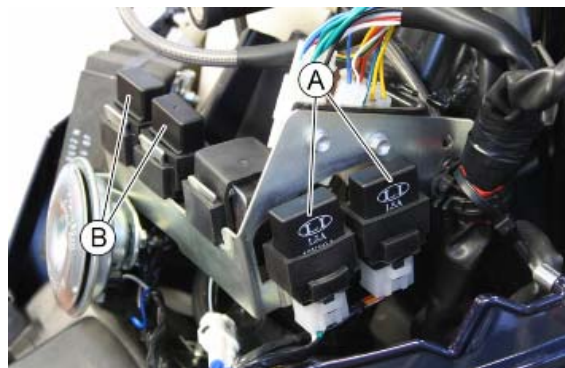
**WARNING**

TO IDENTIFY THE RELAY REFER TO THE CABLE COLOUR INDICATED ON THE WIRING DIAGRAM.

17. FALL SENSOR

Location: at the front part of the vehicle, on the component supporting plate. Remove the leg-shield to reach it.

Connector location: near the component.



18. ANTITHEFT CONTROL UNIT

Location: at the front part of the vehicle, near the key switch. Remove the legshield to reach it.

Connector location: on the component.



19. KEY SWITCH

Location: at the front part of the vehicle. Remove the legshield to reach it.

Connector location: on the component.



20. GENERATOR

Connector location: under the central cover, near the fuel pump.



21. PICK-UP

Connector location: under the central cover, near the fuel pump.

**22. GLOVE-BOX ELECTRIC LOCK**

Location: on the vehicle left fairing, fixed to the helmet compartment. Remove the tail section to reach it.

Connector location: on the component.

**23. SPARK PLUGS**

Location: at the front part of the engine. Remove the central inspection cover to reach them.

**24. SIDE STAND SWITCH**

Location: at the bottom on the vehicle left fairing. Remove the left footrest to reach it.

Connector location: under the central cover, near the fuel pump.



25. HV COIL

Location: at the bottom on the vehicle left fairing, near the side stand. Remove the left footrest to reach it.

Connector location: on the component.



26. FUEL LEVEL SENSOR

Location: on the fuel tank. Remove the central cover to reach it.

Connector location: on the component.



Ground points

Ground point on the engine

Placed on the vehicle right side next to the swinging arm support bearing. Remove the tail section to reach it.



Ground point on the chassis

Placed on the vehicle right side. Remove the tail section to reach it.



Electrical system installation

Front side

MAIN CABLE HARNESS FITTING



KEY

1. 180x4.5 Clamp
2. 290x4.5 Clamp
3. 290x4.5 Clamp (holds the Main Cable Harness and Flywheel cables).
4. Attach the chassis retainer (already on the cable harness).
5. 290x4.5 Clamp

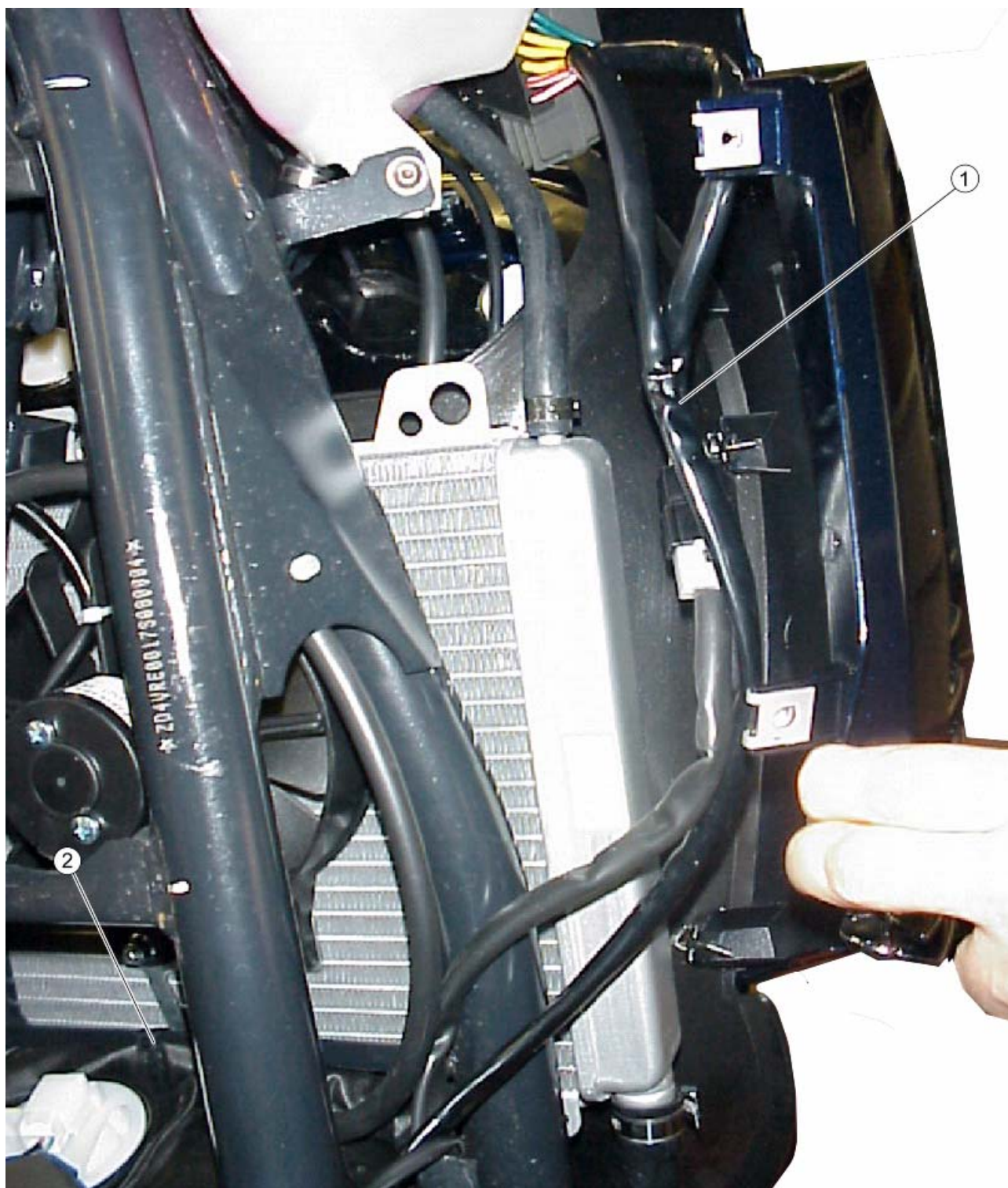
**KEY**

1. Do not use any clamps
2. 290x4.5 Clamp

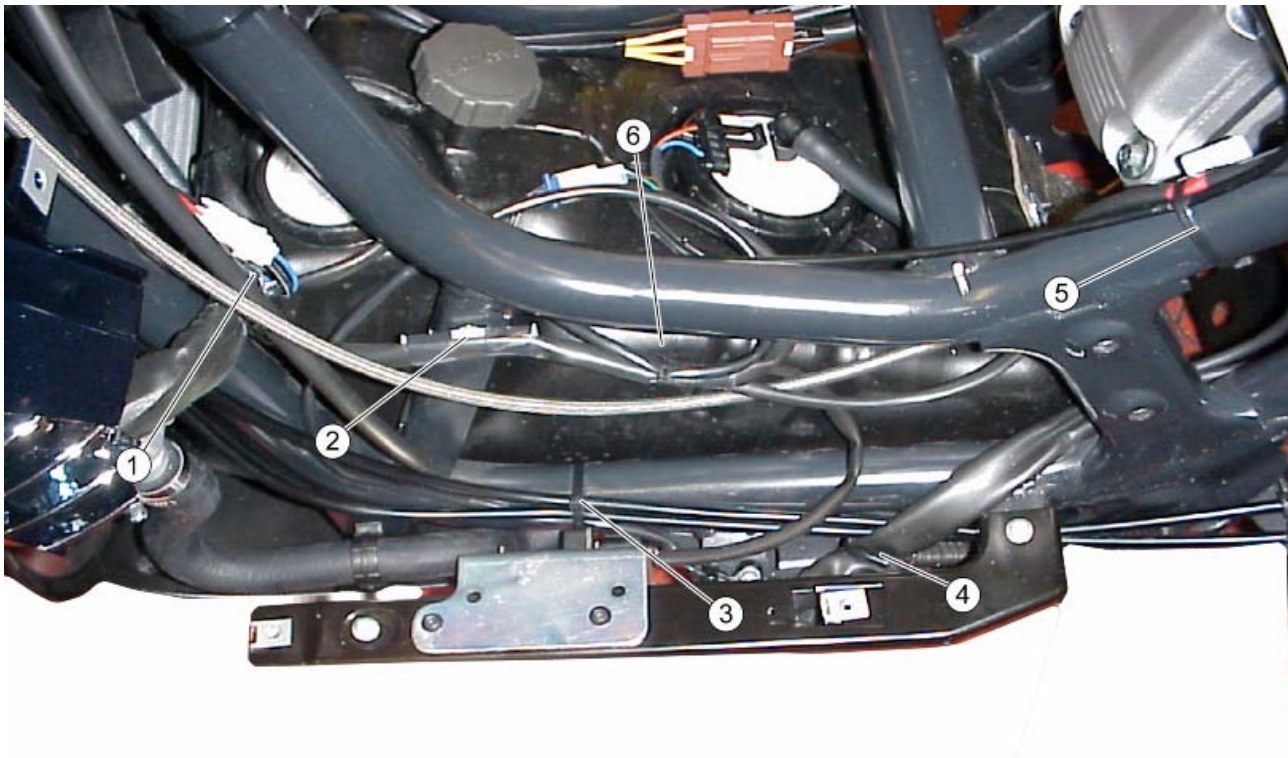
**KEY**

1. 290x4.5 Clamp
2. Attach the chassis retainer (already on the cable harness).
3. 290x4.5 Clamp
4. 290x4.5 Clamp
5. 290x4.5 Clamp (do not pull with force).
6. 98x2.5 Clamp

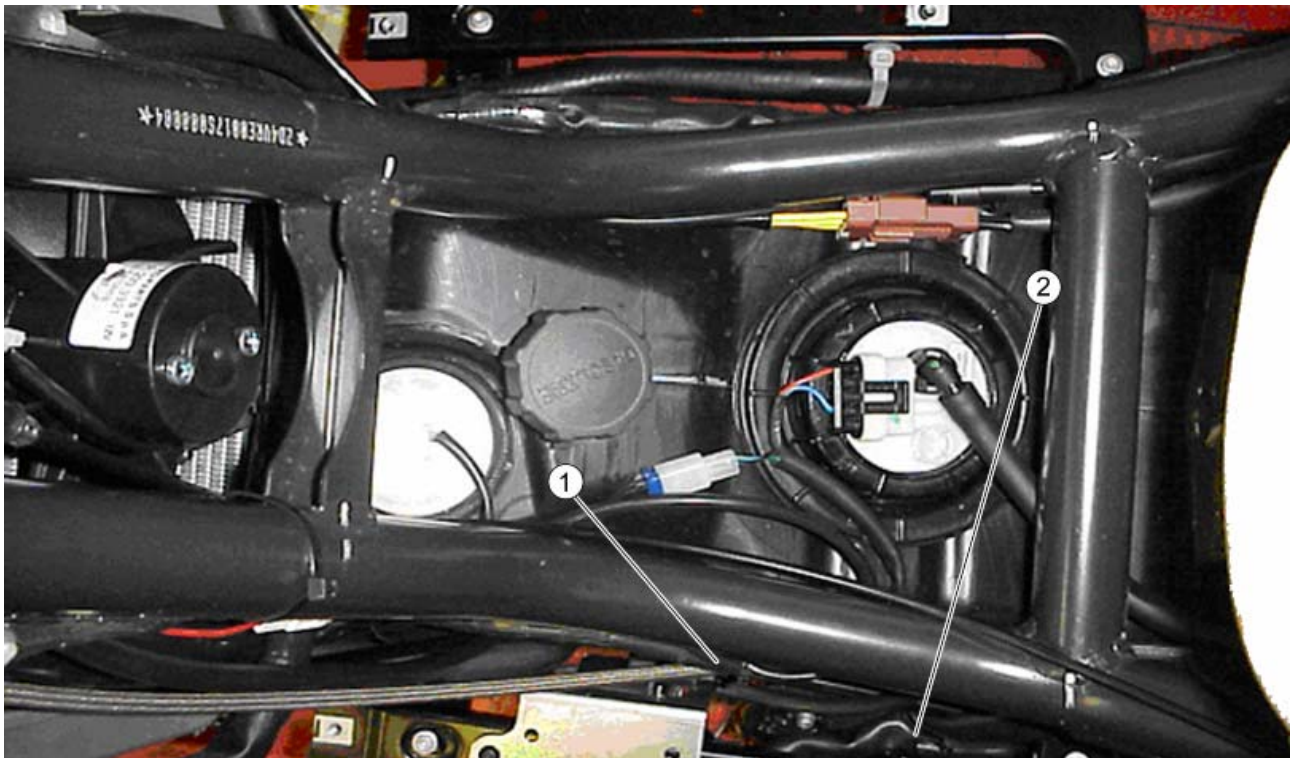

KEY

- 1. 98x2.5 Clamp
- 2. 290x4.5 Clamp

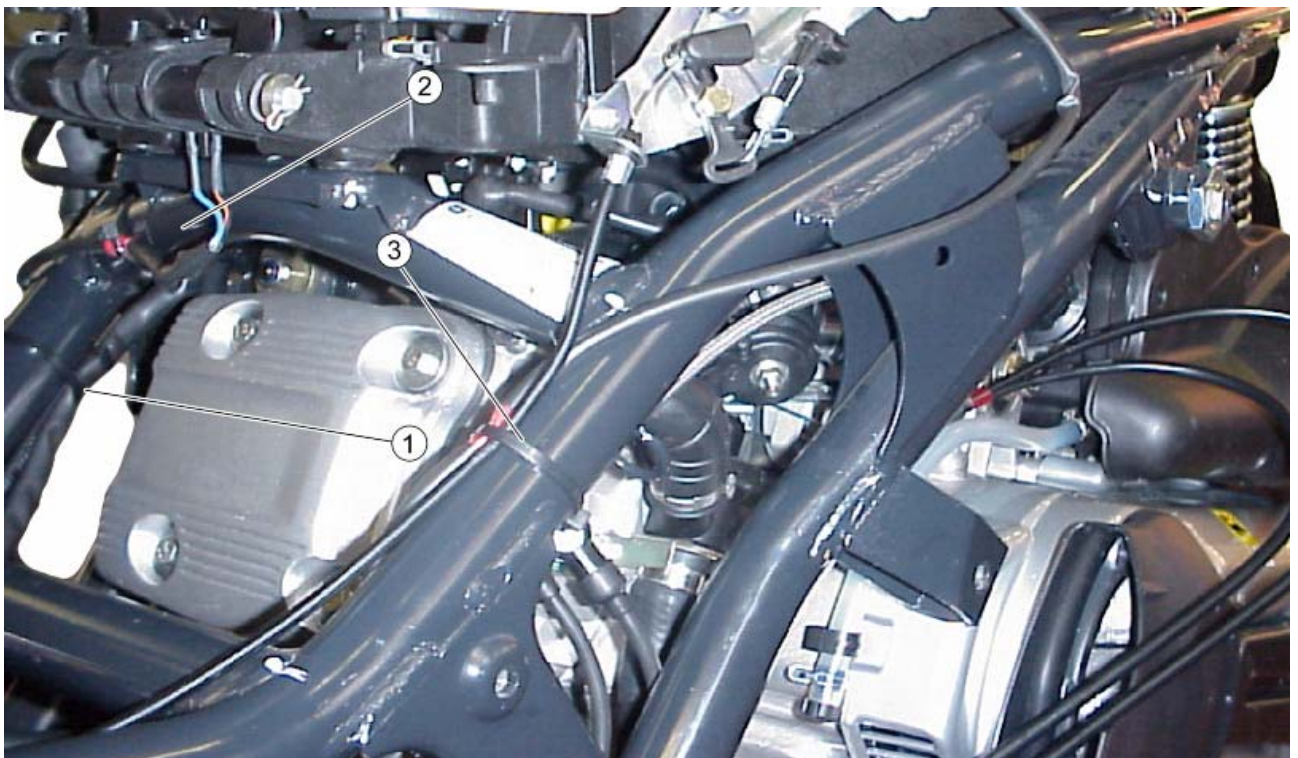

KEY

- 1. 290x4.5 Clamp (holds the Main Cable Harness and Flywheel cables).

2. 180x4.5 Clamp
3. 290x4.5 Clamp (do not pull with force).

**KEY**

1. Cable guide plus a clamp
2. 290x4.5 Clamp

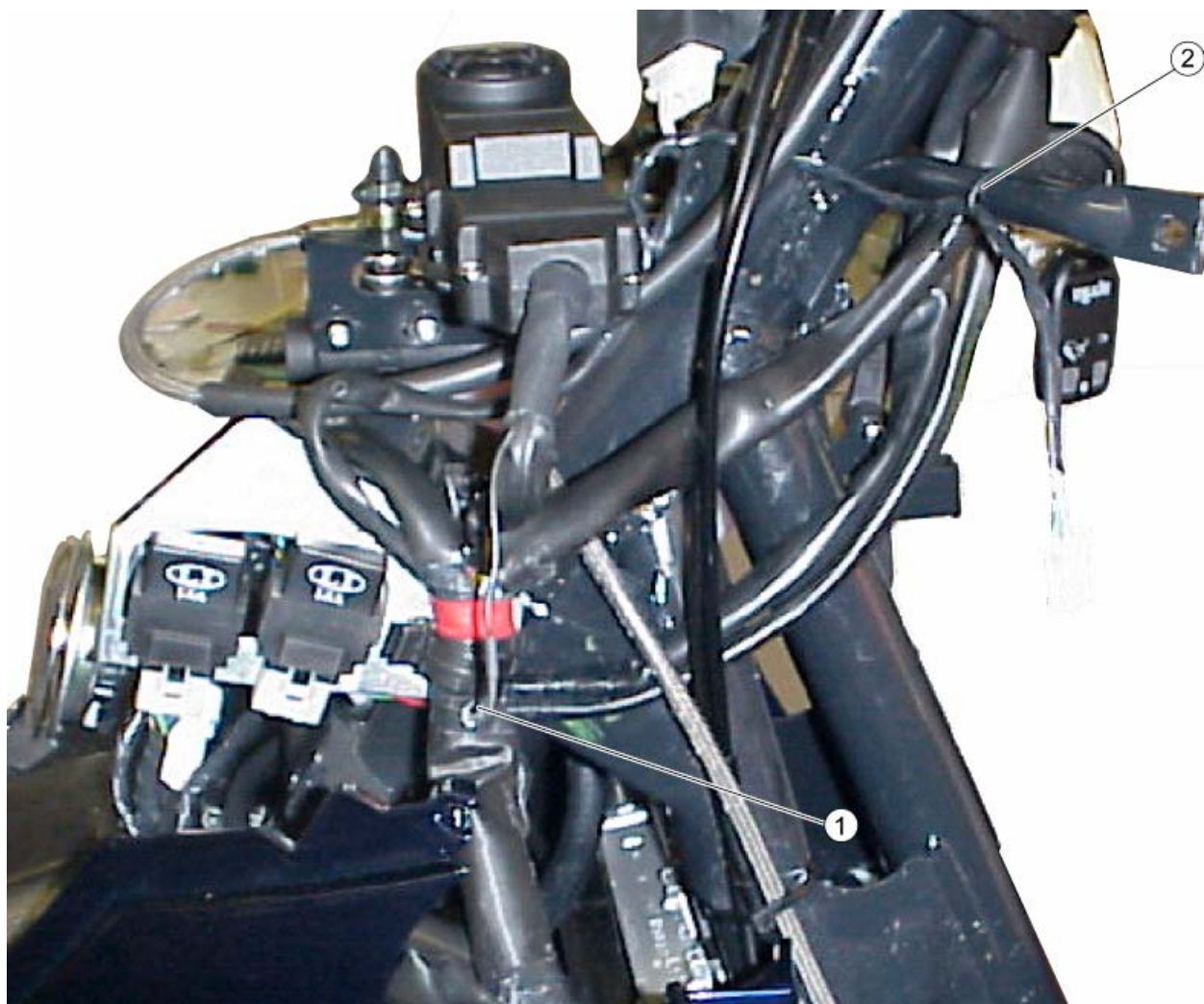
**KEY**

- 1. Cable guide plus a clamp
- 2. 98x2.5 Clamp

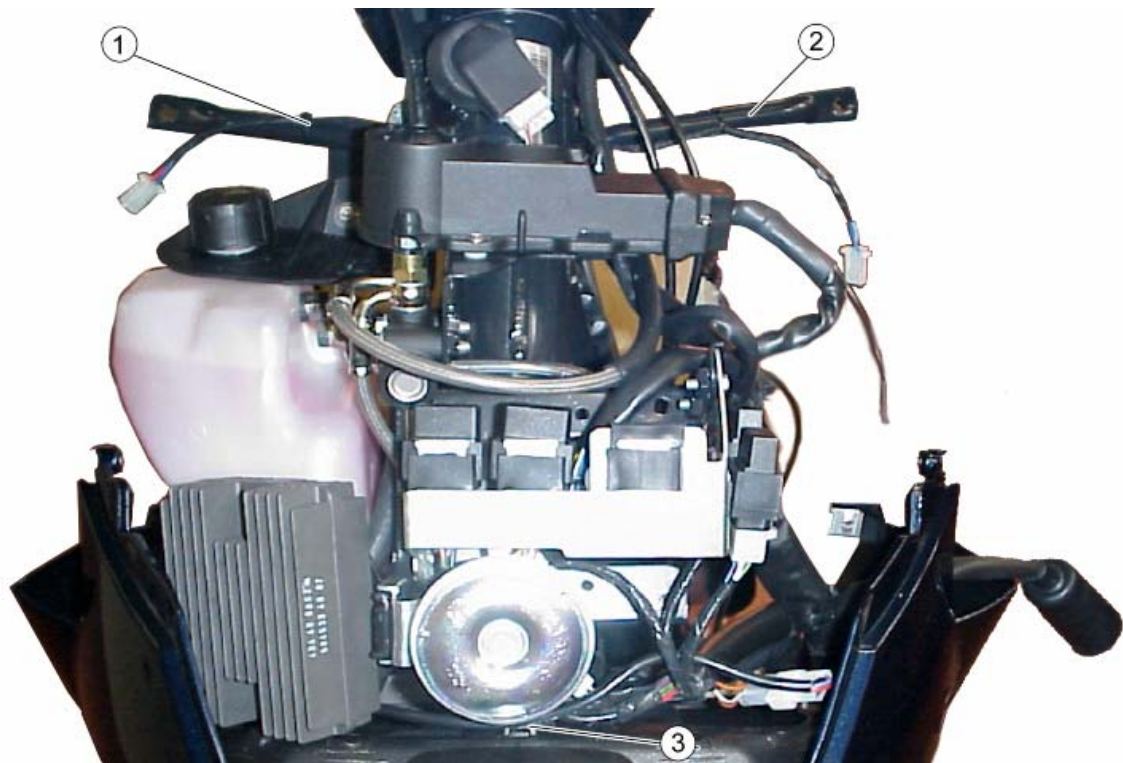

KEY

- 1. 98x2.5 Clamp
- 2. 98x2.5 Clamp
- 3. 98x2.5 Clamp



KEY

1. Start-up relay fitted on the rubber ring
2. Cable guide plus a clamp
3. 98x2.5 Clamp

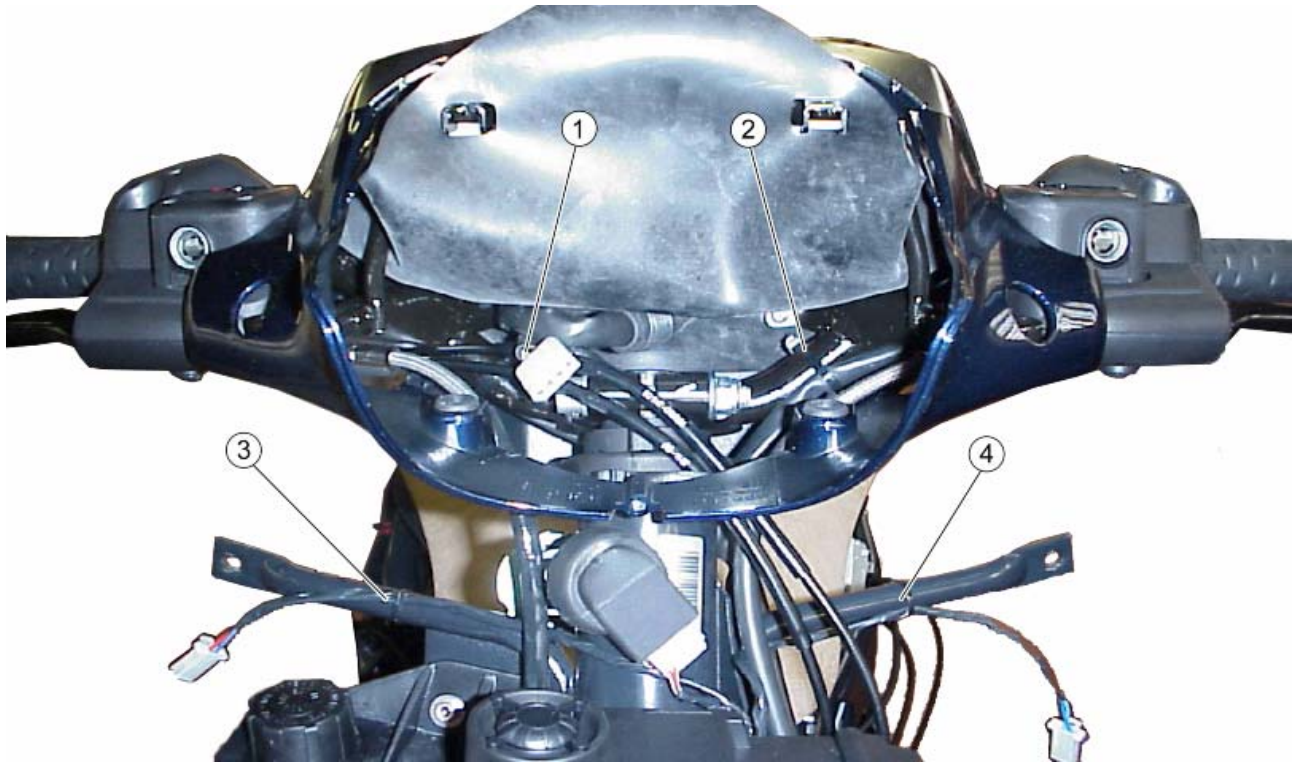
**KEY**

1. 180x4.5 Clamp
2. 180x4.5 Clamp
3. 98x2.5 Clamp
4. 98x2.5 Clamp

RIGHT LIGHT SWITCH

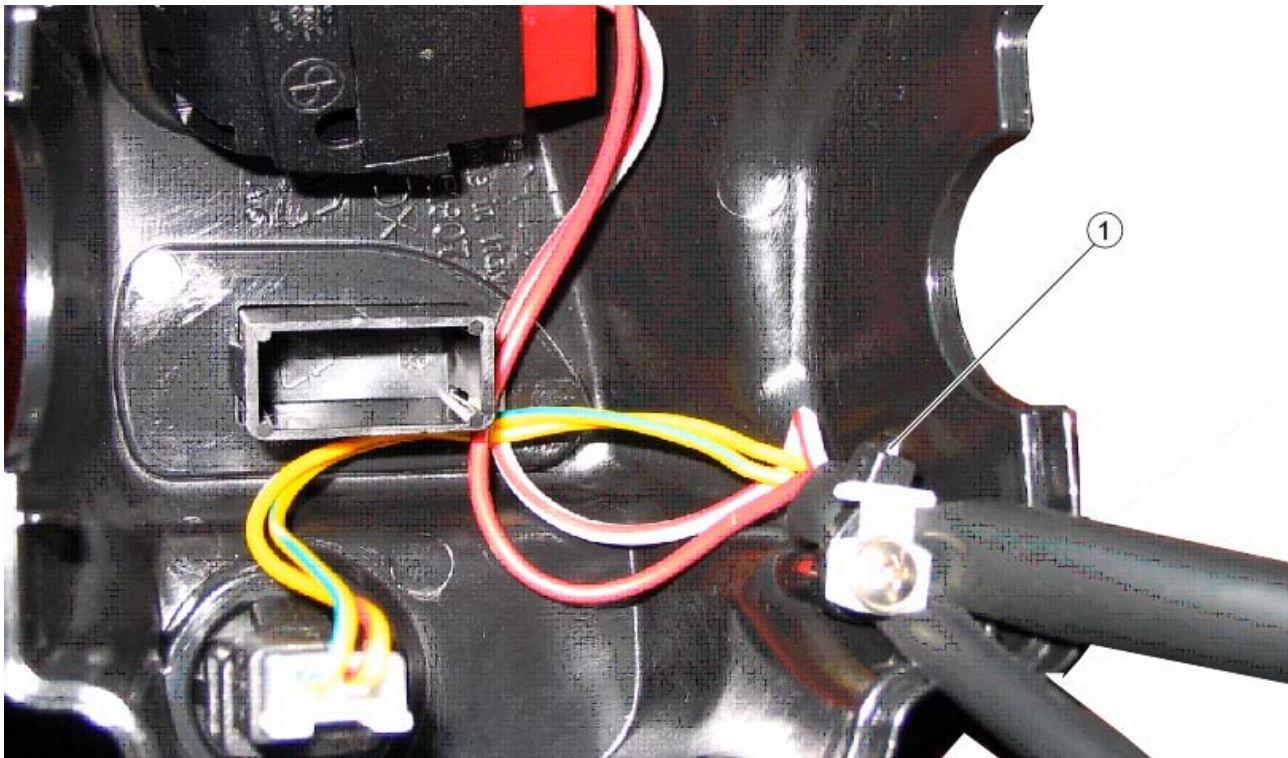

KEY

1. 98x2.5 Clamp

LEFT LIGHT SWITCH

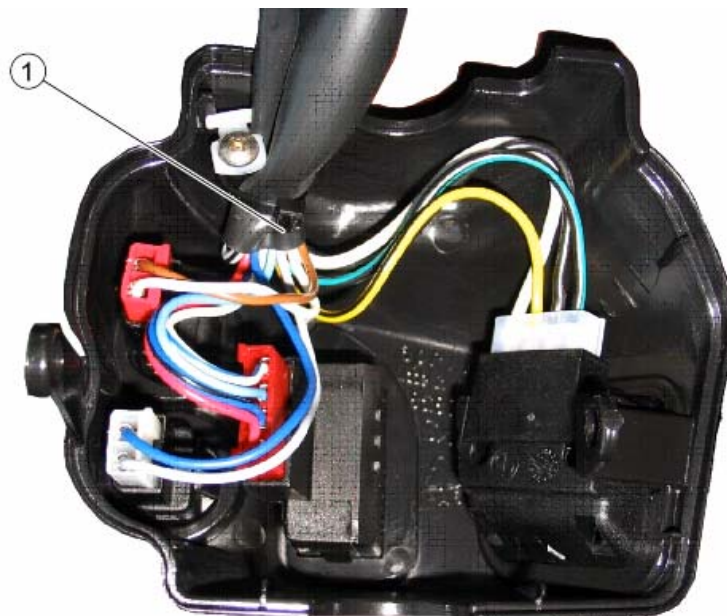

KEY

1. 98x2.5 Clamp



SPEED SENSOR FITTING



KEY

- 1. 98x2.5 Clamp
- 2. 98x2.5 Clamp
- 3. 98x2.5 Clamp

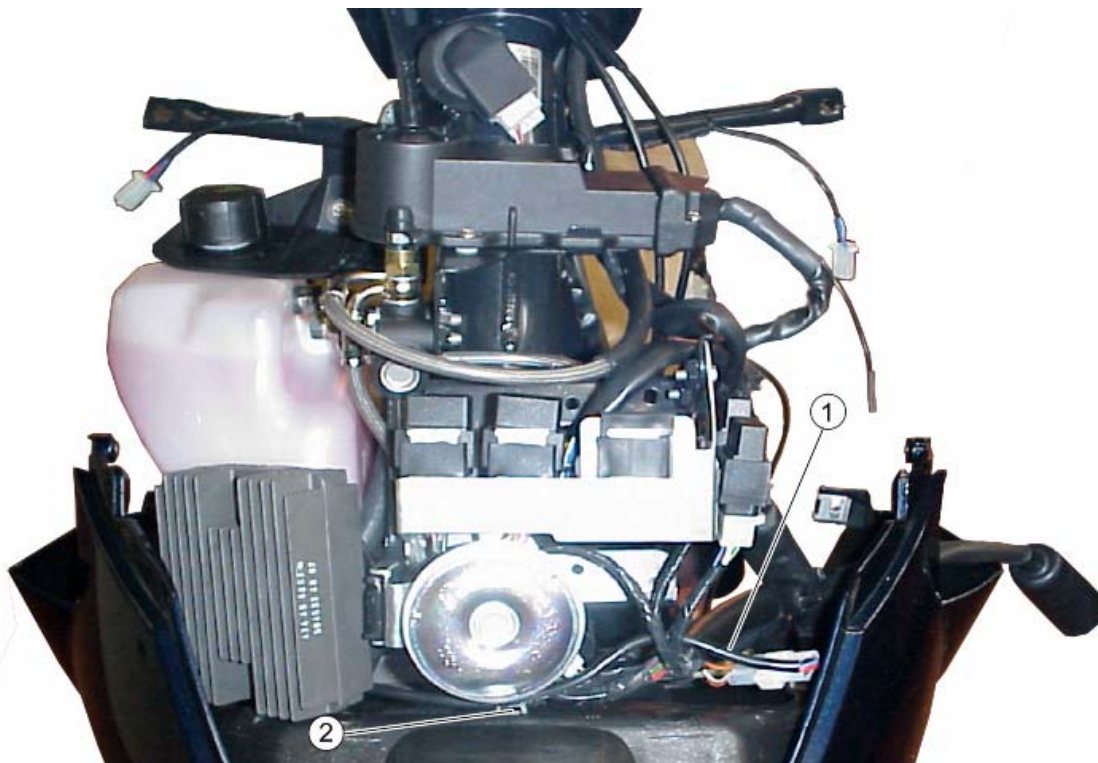

KEY

- 1. Speed Sensor Connection
- 2. 98x2.5 Clamp

Back side

MAIN CABLE HARNESS FITTING

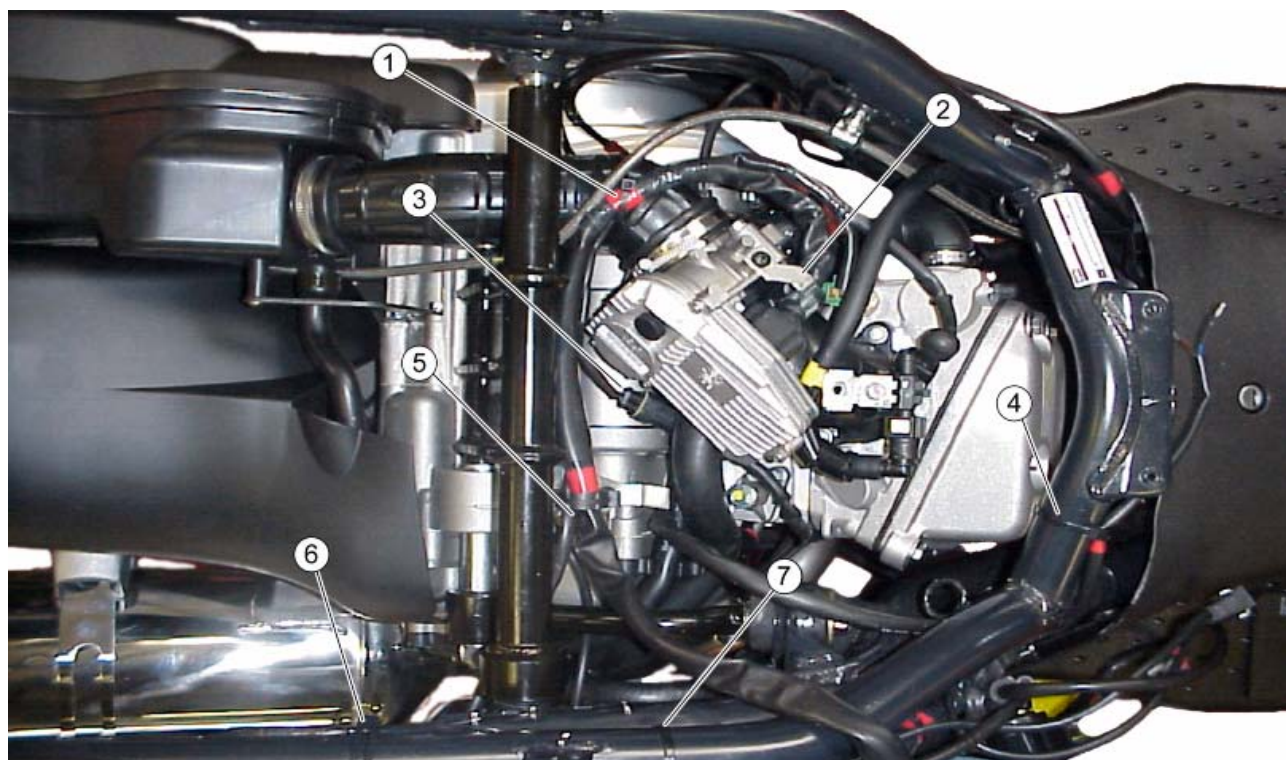
**KEY:**

1. 290 x 4.5 Clamp
2. Metal clamp
3. LAMBDA Probe connector
4. 180 x 4.5 Clamp
5. Cable guide
6. The cable harness must be under the cable guide
7. 290 x 4.5 Clamp

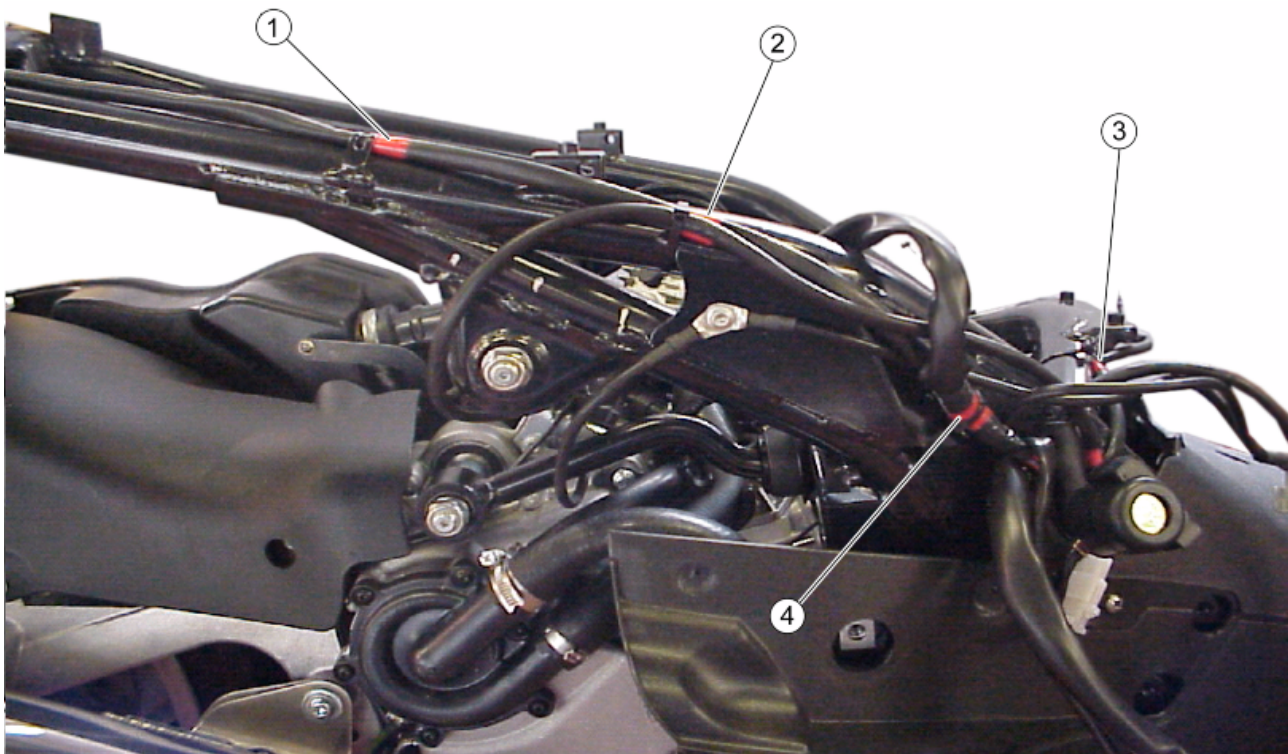

KEY:

1. The cable harness must be under the cable guide
2. 290 x 4.5 Clamp
3. 180 x 4.5 Clamp
4. 290 x 4.5 Clamp



KEY:

1. 290 x 4.5 Clamp
2. Cable guide
3. Metal bracket
4. The cable harness must be under the cable guide
5. 290 x 4.5 Clamp

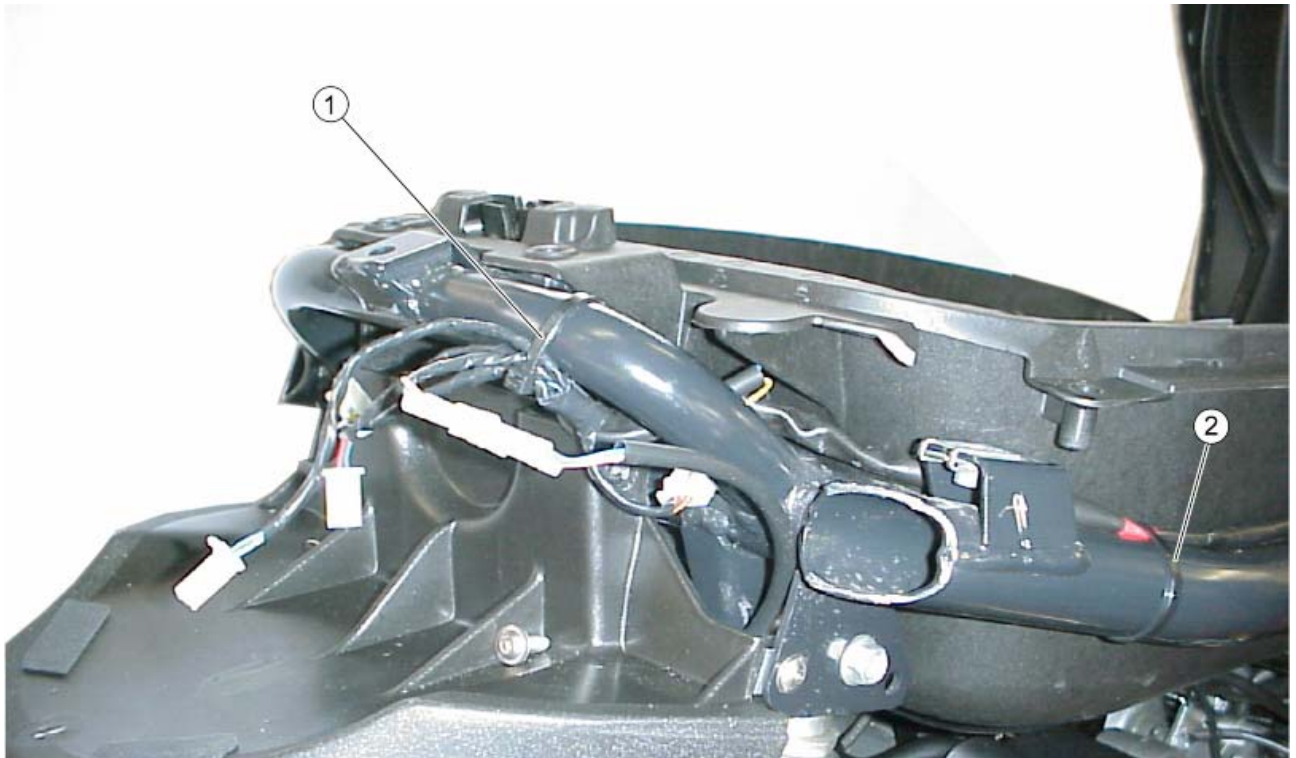
**KEY:**

1. 180 x 4.5 Clamp
2. 290 x 4.5 Clamp



KEY:

- 1. 180 x 4.5 Clamp

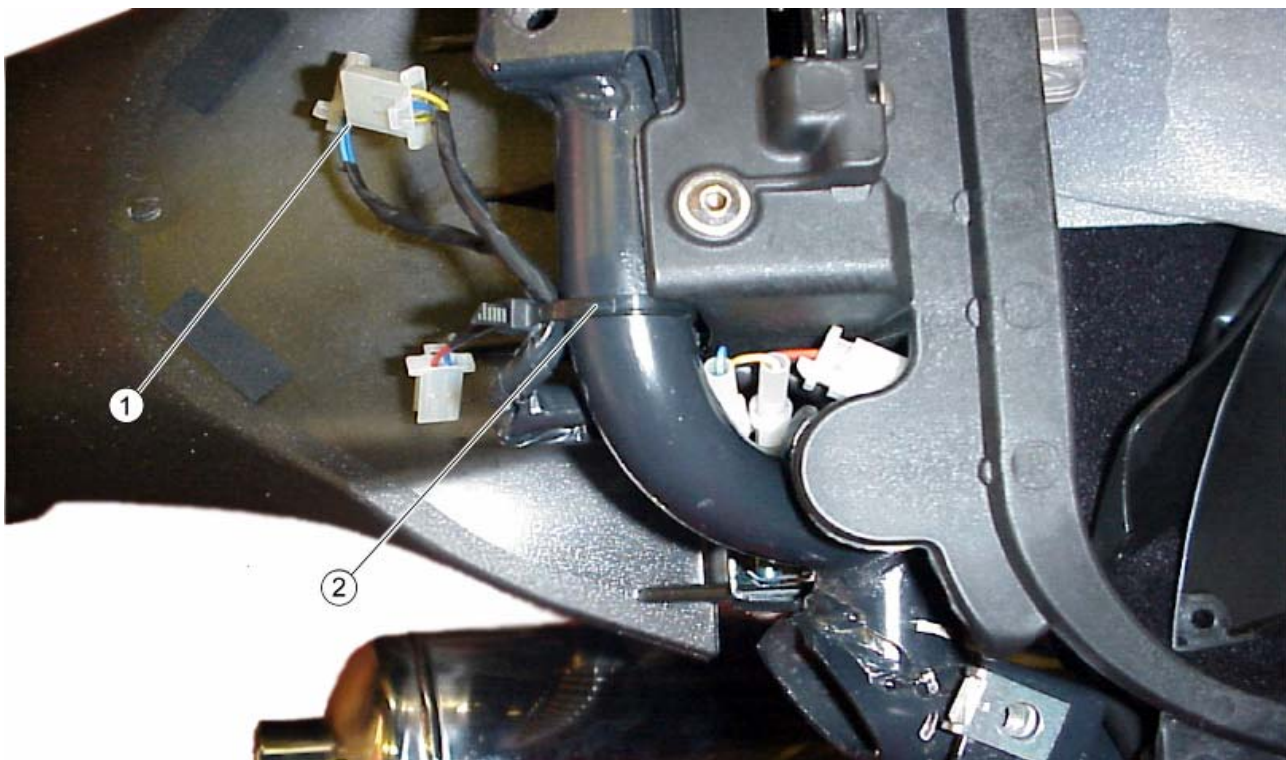

KEY:

- 1. Glove-box Light Connector
- 2. 180 x 4.5 Clamp



KEY:

- 1. 180 x 4.5 Clamp
- 2. 290 x 4.5 Clamp
- 3. The cable harness must be under the cable guide
- 4. 290 x 4.5 Clamp

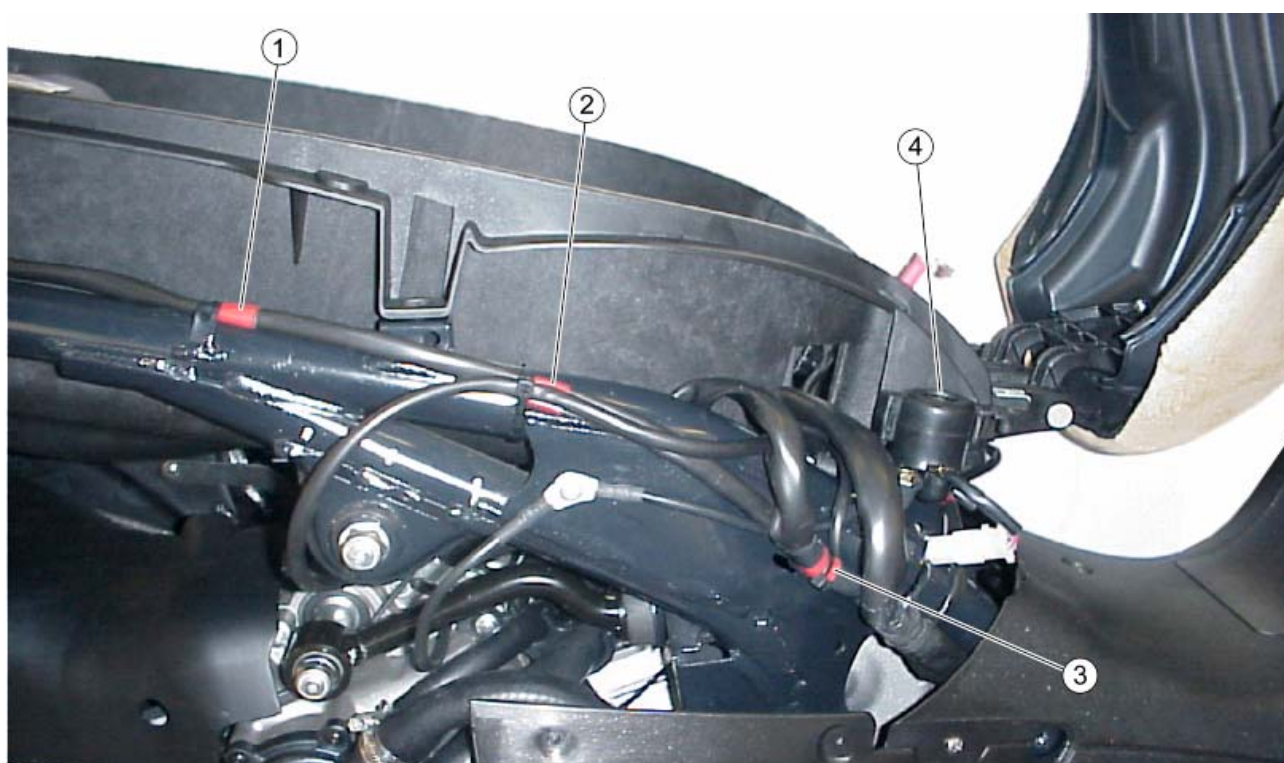

KEY:

1. The cable harness must be under the cable guide
2. 290 x 4.5 Clamp
3. 290 x 4.5 Clamp
4. Start-up relay

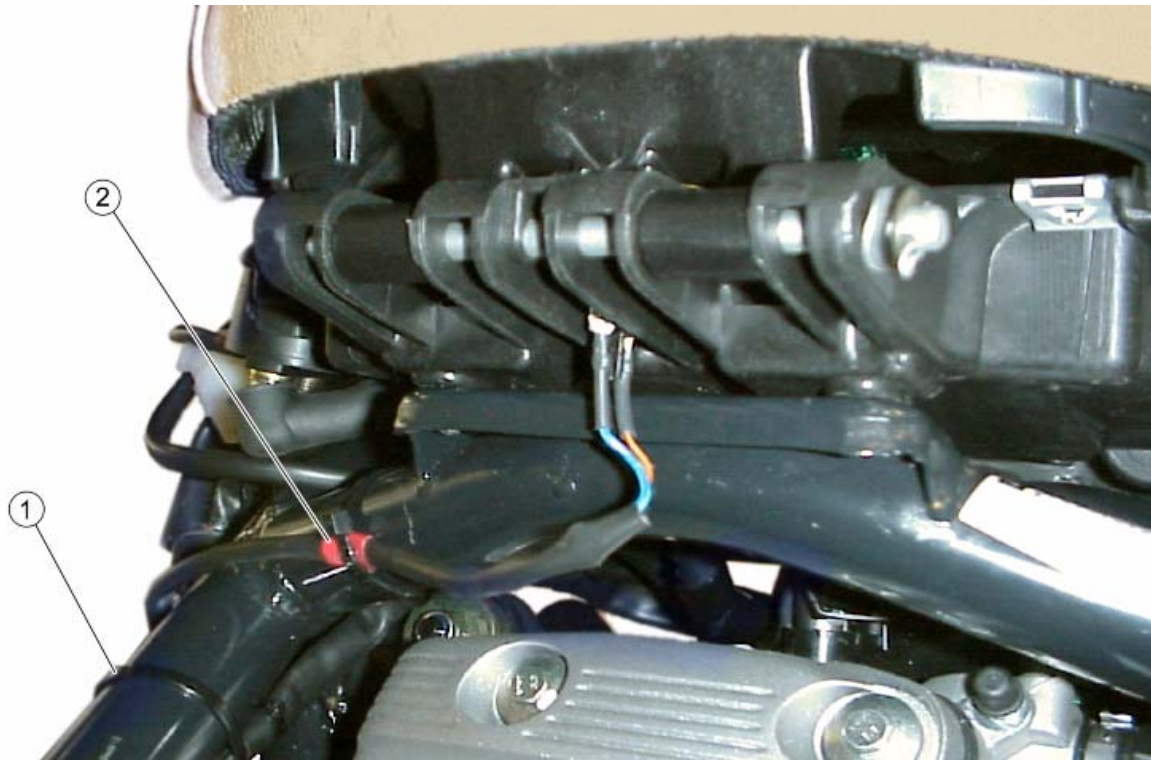
**KEY:**

1. 290 x 4.5 Clamp
2. 180 x 4.5 Clamp



KEY:

- 1. Cable harness installation inside the Battery Compartment



KEY:

- 1. Cable harness installation inside the Battery Compartment

**KEY:**

1. The Oil Pressure Bulb cable is inside the specific cable guide fitted on the engine.
2. The Oil Pressure Bulb cable crosses behind the engine breather pipe.

**KEY:**

1. Flywheel Cable output part

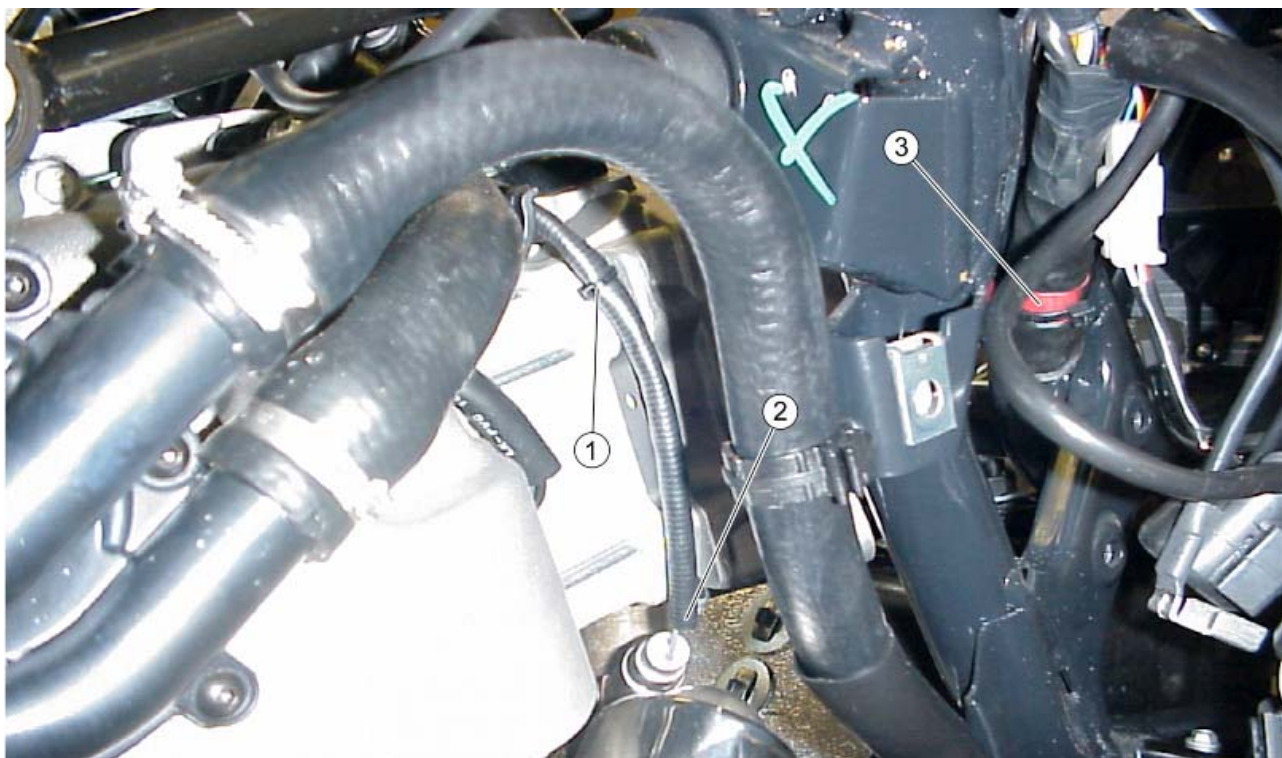

KEY:

- 1. 98 x 2.5 Clamp
- 2. LAMBDA probe
- 3. 290 x 4.5 Clamp

CHASSIS - ENGINE GROUND LEAD FITTING



KEY:

- 1. Screw
- 2. Screw

START-UP RELAY - STARTER MOTOR CABLE FITTING



KEY:

- 1. 290 x 4.5 Clamp



KEY:

1. 290 x 4.5 Clamp

2. Cable guide

LICENSE PLATE LIGHT CABLE HARNESS FITTING

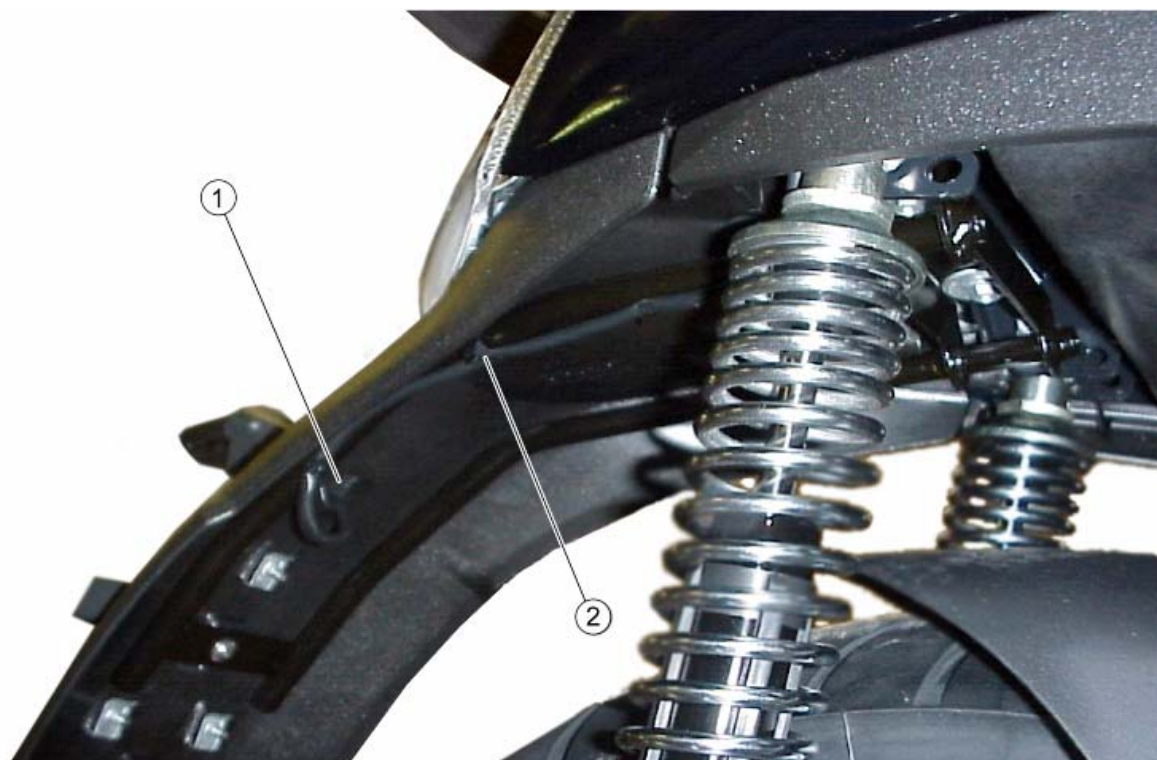

KEY:

1. 180 x 4.5 Clamp
2. 180 x 4.5 Clamp

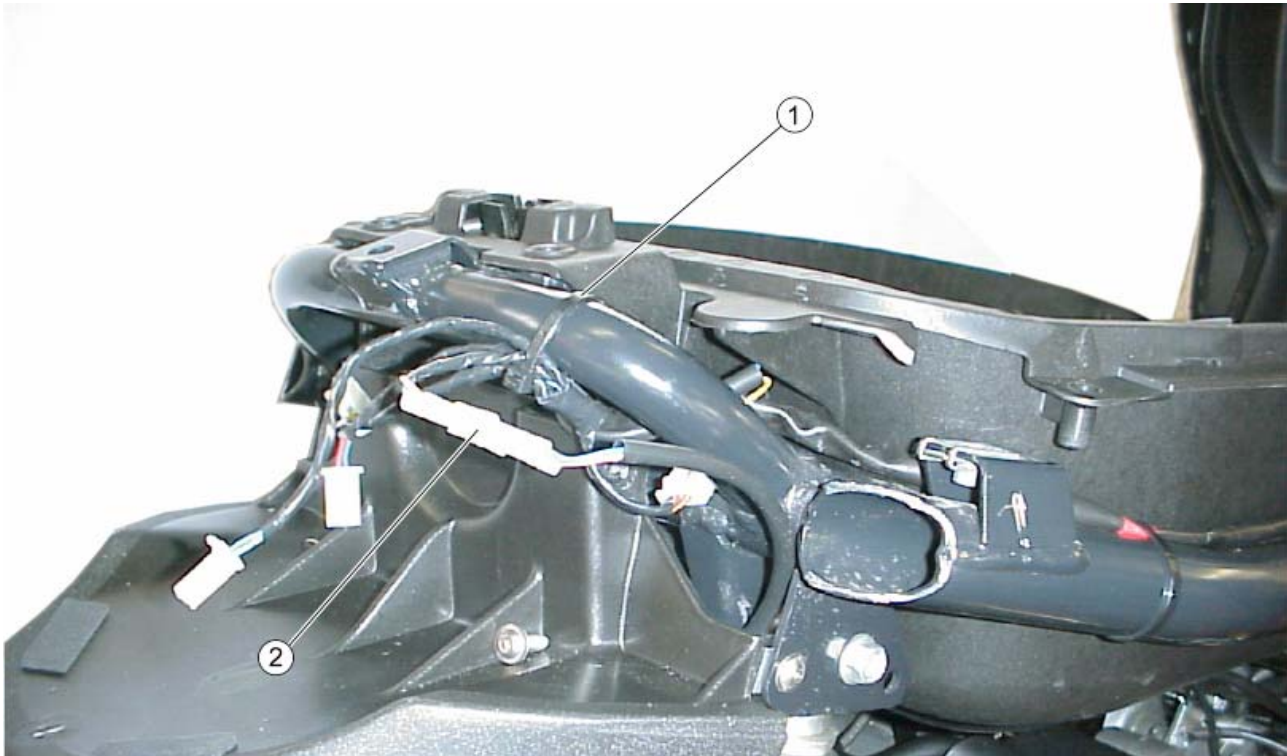
**KEY:**

1. 180 x 4.5 Clamp
2. License Plate Light Connector

Checks and inspections

Battery recharge circuit

The recharge system consists of a three-phase generator with a permanent magneto flywheel.

The generator is directly connected to the voltage regulator.

This, in its turn, is connected directly to the ground lead and the battery positive terminal passing through the 30A protective fuse.

This system requires, therefore, no connection to the key switch.

The three-phase generator allows a significant recharge power and at lower revs a good rapport is achieved between generated power and idle stability.

Stator check

Stator winding check

WARNING**THIS CHECK CAN BE PERFORMED WITH THE STATOR PROPERLY INSTALLED**

- 1) Remove the central cover.
- 2) Disconnect the connector between the stator and the regulator located near the fuel pump.
- 3) Measure the resistance between each yellow terminal and the other two.

Electric characteristic

Resistance:

0.2 ÷ 1 Ω

- 4) Check that there is insulation between each yellow cable and the ground lead.
- 5) If incorrect values are detected, replace the stator.



Recharge system voltage check

Maximum generated current check

- With the engine off and the panel set to «ON» turn on the vehicle lights and let the battery voltage reach up to 12V.
- Connect an ammeter clamp to the 2 charging positives in the regulator output.
- Keep lights on, start the engine, take it to a high running speed and, at the same time, read the values on the ammeter.

With an efficient battery the following value must be detected: > 20A

VOLTAGE REGULATOR/RECTIFIER

Specification	Desc./Quantity
Type	Three-phase, non-adjustable, transistor
Voltage	14 ÷ 15V at 5000 rpm with lights off

Charging voltage check

WARNING

BEFORE CHECKING, MAKE SURE THAT THE BATTERY IS IN GOOD WORKING ORDER.

- 1) Rest the vehicle on its centre stand.
- 2) With the battery properly connected to the circuit, place the multimeter probes between the battery poles.
- 3) Start the engine, making sure that lights are off, increase the engine revs and, at the same time, measure the voltage.

Electric characteristic

Voltage between 14.0 and 15.0 V at 5000 rpm.

Finding possible leaks

- 1) Access the battery by removing the corresponding cover under the saddle.
 - 2) Before checking the output voltage, check that the battery does not show fluid leaks.
 - 3) Turn OFF the ignition key, connect the multimeter probes between the battery negative (-) pole and the Black cable and only then disconnect the Black cable from the battery negative (-) pole.
 - 4) With the ignition key always set to OFF, the reading detected by the ammeter must be ≤ 0.5 mA.
-

Turn signals system check

The turn indicator circuit is controlled by the instrument panel. If it does not operate correctly:

- Check that bulbs operate properly.
 - Check that the Red-Blue, Blue-Black and Light blue-White cables between the turn indicator switch and the instrument panel connector (terminals 7, 15 and 6) are not interrupted.
 - Check if there is a ground connection on the Blue-White cable of the turn indicator switch.
 - Check the turn indicator switch contacts.
 - Check if, with the turn indicator switch pressed to the left, there is voltage between terminal 16 (Light blue cable) of the instrument panel and the ground lead.
 - Repeat the procedure, with the turn indicator switch pressed to the right, for terminal 17 (Red cable).
 - Check that the Light blue cable (terminal 16) between the instrument panel connector and the left turn indicator bulbs is not interrupted.
 - Check that the Red cable (terminal 17) between the instrument panel connector and the right turn indicator bulbs is not interrupted.
-

Lights list**Tail light and instrument panel light line**

- Check that bulbs operate properly.
- Check that fuse C operates properly.
- With the key switch set to «ON», check if there is voltage between the Green cable of fuse C and the ground lead.
- Check that cable harness between bulbs and fuse C (Green cable) is not interrupted.

High/low-beam light line

- Check that bulbs operate properly.
 - Check that Green cables between the light switch and fuse C are not interrupted.
 - Check the light switch contacts.
-

- Check that the Black cable between the light switch and the low-beam light bulb is not interrupted.
- Check that the White cable between the light switch and the high-beam light bulb is not interrupted.

Fuses

The electrical system has seven fuses (plus four reserve fuses) grouped in two fuse terminal blocks.

The chart shows the position and characteristics of the fuses.

CAUTION

BEFORE REPLACING A BLOWN FUSE, FIND AND SOLVE THE PROBLEM THAT CAUSE IT TO BLOW.

NEVER ATTEMPT TO REPLACE A FUSE WITH ANY OTHER MATERIAL (A PIECE OF ELECTRIC WIRE) OR A FUSE WITH A HIGHER AMPERAGE THAN REQUIRED.

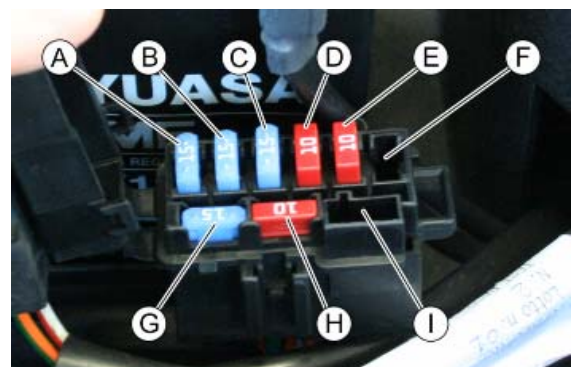
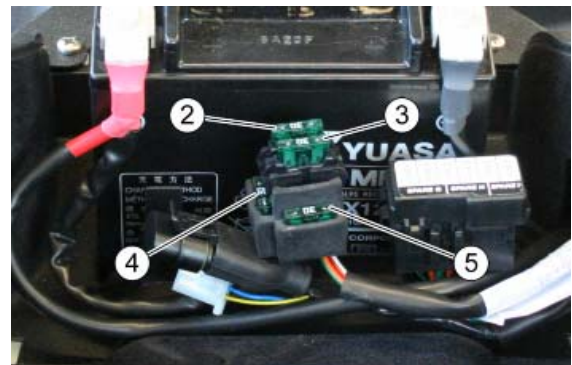

MAIN FUSES

	Specification	Desc./Quantity
1	Fuse No. 2	Capacity: 30A Protected circuits: battery recharge circuit, fuse B.
2	Fuse No. 3	Capacity: 30A Protected circuits: fuse D, fuse E, instrument panel. Live: fuse A, fuse C, antitheft device control unit.
3	Fuse No. 4	Spare fuse 30A
4	Fuse No. 5	Spare fuse 30A

AUXILIARY FUSES

	Specification	Desc./Quantity
1	Fuse A	Capacity: 15 A Protected circuits: start-up circuit, injection load, injection relay, fan relay, injection ECU, stop lights.
2	Fuse B	Capacity: 15 A Protected circuits: Plug socket.

	Specification	Desc./Quantity
3	Fuse C	Capacity: 15 A Protected circuits: Instrument panel, horn, tail lights, high-beam light, low-beam light.
4	Fuse D	Capacity: 10A Protected circuits: Lighting and electronic lock of the helmet compartment, antitheft device control unit.
5	Fuse E	Capacity: 10A Protected circuits: fan, injection ECU.
6	Fuse F	Free
7	Fuse G	Spare fuse 15A
8	Fuse H	Spare fuse 10A
9	Fuse I	Free

Dashboard

Data check function

SERVICE

When the vehicle is started and right after the ignition check, if there are less than 300 km (200 mi) left to the next Service, the specific icon flashes for 5 seconds. Once the service mileage has been reached, the icon remains steadily until the Service is reset.

The warning light can be zero set even if the mileage is lower, up to 300 km (200 mi), compared with the Service mileage. During the 300 km (200 mi) before the service warning light comes on, the light flashes 5 times each time the key is set to "ON".

The light should turn on first at 1000 km (625 mi). Successive times are strictly at 10000 km (6215 mi), 20000 km (12430 mi), etc.

RESET

Hold the MODE button down.

Turn the key to "ON" and wait 10 seconds.

During this operation the service icon flashes at a 1 Hz frequency.

Sealed battery

Commissioning sealed batteries

If the vehicle is fitted with a sealed battery, the only maintenance required is to check the battery charge and to recharge it, if required. These operations should be carried out before delivering the vehicle, and on a six-month basis during an open circuit storage. Besides pre-delivery, it is therefore necessary to check the battery charge and recharge it, if required, before storing the vehicle and every six months once it is stored.

INSTRUCTIONS FOR BATTERY REFRESH AFTER OPEN CIRCUIT STORAGE

1. Voltage check

2.
 - Before installing the battery on the vehicle, check the open circuit voltage with a regular multimeter.
 - If voltage is over 12.60V, the battery can be installed without any refresh.
 - If voltage is below 12.60 V, a refresh recharge is required as explained in point 2).

3. Constant voltage battery charge mode

4.
 - Constant voltage charge equal to 14.40÷14.70V
 - Initial charge current equal to 0.3÷0.5 of the battery nominal capacity
 - Charge time:
 - 10 to 12 h recommended Minimum 6 h Maximum 24 h

5. Constant voltage battery charge mode

6.
 - Charge current equal to 1/10 of the battery nominal capacity

Dry-charge battery

WARNING



THE BATTERY ELECTROLYTE IS POISONOUS AS IT MAY CAUSE SERIOUS BURNS. IT CONTAINS SULPHURIC ACID. AVOID CONTACT WITH THE EYES, SKIN AND CLOTHING. IF IN CONTACT WITH EYES OR SKIN, WASH ABUNDANTLY WITH WATER FOR APPROX. 15 MIN. AND SEEK IMMEDIATE MEDICAL ATTENTION. IN ACCIDENTALLY SWALLOWED, IMMEDIATELY DRINK LARGE QUANTITIES OF WATER OR MILK, FOLLOWED BY MAGNESIUM MILK, BATTERED EGG OR VEGETABLE OIL. SEEK IMMEDIATE MEDICAL ATTENTION. BATTERIES PRODUCE EXPLOSIVE GASES; KEEP AWAY FROM NAKED FLAMES, SPARKS OR CIGARETTES; VENTILATE THE AREA WHEN RECHARGING INDOORS. ALWAYS WEAR EYE PROTECTION WHEN WORKING IN THE PROXIMITY OF BATTERIES. KEEP OUT OF THE REACH OF CHILDREN

- Remove the short closed tube and the plugs, then pour sulphuric acid into the cells using the type specified for batteries, with a specific gravity of 1.26, corresponding to 30° Bé, at a minimum temperature of 15°C until the upper level is reached.
- Leave to rest for at least 2 hours, then restore the level with sulphuric acid.
- Within the following 24 hours, recharge with the specific battery charger at a density of about 1/10 of the battery nominal capacity and until the acid

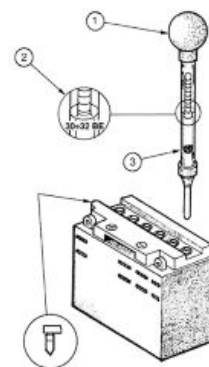

density is about 1.27, corresponding to 31° Bé, and these values are stabilised.

- Once the charge is over, level the acid (by adding distilled water). Close and clean carefully.
- Once the above operations have been performed, install the battery on the vehicle making sure that it is properly wired up.

1 Hold the tube upright

2 Carry out a visual inspection

3 The float must be released

Electrolyte level check

The electrolyte level must be checked frequently and must reach the upper level. Only use distilled water to restore this level. If it is necessary to add water too frequently, check the vehicle electrical system: the battery works overcharged and is subject to quick wear.

Charge status check

After topping-up the electrolyte level, check its density using the appropriate densitometer.

With the battery charged, a density of 30÷32 Bé, corresponding to a specific weight of 1.26÷1.28, must be at a minimum temperature of 15° C.

A density reading below 20° Bé indicates that the battery is completely flat and must therefore be recharged.

If the vehicle is not used for a certain time (1 month or more), the battery needs to be recharged periodically.

The battery runs down completely in about three months. Should the battery be refitted on the vehicle, be careful not to invert its connections, keeping in mind that the (**black**) earth wire marked (-) is connected to the - **negative** terminal whereas the other two **red** wires marked (+) are connected to the + **positive** terminal.

Battery recharge

WARNING



BEFORE RECHARGING THE BATTERY, REMOVE THE PLUGS OF EACH CELL. KEEP OPEN FLAMES OR SPARKS AWAY FROM THE BATTERY WHILE CHARGING.

First detach the negative terminal before removing the battery from the vehicle.

Normal bench charging must be performed using the special battery charger, setting the battery charge selector to the type of battery to be recharged (therefore, at a current equivalent to 1/10 of the battery

nominal capacity). Connections to the power supply source must be implemented by connecting corresponding poles (+ to + and - to -).

The battery should always be kept clean, especially its top side, and the terminals should be coated with petroleum jelly.

CAUTION

NEVER USE FUSES WITH A CAPACITY HIGHER THAN THE RECOMMENDED CAPACITY. USING A FUSE OF UNSUITABLE RATING MAY SERIOUSLY DAMAGE THE VEHICLE OR EVEN CAUSE A FIRE.

CAUTION

ORDINARY DRINKING WATER CONTAINS MINERAL SALTS THAT ARE HARMFUL TO THE BATTERY. CONSEQUENTLY, ONLY USE DISTILLED WATER.

CAUTION

TO ENSURE MAXIMUM PERFORMANCE, THE BATTERY MUST BE CHARGED BEFORE USE. INADEQUATE CHARGING OF THE BATTERY BEFORE IT IS FIRST USED SHORTENS THE BATTERY LIFE.

Connectors

INDEX OF TOPICS

ENGINE FROM VEHICLE

ENG VE

Exhaust assy. Removal

- Loosen the clamp of the exhaust manifold.



- Undo and remove the screw fixing the exhaust end sealing clamp.
- Push in the exhaust and remove the upper pin fixing the sealing clamp.



- Undo and remove the exhaust end fixing screw.



- Remove the exhaust end.



- Remove the tail section.
- Disconnect the lambda probe connector.
- Unscrew the two nuts fixing it to the head.
- Remove the manifold with the gasket.



Removal of the engine from the vehicle

- Rest the vehicle on its centre stand.
- Remove the tail section.



- Remove the helmet compartment.



- Loosen the clamp.

NOTE

USE A CONTAINER OF ADEQUATE CAPACITY TO COLLECT THE FLUID THAT MAY LEAK DURING OPERATION.



- Slide off the pipe.
- Drain off the system.

NOTE

REMOVE THE EXPANSION TANK CAP TO FACILITATE COOLANT DRAINAGE.



- Working on the right side of the vehicle, undo and remove the two side screws fixing the rear mudguard; collect the two shim washers.



- Working on the left side of the vehicle, undo and remove the two side screws fixing the rear mudguard; collect the two washers.

NOTE

UPON REFITTING, PAY ATTENTION TO THE LENGTH OF THE FIXING SCREWS, THE REAR SCREW IS SHORTER.

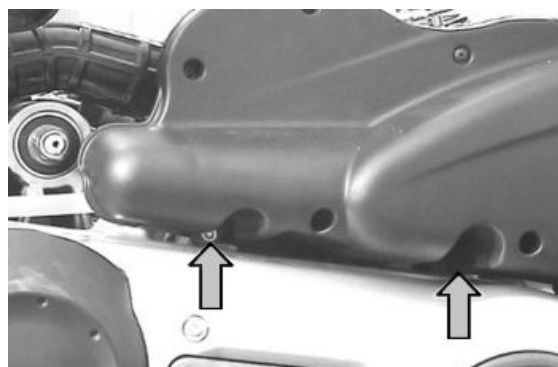

- Remove the mudguard.



- Undo and remove the screw fixing the oil scavenge flange.



- Slide the flange off its seat.



- Undo the screw of the air filter internal support.



- Loosen the intake manifold clamp.
- Remove the clamp indicated.



- Slide off the bleed pipe.



- Remove the filter housing.



- Prepare the hoist and secure the motor vehicle properly with the hoisting belt.

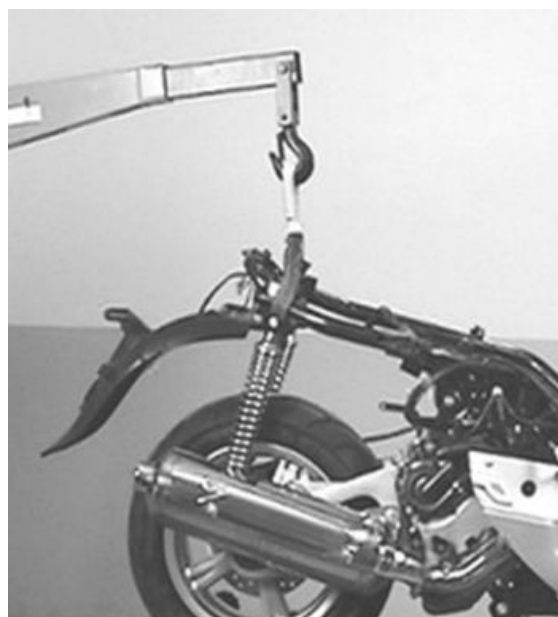

- Undo and remove the upper screw fixing the right shock absorber and collect the nut.



- Detach the shock absorber.



- Undo the lower screw fixing the rear left shock absorber and collect the nut.

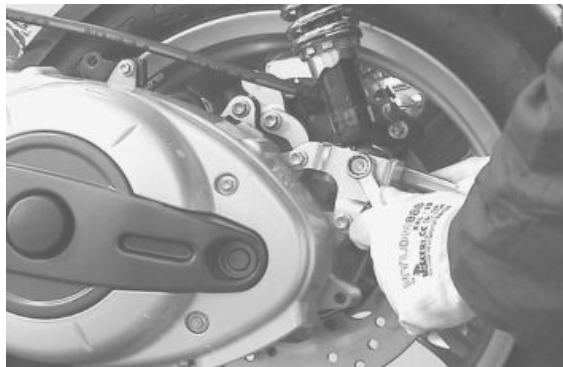

- Detach the shock absorber.

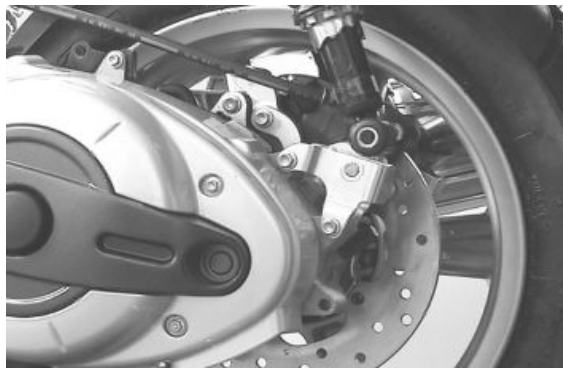

- Loosen the set screws and slide off the throttle control cables.



- Loosen the clamp of the thermostatic valve.
- Disconnect the pipes.

NOTE

USE A CONTAINER OF ADEQUATE CAPACITY TO COLLECT THE FLUID THAT MAY LEAK DURING OPERATION.



- Remove the spark plug tubes.



- Remove the injector control sensor.



- Slide off the fuel pipe.
- Undo and remove the fuel pipe fixing screw.



- Disconnect the coolant temperature sensor.

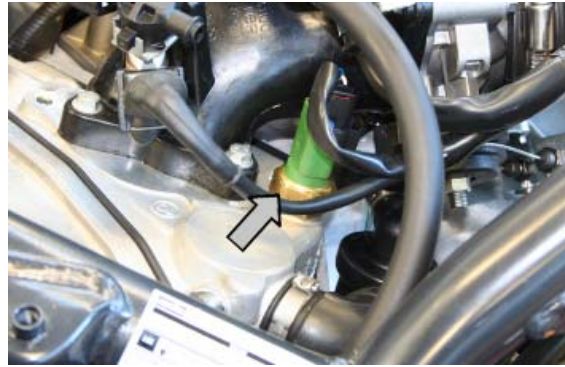

- Disconnect the lambda probe connector.
- Release the cables from the cable guide clamp.

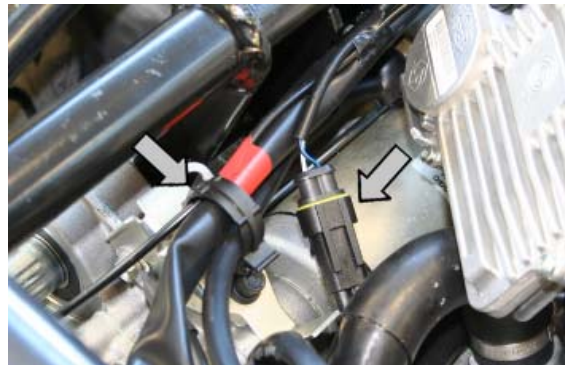

- Disconnect the MIU control unit connector and remove the fixing screw from the retainer clamp.

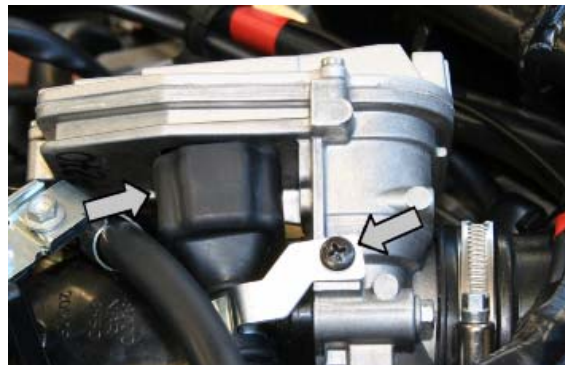

- Undo and remove the screw fixing the ground leads.



- Disconnect the oil pressure sensor.

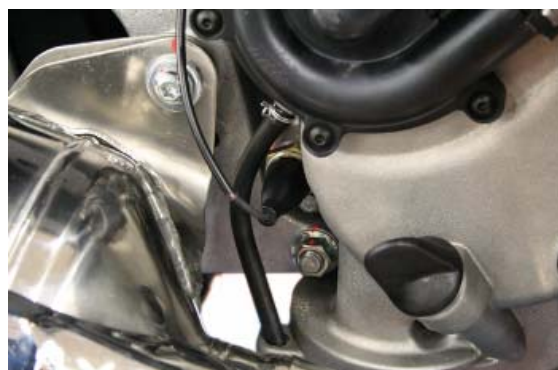

- Working on both sides, undo and remove the side screw fixing the chassis central cover.



- Slightly lift the chassis central cover.
- Disconnect the voltage regulator connector and the revolution sensor connector.



- Remove the clamp.



- Loosen the clamp of the exhaust manifold.



- Undo and remove the screw fixing the exhaust end sealing clamp.
- Push in the exhaust and remove the upper pin fixing the sealing clamp.



- Undo and remove the exhaust end fixing screw.
- Remove the exhaust end.



- Remove the safety split pin.

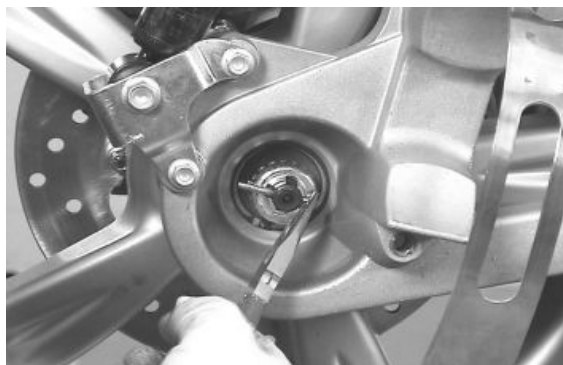

- Remove the cap.



- With the help of a second operator, operate the rear brake; unscrew and remove the rear nut fixing the muffler supporting bracket.

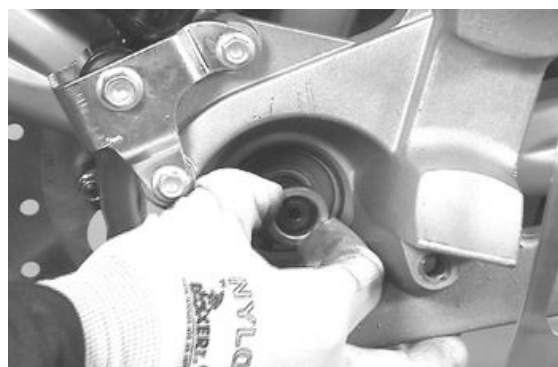

- Unscrew and remove the two front nuts fixing the muffler supporting plate.

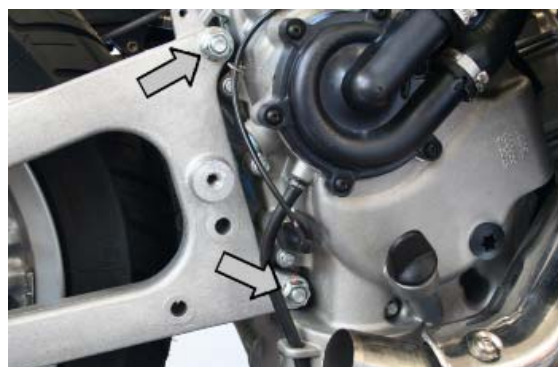

- Remove the muffler supporting plate.



- Remove the spacer.
- Undo and remove the five screws fixing the wheel.
- Remove the wheel.

NOTE

PLACE AN ADEQUATE SUPPORT AT THE LOWER PART OF THE MOTOR VEHICLE.



- Undo and remove the screw fixing the rear brake pipe and collect the spacer.

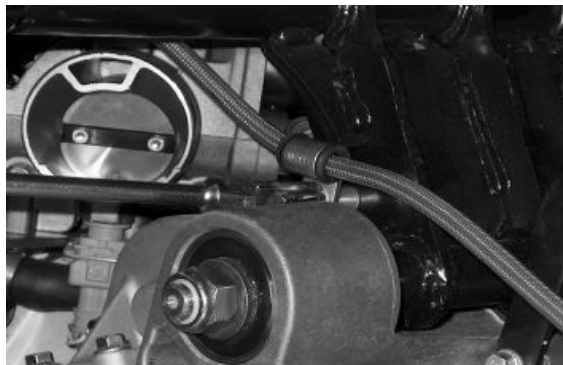

- Undo and remove both screws fixing the rear brake calliper.
- Detach the calliper.

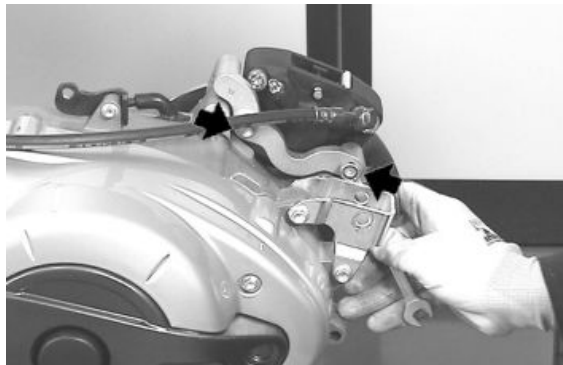

- Move the protection casing.



- Unscrew and remove the positive lead fixing nut.
- Release the positive lead.



- Working on the right side, unscrew the nut fixing the swinging arm pin and collect the washer.



- Unscrew and remove the link rod fixing nut and collect the washer and the silent block.



- Unscrew the pin and collect the washer.
- The engine is now free.



- Upon refitting the engine onto the vehicle, carry out the removal operations but in reverse order, observing the tightening torques shown in the «Specifications» Chapter.
- Check the engine oil level and, if necessary, top up with the recommended type of oil.
- Fill and bleed the cooling circuit.
- Check the throttle grip and electrical devices for correct operation.

CAUTION

PAY SPECIAL ATTENTION TO PLACE THE THROTTLE CONTROL TRANSMISSION PROPERLY.

INDEX OF TOPICS

ENGINE

ENG

This section describes the operations to be carried out on the engine and the tools required.

Automatic transmission

Transmission cover

- Undo the 4 fixing screws.
- Take out the plastic external transmission cover.



- Using a screwdriver, remove the driven pulley axis cover by acting on the bottom of the cap.



- Loosen the nut fixing the driven pulley shaft using an offset wrench and prevent pulley shaft rotation using an industrial-type hexagonal socket wrench.
- Remove the nut plus both washers.

NOTE

DUE TO THE HIGH TIGHTENING TORQUE, USING DIFFERENT WRENCHES (TRADITIONAL MULTI-POINT SOCKET WRENCH) MAY DAMAGE THE HEXAGON LOCATED ON THE SHAFT OR BREAK THE BUSHING.



- Remove the six M6 screws.



- Remove the four M8 screws.
- Remove the transmission cover.
- Check that the bearing rotates freely; otherwise, replace it.



Air duct

- Remove the transmission cover.
- To remove the air deflector, undo the two screws indicated in the figure.

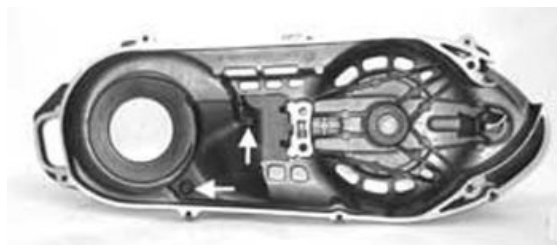

Locking torques (N*m)

Air deflector screws 11 ÷ 12

- Remove the external transmission cover.
- Undo the 4 fixing screws indicated in the figure to remove the external air deflector.

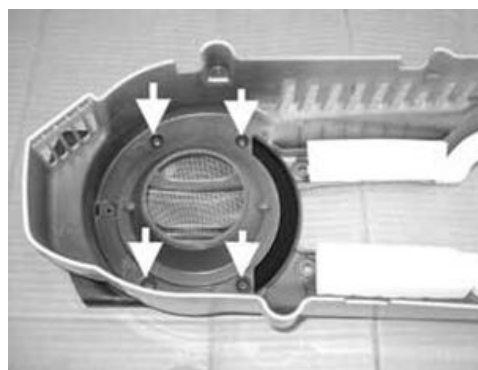

Air duct filter

- Remove the external air deflector.
- Undo the 2 fixing screws indicated in the figure to remove the deflector filter.



Removing the driven pulley shaft bearing

- Remove the transmission cover.
- Remove the Seeger ring.



- Place the transmission cover on a wooden surface and use the specific tool so that it is adequately supported.
- Extract the bearing with the specific tool.

NOTE

BELL MUST BE PLACED INTO THE TRANSMISSION COVER, CLOSE TO THE BEARING SEAT AND THE WOODEN SURFACE, SINCE WITHOUT BELL THE ENTIRE COVER STRUCTURE WOULD BEND; NOT ONLY IN THE AREA OF MAXIMUM STURDINESS.

Specific tooling

001467Y002 Driver for bearing with OD 73 mm

020376Y Adaptor handle

020375Y 28 x30 mm Punch

020439Y 17-mm guide for oil seal



Refitting the driven pulley shaft bearing

- Heat the internal side of the transmission cover with a heat gun.

NOTE

BE CAREFUL NOT TO OVERHEAT THE COVER AS THIS WOULD DAMAGE THE EXTERNAL PAINTED SURFACE.

Specific tooling

020151Y Air heater

020150Y Air heater support



- Fit the bearing onto the specific tool with a little grease to prevent it from coming out.
- Refit the new bearing with the specific tool.

NOTE

PROPERLY SUPPORT THE EXTERNAL COVER TO PREVENT DAMAGING THE PAINTED SURFACE.

Specific tooling

020376Y Adaptor handle

020358Y 37 x 40 mm adaptor

020439Y 17-mm guide



Baffle roller

Plastic roller

- Check that the roller shows no signs of abnormal wear and that it rotates freely.
- Undo the fixing screw with a 13-mm spanner.
- Remove the roller together with the bearing.

NOTE

IF THE ROLLER DOES NOT ROTATE FREELY, REPLACE THE COMPLETE ROLLER.



Belt anti-flapping roller fitting

- Fit the belt anti-flapping roller with the belt containment edge on the engine crankcase side.
- Tighten the central screw to the prescribed torque.

NOTE

TURN THE DRIVEN AND/OR DRIVING PULLEY UNTIL THE BELT IS CORRECTLY TAUTENED.

Locking torques (N*m)

Anti-flapping roller screw 16.7 ÷ 19.6

Removing the driven pulley

- Slide off the clutch bell.

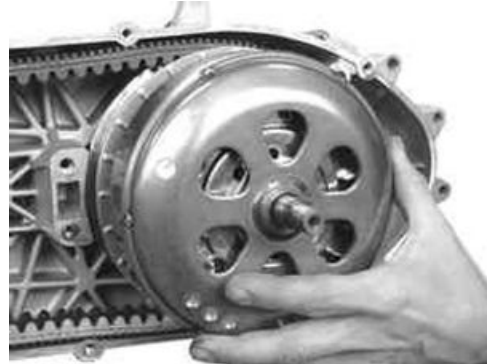

- Remove the fixed driving half-pulley.
- Slide off the driven pulley unit together with the belt.



Inspecting the clutch drum

- Make sure that the clutch bell is not worn or damaged.
- Measure the clutch bell inside diameter.

NOTE

CHECK THE ECCENTRICITY FOUND; IT SHOULD BE 0.2 MM MAX.

Characteristic**Max. value:**

160.5 mm

Standard value:

160.2 mm



Inspecting the clutch

- Check the thickness of the clutch mass friction material.

Characteristic**Minimum thickness allowed:**

1 mm

- The masses must not show traces of lubricants. If they do, check the driven pulley unit seals.

NOTE

UPON RUNNING-IN, THE MASSES MUST EXHIBIT A CENTRAL FAYING SURFACE AND MUST NOT BE DIFFERENT FROM ONE ANOTHER. DIFFERENT CONDITIONS MAY CAUSE CLUTCH TEARING.

- To avoid variation in the return spring load, do not use any tool to open the masses.

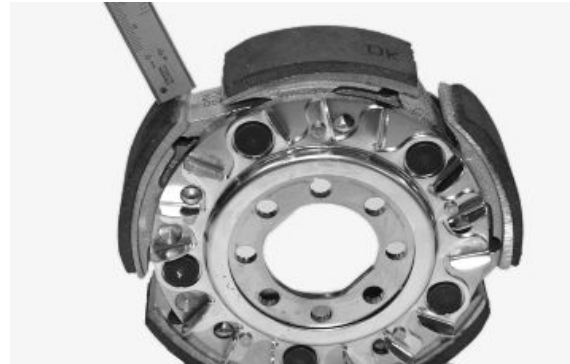

Removing the clutch

- To remove the clutch assembly from the driven pulley, use the specific tool;
- Arrange the tool with the pins half-screwed into position «E» on the inside;
- Fit the adaptor ring on the clutch assembly as indicated in the photograph.
- Fit the driven pulley unit on the tool by inserting the pins in the ventilation holes;
- Push the rear stop screw until it stops against the fixed driven pulley as shown in the figure.

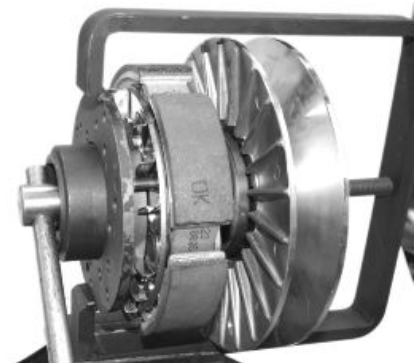

CAUTION

THE TOOL SHOULD BE FIRMLY SECURED IN A VICE USING THE SPECIFIC TOOL. DO NOT TIGHTEN THE REAR SCREW TOO MUCH AS THIS COULD IRRETRIEVABLY DEFORM THE TOOL.

REMOVE THE FIXING RING NUT USING THE APPROPRIATE 55-MM SPANNER. UNDO THE TOOL SCREW AND DISASSEMBLE THE DRIVEN PULLEY UNIT, CLUTCH, AND SPRING WITH SHEATH.

Specific tooling

AP8140259 Tool for fitting/removing the clutch on the driven pulley

Pin retaining collar

- Slide off the collar with the aid of 2 screwdrivers.



-
- Remove the 4 guide pins.
 - Slide off the movable driven half-pulley.



Removing the driven half-pulley bearing

- Check there are no signs of wear or damage on the bushing; otherwise, replace the fixed driven half-pulley.
- Remove the snap ring with pliers.



-
- With the specific tool inserted through the roller bearing, pull out the ball bearing.

NOTE

PROPERLY SUPPORT THE PULLEY TO PREVENT DAMAGING THE THREADING.

Specific tooling

020376Y Adaptor handle

020456Y Ø 24-mm adaptor

020363Y 20-mm Oil seal guide

NOTE



TO SERVICE THE BEARINGS ON A FITTED DRIVEN PULLEY UNIT, SUPPORT THE UNIT BY THE BELL.

Specific tooling

001467Y002 Driver for bearing with OD 73 mm

- Remove the roller bearing with the specific tool, supporting the fixed half-pulley with the bell.

Specific tooling

020376Y Adaptor handle

020375Y 28 x30 mm Punch

020364Y 25-mm guide

001467Y002 Driver for bearing with OD 73 mm



Inspecting the driven fixed half-pulley

- Check that the belt faying surface does not show signs of wear.
- Measure the outside diameter of the pulley bushing.

Characteristic

Minimum diameter allowed:

49.96 mm

Standard diameter:

49.965 mm



Inspecting the driven sliding half-pulley

- Check that the belt faying surface does not show signs of wear.
- Remove the 2 inner sealing rings and the 2 external O-rings.
- Measure the inside diameter of the movable half-pulley bushing.

Characteristic

Maximum diameter allowed:

50.08 mm

Standard diameter:

50.085 mm



Refitting the driven half-pulley bearing

- Fit a new roller bearing with the specific tool.

NOTE

PLACE THE BEARING WITH THE WORDS AND THE BUILT-IN OIL SEAL FACING OUTWARDS.

- Properly support the half-pulley to prevent damaging the threading.

If you are working on the driven pulley assembly fully fitted, use the specific tool.

Specific tooling

020478Y Punch for roller casing

001467Y002 Driver for bearing with OD 73 mm



-
- Fit a new ball bearing with the specific tool.

Specific tooling

020376Y Adaptor handle

020477Y 37-mm adaptor

020363Y 20-mm Oil seal guide



- Fit the Seeger ring.

Refitting the driven pulley

- Fit the new oil seals.

- Fit the new O-rings.

NOTE

THE O-RINGS COME IN TWO DIFFERENT SIZES. THE LARGE ONE IS FITTED ON THE MACHINING END RADIUS; AT THE BASE OF THE HALF-PULLEY.

- Fit the half-pulley on the bushing being careful not to damage the top sealing ring.
- Make sure the pins and collar are not worn and refit the pins and the collar.



- Using a curved-spout grease gun, lubricate the driven pulley assembly with approximately 10 grams of grease. Apply the grease through one of the holes in the bushing until grease comes out through the hole on the opposite side. This procedure is necessary to prevent the presence of grease beyond the O-rings.

Recommended products

AGIP GREASE SM 2 Grease for C-ring of the tone wheel

Soap-based lithium grease containing NLGI 2 Molybdenum disulphide 2; ISO-L-XBCHB2, DIN KF2K-20

Inspecting the clutch spring

- Measure the length of the movable driven half-pulley spring when unloaded.

Characteristic

Standard length:

125.5 mm

Limit allowed after use:

120 mm



Refitting the clutch

- Prepare the specific tool as for the removal phase;
- Pre-assemble the driven pulley unit with the driving belt observing its direction of rotation;
- Fit the driven pulley unit, the spring with sheath and clutch into the tool.



Specific tooling

AP8140259 Tool for fitting/removing the clutch on the driven pulley

- Compress the spring and fit the clutch on the driven pulley bushing.

NOTE

BE CAREFUL NOT TO DAMAGE THE SHEATH OR THE BUSHING THREADED END.

- Finger tighten the ring nut and complete the tightening to the prescribed torque using the appropriate spanner.

Specific tooling

AP8140259 Tool for fitting/removing the clutch on the driven pulley

Locking torques (N*m)

Clutch ring nut 65 - 75

- To facilitate refitting the clutch on the engine, turn the movable driven pulley and insert the belt into the smaller diameter.

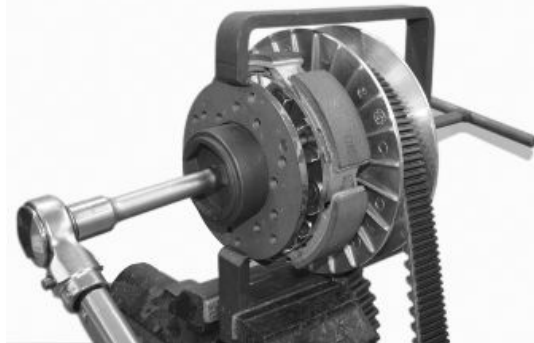
**Refitting the driven pulley**

- Fit the driven pulley unit together with the belt.

**Drive-belt**

- Make sure that the driving belt is not damaged.
- Check belt for correct width.

Characteristic**Minimum width**

27.5 mm

Maximum width

28.7 mm

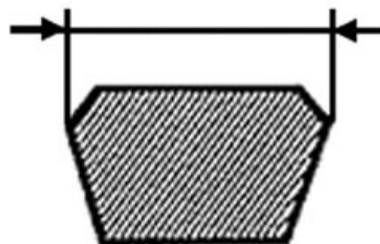

Removing the driving pulley

- Using a 27-mm spanner, turn the pulley central nut to align the central internal holes horizontally and to fit the specific tool.

Specific tooling

020474Y Driving pulley lock wrench



- First fit the 2 retainer clamps of the specific tool into the pulley so that the spline is fully engaged.
- Then, fit the tool so as to insert the stud bolts on the clamp into the holes located in the tool.
- Manually tighten both tool fixing nuts.
- Unscrew the central nut.
- Remove both the belleville and the plain washer.
- Remove the fixed driving half-pulley.
- Remove the connecting washer with the bushing.

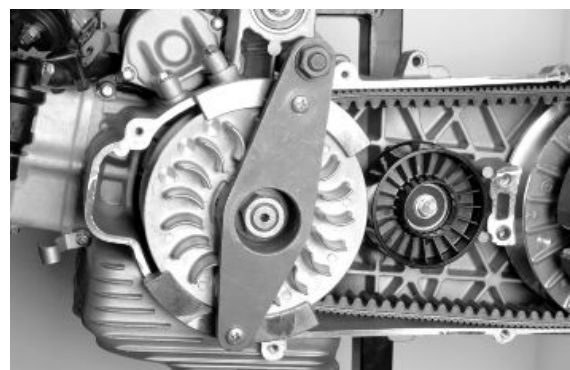

- Move the belt downwards.
- Suitably support the roller contrast and slide off the movable driving half-pulley with the relevant bushing and the rear washer, being careful not to make the rollers come out.



Inspecting the rollers case

- Check that internal bushings shown in the figure are not abnormally worn and measure their inside diameter.

CAUTION

DO NOT LUBRICATE OR CLEAN BUSHINGS

Characteristic

Max. diameter allowed:

30.12 mm

Standard diameter:

30.021 mm

- Measure the outside diameter of the pulley sliding bushing shown in the figure.

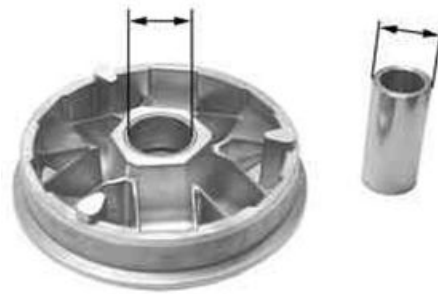
**Characteristic****Minimum diameter allowed:**

Ø 29.95 mm

Standard diameter:

Ø 29.959 mm

- Check that the rollers are not damaged or worn.

Characteristic**Minimum diameter allowed:**

Ø 24.5 mm

Standard diameter:Ø 24.9 mm

- Check the guide shoes for the variator roller contrast plate are not worn.
- Check that there is no wear in the roller housings or the surfaces in contact with the belt on both half-pulleys.



Refitting the driving pulley

Roller container fitting

- Fit the spacer with the internal chamfered side facing the fitting side.



- Place the rollers in the half-pulley as shown in the figure.
- The closed side must rest on the internal thrust side of the roller container.



- Assemble the half-pulley with the roller contrast plate and sliding blocks.



- Fit the half-pulley on the crankshaft.
- Fit the spacer bushing.

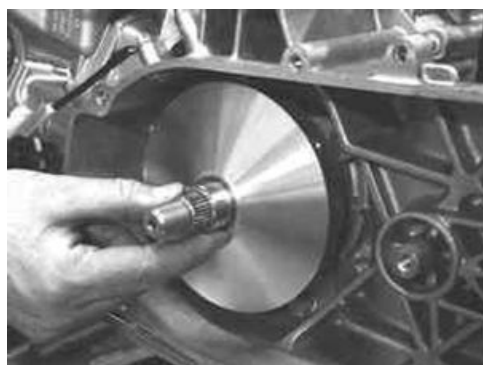

Fixed driving half-pulley fitting

- Fit the spacer.

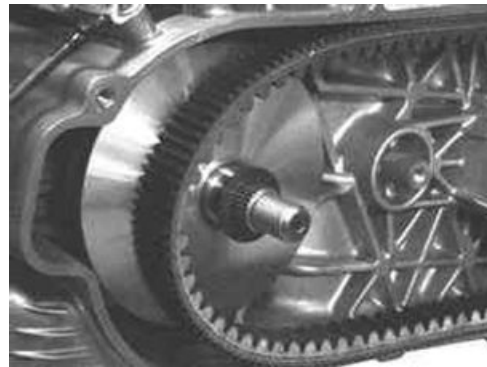

- Fit the fixed driving half-pulley and check that it is in contact with the spacer and with the guide bushing of the movable driving pulley.



- Fit the plain and the belleville washers as shown in the figure.



- Fit the nut in the previous working position (nut side in contact with the belleville washer)



- Turn the pulley central nut so that the pulley holes are aligned horizontally to fit the specific tool.

NOTE

CHECK THAT THE LOCK WRENCH TOOL CAN BE EASILY FITTED INTO THE PULLEY AND IN THE ENGINE CRANKCASE.

Specific tooling

020474Y Driving pulley lock wrench



- Fit the retainer clamp from the rear, so that the spline is fully engaged.
- Finally fit the tool by manually drawing the nuts close and making sure that the tool lays horizontally.
- Tighten the driving pulley fixing nut to the prescribed torque.
- Remove the specific tool.

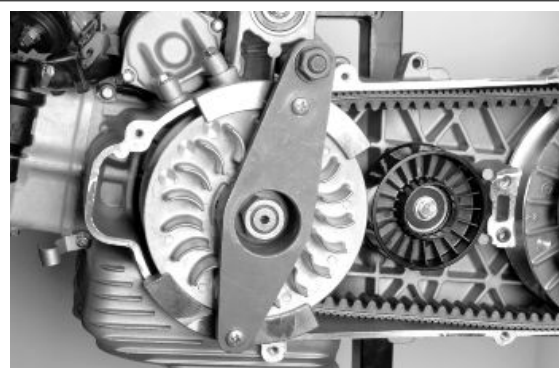

Locking torques (N*m)

Driving pulley nut 160 - 175

Refitting the transmission cover

- Make sure that 2 centring dowels are correctly inserted in the crankcase.



- Fit the transmission cover with the bearing and fit the relevant retainers.
- Lock the four M8 retainers.

Locking torques (N*m)

Transmission cover M8 retainers 23 ÷ 26



- Lock the 7 M6 retainers.

Locking torques (N*m)

M6 Retainer 11 ÷ 13



- Fit the washers on the driven pulley shaft.

NOTE

FIT THE WASHER WITH THE SMALLER OUTSIDE DIAMETER FIRST, THEN THE LARGER ONE.

- Insert the flanged nut.
- Prepare the torque wrench for LH locking using an industrial-type hexagonal socket wrench.
- Tighten the driven pulley shaft fixing nut using an offset wrench.



NOTE

DUE TO THE HIGH TIGHTENING TORQUE, USING DIFFERENT WRENCHES (TRADITIONAL MULTI-POINT SOCKET WRENCH) MAY DAMAGE THE HEXAGON LOCATED ON THE SHAFT OR BREAK THE BUSHING.

Locking torques (N*m)

Driven pulley nut 92 - 100

- Fit the driven pulley shaft cover, fitting the tooth gap in the lower part matching the reference mark on the transmission crankcase.



NOTE

CHECK THAT THE AIR INTAKE AND OUTLETS ARE COMPLETELY FREE.

-
- Fit the plastic external transmission cover.
 - Tighten the 4 fixing screws to the prescribed torque.

Locking torques (N*m)**External transmission cover screws 7 ÷ 9**

End gear

Removing the hub cover

- Drain the rear hub oil through the oil drainage plug located under the engine.
- Remove the 7 fixing screws. Remove the hub cover and the relevant gasket.



Removing the wheel axle

- Remove the transmission shaft.
- Remove the wheel axle with gear.



Removing the hub bearings

- Check all bearings for correct conditions (wear, clearance and noise).

If any fault is detected, proceed as follows.

To remove the wheel axle bearing on the engine crankcase, use the following parts.

Specific tooling

001467Y014 Pliers to extract Ø 15-mm bearings

001467Y034 Pliers to extract Ø 15-mm bearings

001467Y031 Driver



- Use the appropriate extractor to remove the bearing on the engine crankcase of the transmission shaft.

Specific tooling

001467Y006 Pliers to extract 20-mm bearings

001467Y035 Driver for bearings with OD 47 mm

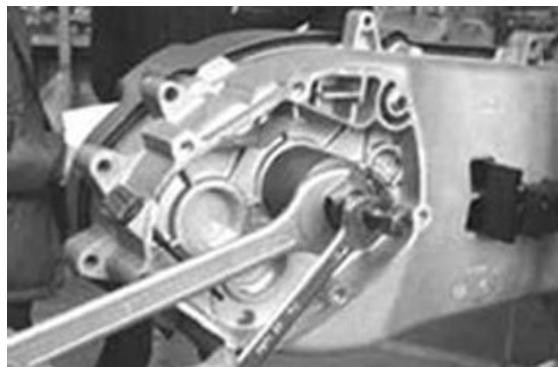

- Support the hub cover using the stud bolt set.
- Extract the bearing with the specific tool.

Specific tooling

020476Y Stud bolt set

001467Y006 Pliers to extract 20-mm bearings

001467Y007 Driver for bearings with OD 54 mm



Removing the wheel axle bearings

- Remove the Seeger ring from the outside of the hub cover.



-
- Support the hub cover using the stud bolt set.
 - Extract the bearing with the specific tool.

Specific tooling

020476Y Stud bolt set

020376Y Adaptor handle

020477Y 37-mm adaptor

020483Y 30-mm guide

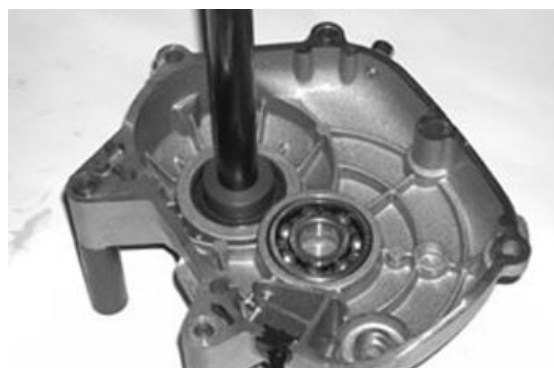

-
- Remove the oil seal using a screwdriver.



Removing the driven pulley shaft bearing

- Should the driven pulley shaft, its bearing and oil seal be removed, take out the transmission cover and the clutch assembly as described in the «Automatic transmission» chapter.
- Extract the driven pulley shaft from its bearing.
- Remove the oil seal using a screwdriver inside the hub gearcase.
- Remove the Seeger ring shown in the figure.



- Remove the driven pulley shaft bearing from the engine crankcase using a specific tool.

Specific tooling

020376Y Adaptor handle

020358Y 37 x 40 mm adaptor

020364Y 25-mm guide

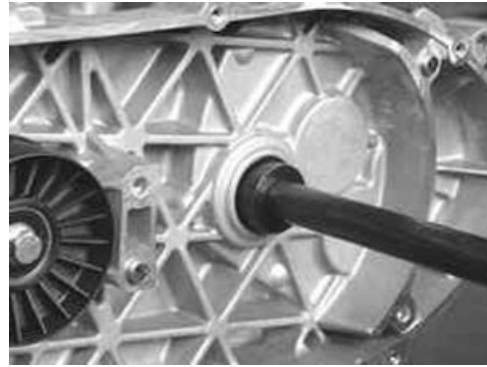

Inspecting the hub shaft

- Check the 3 shafts for wear or distortions on the toothed surfaces, on the bearing housings and the oil seals.
- If faults are found, replace the damaged parts.

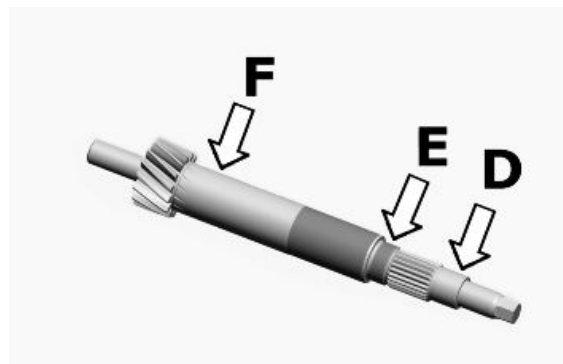
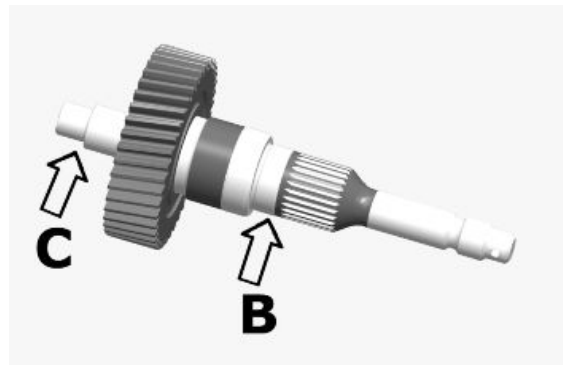
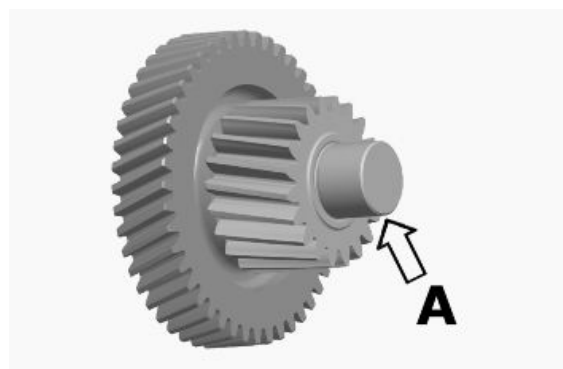

Characteristic

Bearing diameter for transmission shaft:

A = $\varnothing 20 - 0.01 - 0.02$ mm

Bearing diameter for wheel axle:

B = Ø 30 - 0.010 -0.023 mm

C = Ø 15 - 0.01 -0.02 mm

Bearing diameter for driven pulley shaft:

D = Ø 17 - 0.01 -0.02 mm

E = Ø 20 - 0.01 -0.02 mm

F = Ø 25 - 0.01 -0.02 mm

Inspecting the hub cover

- Check that the coupling surface is not dented or distorted.
- Check the bearing capacity.

If faults are found, replace the hub cover.

Refitting the driven pulley shaft bearing

- Heat the crankcase with an air heater.

Specific tooling

020151Y Air heater

020150Y Air heater support



- Using the specific tool fit the driven pulley shaft bearing until it stops against the bottom of the seat.

NOTE

PLACE IT WITH THE BALLS FACING THE HUB SIDE (THIS APPLIES TO BEARINGS WITH PLASTIC CAGE).

Specific tooling

020376Y Adaptor handle

020360Y 52 x 55 mm adaptor

020364Y 25-mm guide



- Heat the intermediate gear bearing seat.
- Fit the intermediate shaft bearing using the specific tool.

NOTE

PLACE IT WITH THE BALLS FACING THE HUB SIDE (THIS APPLIES TO BEARINGS WITH PLASTIC CAGE).

Specific tooling

020376Y Adaptor handle

020359Y 42 x 47 mm adaptor

020363Y 20-mm Oil seal guide

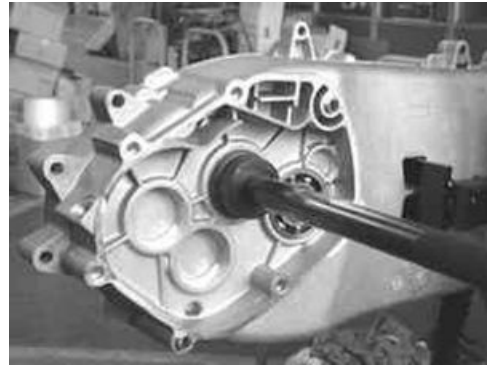

- Heat the seat of the wheel axle bearing on the crankcase.
- Fit the wheel axle bearing in the upper crankcase seat using the specific tool.

NOTE

PLACE IT WITH THE BALLS FACING THE HUB SIDE (THIS APPLIES TO BEARINGS WITH PLASTIC CAGE).

Specific tooling

020376Y Adaptor handle

020359Y 42 x 47 mm adaptor

020412Y 15-mm guide



- Place the safety Seeger ring locking the driven pulley shaft bearing.

NOTE

PLACE IT IN THE POSITION SHOWN IN THE FIGURE.



- Fit the pulley shaft oil seal on the transmission side.



- Heat the crankcase with an air heater.

Specific tooling

020151Y Air heater

020150Y Air heater support



- Using the specific tool fit the driven pulley shaft bearing until it stops against the bottom of the seat.

NOTE

PLACE IT WITH THE BALLS FACING THE HUB SIDE (THIS APPLIES TO BEARINGS WITH PLASTIC CAGE).

Specific tooling

020376Y Adaptor handle

020360Y 52 x 55 mm adaptor

020364Y 25-mm guide



- Heat the intermediate gear bearing seat.
- Fit the intermediate shaft bearing using the specific tool.

NOTE

PLACE IT WITH THE BALLS FACING THE HUB SIDE (THIS APPLIES TO BEARINGS WITH PLASTIC CAGE).

Specific tooling

020376Y Adaptor handle

020359Y 42 x 47 mm adaptor

020363Y 20-mm Oil seal guide



- Heat the seat of the wheel axle bearing on the crankcase.
- Fit the wheel axle bearing in the upper crankcase seat using the specific tool.

NOTE

PLACE IT WITH THE BALLS FACING THE HUB SIDE (THIS APPLIES TO BEARINGS WITH PLASTIC CAGE).

Specific tooling

020376Y Adaptor handle



020359Y 42 x 47 mm adaptor

020412Y 15-mm guide

- Place the safety Seeger ring locking the driven pulley shaft bearing.

NOTE

PLACE IT IN THE POSITION SHOWN IN THE FIGURE.



- Fit the pulley shaft oil seal on the transmission side.



Refitting the hub cover bearings

- Heat the bearing seats on the cover using the air heater.

- Support the hub cover using the stud bolt set.

Specific tooling

020151Y Air heater

020150Y Air heater support



- Fit the intermediate shaft bearing on the cover using the specific tool.

NOTE

PLACE IT WITH THE BALLS FACING THE HUB SIDE (THIS APPLIES TO BEARINGS WITH PLASTIC CAGE).

Specific tooling

020376Y Adaptor handle

020360Y 52 x 55 mm adaptor

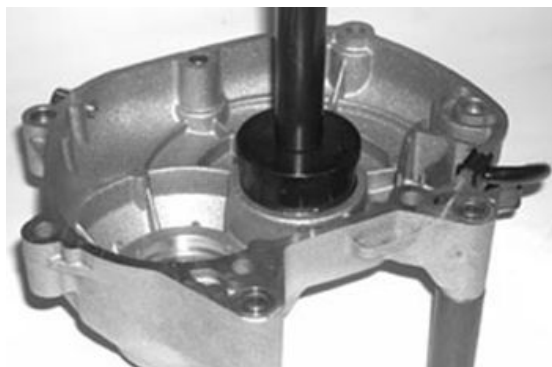

020363Y 20-mm Oil seal guide

- Heat the wheel axle bearing seat from the cover external side.
- Fit the wheel axle bearing on the cover until it stops using the specific punch.



Specific tooling

020376Y Adaptor handle

020360Y 52 x 55 mm adaptor

020483Y 30-mm guide

- Refit the circlip.



- Support the hub cover using the stud bolt set.
- Fit the wheel axle oil seal with the sealing lip facing the inside of the cover.
- Place the oil seal flush with the crankcase.



Specific tooling

020376Y Adaptor handle

020360Y 52 x 55 mm adaptor

020476Y Stud bolt set

Refitting the hub bearings

- Place the 3 shafts as shown in the figure.



Flywheel cover

- Remove the three clamps shown in the figure for an easy removal of the flywheel cover, remove the cylinder feed coupling and disconnect the return coupling from the pump cover

NOTE

THE CLAMPS MUST BE REPLACED. TO REMOVE THEM, OPEN OR CUT THEM USING A SCREWDRIVER. BE CAREFUL NOT TO DAMAGE THE PLASTIC UNIONS

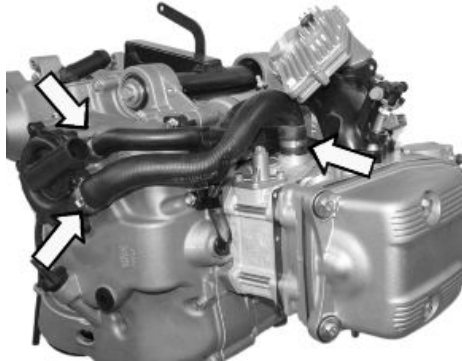

Removing the hub cover

- Drain the engine oil by removing the drainage plug.
- Prepare a suitable container to collect the oil.



- Remove the pre-filter.



- Remove the oil filter using either a strap-type or a cup-style oil filter wrench.



- Undo the 14 fixing screws.
- Remove the flywheel cover with the relevant gasket and the support of the cooling system sleeves.

NOTE

THE SCREWS COME IN 4 DIFFERENT LENGTHS, NOTE THEIR POSITIONS.

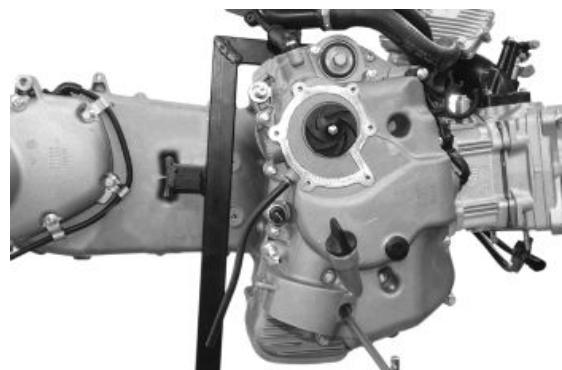

CAUTION

REMOVE THE COVER AVOIDING ANY POSSIBLE INTERFERENCE BETWEEN STATOR AND ROTOR.

CAUTION

BE CAREFUL NOT TO DROP THE BY-PASS VALVE AND THE RELEVANT SPRING.

Removing the flywheel cover components

- Undo the 6 fixing screws and remove the water pump cover.

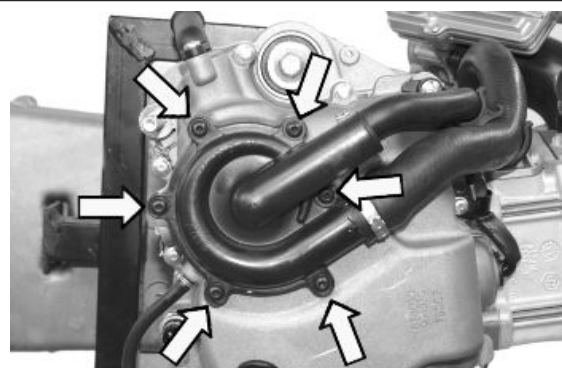

- Remove the by-pass and the relevant spring.
- Remove the sealing gasket.



Removing the stator

- Remove the 2 fixing screws and the cable harness guide bracket.

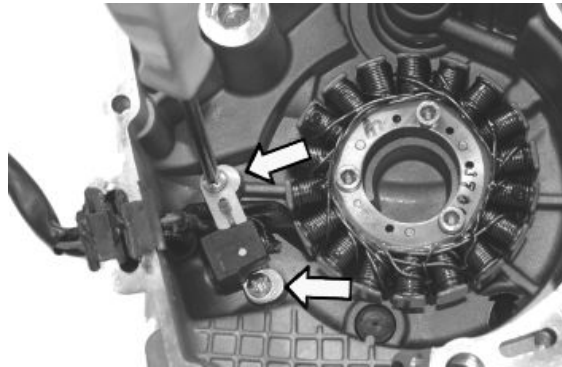

- Undo the 3 fixing screws and remove the stator with the cable harness.



Inspecting the cover components

- Undo the 2 fixing screws and remove the reed valve support with bulkhead.



- Remove the blow-by reed valve with the relevant sealing gasket.



- Undo the fixing screw and remove the gas outlet union with the relevant O-ring.



- Check that the crankcase coupling surface is not worn or distorted.
- Check that the by-pass valve seat, the torque limiter bearing and the water pump shaft bearing are not worn.



Characteristic

By-pass housing hole diameter:

13.9 mm

Bearing diameter for start-up gear shaft:

12 mm

Bearing diameter for pump shaft:

8 mm

- Check that the coupling surface and the oil filter union are not worn or deformed.

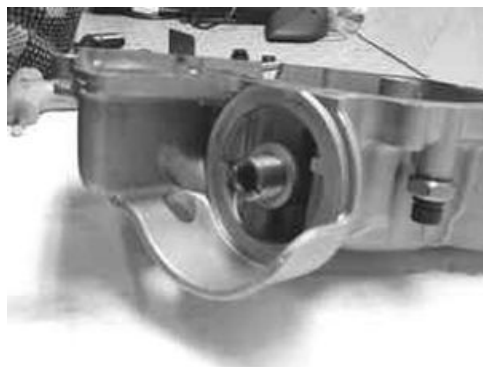

- Check the condition of the stator and of the relevant cable harness.



- Check the continuity between the 3 phases.

NOTE

THE VALUES ARE STATED AT AMBIENT TEMPERATURE. A CHECK WITH THE STATOR AT OPERATING TEMPERATURE MAY RESULT IN VALUES HIGHER THAN THOSE STATED.

Electric characteristic**Resistance:**

0.2 ÷ 1 Ω



- Check the earth insulation of each phase.
- If faults are found, check the cable thoroughly as it consists of two types of cables: rigid cables close to the stator and flexible cables close to the connector.



- Check that the winding is placed so as not to interfere with the heads of the fixing screws.

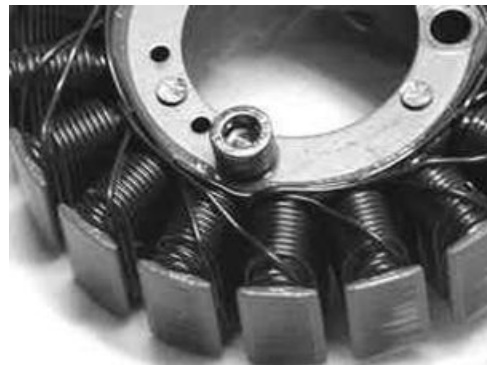

Refitting the stator

- Fit the stator together with the cable harness, fixing the 3 screws to the prescribed torque.

NOTE

INSERT THE SEALING GASKET OF THE RUBBER WIRING INTO THE SPECIFIC SEAT ON THE CRANKCASE.

Locking torques (N*m)

Stator clamps 8 - 10



- Fit the guide bracket with the cable harness, fixing the 2 screws to the prescribed torque.

Locking torques (N*m)

Stator cable harness guide bracket screws 3 - 4

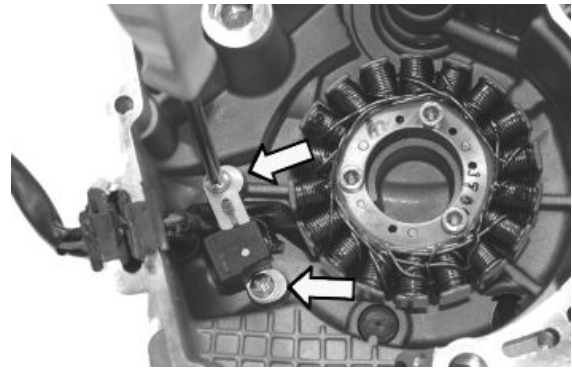

Refitting the flywheel cover components

- Before refitting, check that all components are perfectly clean.
- For the cover housing, carefully check all lubrication channels, especially:
- The 3 by-pass channels.



- Oil pressure sensor feeding duct.



- Oil vapour decantation chamber drainage.



- Temporarily fit the plug for the distribution timing check hole and the engine oil filler cap/dipstick.
- Fit the blow-by recovery duct using a new O-ring.
- Tighten the screw to the prescribed torque.

Locking torques (N*m)

Blow-by scavenge duct fixing screws 3 - 4



- Fit the spring and the by-pass piston on the fly-wheel cover.

NOTE

LUBRICATE THE BY-PASS VALVE.



- Refit the blow-by reed valve and use a new sealing gasket.
- Refit the support with bulkhead by tightening the screws to the prescribed torque.

Locking torques (N*m)

Supporting screws with bulkhead 0.3 ÷ 0.4



- Place a new O-ring with caution so that it does not come into contact with any grease or oil.

FAILURE TO OBSERVE THIS RULE CAN IRRETRIEVABLY DEFORM THE O-RING.



- Before refitting, check that all components are perfectly clean.
- For the cover housing, carefully check all lubrication channels, especially:
 - The 3 by-pass channels.

- Temporarily fit the plug for the distribution timing check hole and the engine oil filler cap/dipstick.
- Fit the blow-by recovery duct using a new O-ring.
- Tighten the screw to the prescribed torque.



Locking torques (N*m)

Blow-by scavenge duct fixing screws 3 - 4

- Fit the spring and the by-pass piston on the fly-wheel cover.

NOTE

LUBRICATE THE BY-PASS VALVE.



- Oil pressure sensor feeding duct.



- Oil vapour decantation chamber drainage.

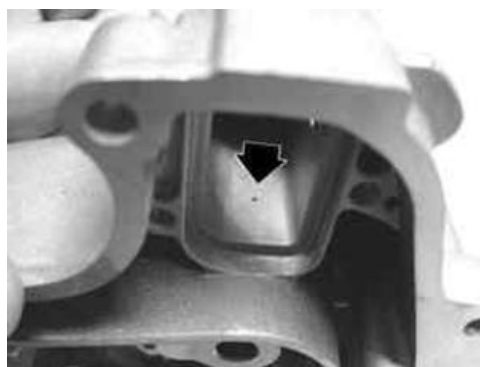

- Refit the blow-by reed valve and use a new sealing gasket.
- Refit the support with bulkhead by tightening the screws to the prescribed torque.

Locking torques (N*m)

Supporting screws with bulkhead 0.3 ÷ 0.4



Refitting the flywheel cover

- Fit a new oil filter, lubricate the sealing gasket, draw it close and finally tighten to the prescribed torque.

Locking torques (N*m)

Engine oil filter 12 ÷ 16



- Fit the feed coupling to the cylinder and connect the return coupling to the pump cover using 3 new clamps.

NOTE

TIGHTEN THE CLAMPS USING APPROPRIATE PLIERS, PAY ATTENTION NOT TO MARK COUPLINGS AND BE CAREFUL TO TIGHTEN THE CLAMPS WELL ENOUGH.

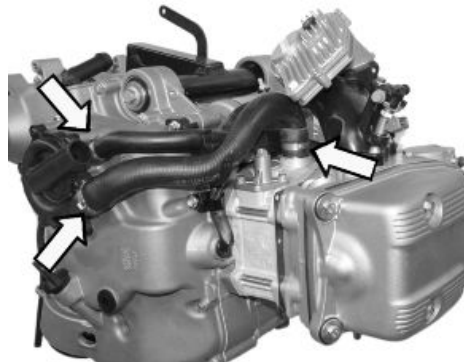

- Refit the pre-filter and the engine oil drainage plug; tighten the plug to the prescribed torque.
- Refill the engine with the prescribed type of oil.

Recommended products

AGIP CITY HI TEC 4T Engine oil

SAE 5W-40, API SL, ACEA A3, JASO MA Synthetic oil

Locking torques (N*m)

Engine oil drainage plug 24 ÷ 30



- Lubricate the seat of the intermediate gear with the torque limiter on the flywheel cover.
- Align the water pump drive with a reference and fit the flywheel cover as described in the Flywheel cover chapter.



- Fit a new gasket on the engine crankcase.
- Check that there are 3 centring dowels.



- Turn the crankshaft in order to align the counter-shaft drive with a reference mark on the crankcase (see figure).



- Repeat the alignment for the water pump shaft using the same reference mark on the cover.

NOTE

THIS ARRANGEMENT IS USEFUL, ESPECIALLY FOR OPERATIONS WITH THE WATER PUMP COVER FITTED.



- Fit the flywheel cover on the engine, paying attention to avoid interference between the stator and rotor.

WARNING

FAILURE TO OBSERVE THIS RULE MAY RESULT IN BROKEN CERAMIC MAGNETS.

- Fix the 14 cover fixing screws and tighten them to the prescribed torque.

NOTE

THE SCREWS COME IN FOUR DIFFERENT LENGTHS:

- THE 3 SHORTEST ARE FITTED AS SHOWN IN THE FIGURE.
- THE LONGEST IS FITTED UNDER THE ENGINE OIL FILLER PLUG.

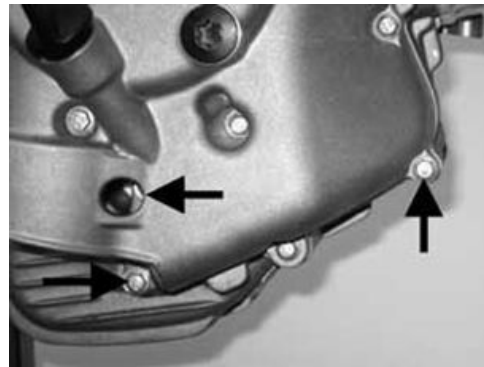
**NOTE**

- THE INTERMEDIATE SCREWS FOR THE REMAINING CLAMPS, EXCEPT THE COUPLING SUPPORT FIXING SCREW (SHOWN IN THE FIGURE), SLIGHTLY LONGER.

Locking torques (N*m)

Flywheel cover screws 11 - 13



Flywheel and starting

- Remove the three clamps shown in the figure for an easy removal of the flywheel cover, remove the cylinder feed coupling and disconnect the return coupling from the pump cover

NOTE

THE CLAMPS MUST BE REPLACED. TO REMOVE THEM, OPEN OR CUT THEM USING A SCREWDRIVER. BE CAREFUL NOT TO DAMAGE THE PLASTIC UNIONS

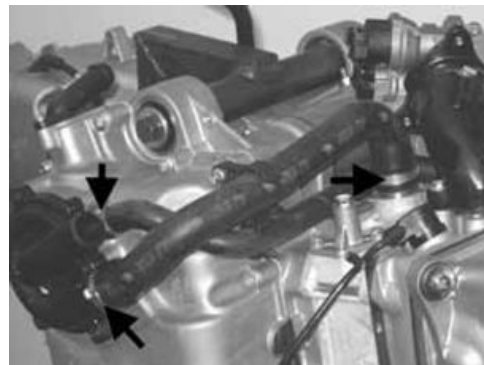

The starter motor is sold as a complete part.

Before deciding on its replacement, it is necessary to carry out the following checks:

1 - Battery

Check the voltage after not running (a few hours):

Voltage > 12.5 V

Check the density of the electrolyte of each cell:

Bé = 30 ÷ 32

Specific weight: 1.25 ÷ 1.26

YES go to point 2 No go to point 3



2 - Check the correct connection of the negative terminals (battery negative and starter motor negative), between them and to the chassis.

YES go to point 4 NO go to point 5

3 - Recharge and, if necessary, replace the battery.

4 - Connect the diagnostic tester (see the «injection» chapter).

Connect the induction clamp of an ammeter to the starter motor power supply positive cable.

Remove the 10A fuse No. 12 (see the «fuses» chapter).

Switch «ON» with the switch set in the «RUN» position and the side stand up.

Select the «PARAMETERS» function.

Command to start the engine (so that it cannot move) long enough to measure the rpm and starter motor input.

NOTE

THE DECLARED RPM VALUE IS THAT INDICATED BY THE DIAGNOSTIC TESTER, THE RPM READING IS NOT THE REAL ONE, BUT IT IS VALID FOR DIAGNOSIS PURPOSES.

Specific tooling

AP8140595 Axone + battery charger (230V 50Hz)

AP8202311 Axone + battery charger (110V 60Hz)

Electric characteristic

Input at driving speed:

80÷ 120 A

Engine speed

~300 ÷ 400 rpm

YES go to point 6 NO go to point 7 NO go to point

8 NO go to point 9



5 - Restore the connections

6 - **The values are correct.**

Finally carry out a check of the current absorption at idle speed.

Remove the starter motor (see the flywheel and start-up system chapter).

Reconnect the ground lead and the positive and check.

Electric characteristic

Current absorption at idle speed:

< 40 A

YES go to point 10 NO go to point 11

7 - Low driving speed

High electrical absorption

Check for engine rotation (example: possible bushing jamming) and if no faults are detected, replace the starter motor.

8 - Low driving speed

Low electrical absorption

Repeat the test, bridging the power terminals of the start-up remote control switch or rather replacing them.

Check the new values.

YES go to Point 12 NO go to point 13

9 - High driving speed

Low electrical absorption

The engine turns too freely, check the end of compression pressure.

If the values are not correct, proceed as follows.

10 - The motor works properly.

11 - Check the armature rotation.

12 - Finally replace the start-up remote control switch.

13 - Check the battery again and, if necessary, replace the starter motor.

NOTE

IF THE CRANKSHAFT DRIVING SPEED IS LOW AND THERE IS STRANGE NOISE, CHECK THE FREEWHEEL AND THE TORQUE LIMITER (SEE THE «MAGNETO FLYWHEEL AND STARTER SYSTEM» CHAPTER).

STARTER MOTOR

Specification	Desc./Quantity
Type	Mitsuba sm13d
Power	0.9 kW

BATTERY

Specification	Desc./Quantity
Capacity	14 Ah
Pick-up current	125 A

START-UP REMOTE CONTROL SWITCH

Specification	Desc./Quantity
Type	SEALED
Capacity	150 A, continuous

START-UP TRANSMISSION

Specification	Desc./Quantity
Ring gear and freewheel coaxial to the flywheel.	Intermediate gear integrated with the torque limiter.

The start-up system has a gear between the motor armature and the crankshaft that is equipped with a freewheel coaxial to the flywheel and the torque limiter on the intermediate shaft.

The torque limiter is calibrated at 10 kgm (100 Nm); this component protects the structure of the engine and the start-up kinematic mechanism in the event of incorrect start-up procedure, resulting in inverse rotation.

The freewheel is used for a sufficiently silent start-up.

The start-up control (energised remote control) is slaved to enabling signals by the side stand and the emergency OFF/RUN switch, which does not allow starting given dangerous conditions.

The start-up control circuit is not controlled by the immobiliser system; therefore, before insisting on the starter system in an abnormal way, check the immobiliser enabling switch.

To check the enabling switch circuit, see the «Electrical system» chapter; to check the crankshaft control transmission, follow what is described in the «Flywheel and start-up system» chapter.

Removing the starter motor

NOTE

THIS OPERATION MAY ALSO BE CARRIED OUT WITH THE FLYWHEEL COVER FITTED.

- Undo the two fixing screws.
- Slide off the complete starter motor.



Removing the flywheel magneto

NOTE

SHOULD THE MAGNETO FLYWHEEL BE REMOVED, FIRST REMOVE THE CHAIN GUIDE SLIDER RETENTION PLATE.

- Unscrew the 3 fixing screws and remove the chain guide slider retention plate and the starting ring gear.

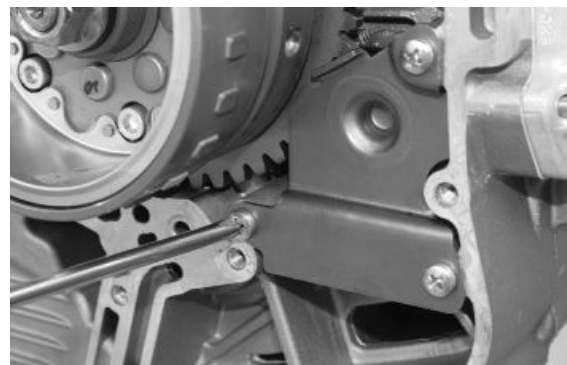

-
- Align the two holes on the flywheel with the seat on the crankcase so that the specific tool can be placed.

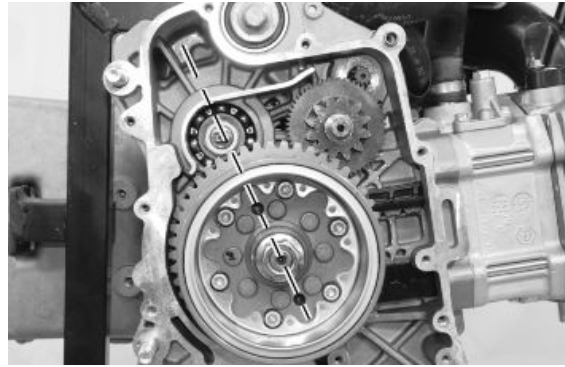

-
- Tighten the bushing which is part of the flywheel locking tool on the extractor thread.



-
- Fit the specific tool as shown in the figure, making sure that the pins are perfectly inserted into the previously aligned holes and that they are fitted fully to the end and almost flush with the flywheel.

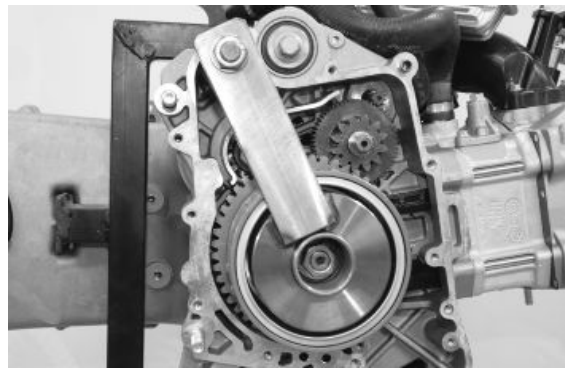

Specific tooling

020472Y Flywheel lock wrench

-
- Unscrew the magneto flywheel fixing nut.
 - Remove the specific tool and the fixing nut.



- Remove the washer.



- Insert the nut again so as to slightly uncover the shaft and free the space previously occupied by the washer.

CAUTION

THIS OPERATION IS REQUIRED AS THE FLY-WHEEL IS STRONGLY LOCKED; IF THE CONE GETS DETACHED, THIS MAY CAUSE THE ROTOR TO FALL, AND CONSEQUENTLY THE MAGNETS MAY BREAK.



- Fit the specific extractor.
- Using a 27-mm wrench and a 19-mm bushing, release the flywheel.

Specific tooling

020467Y Flywheel extractor



- Remove the extractor.
- Remove the nut and slide off the magneto fly-wheel with the starting ring gear.
- Remove the key from the crankshaft.



-
- To remove the starting ring gear from the free-wheel, turn it clockwise and slide off.



-
- Remove the freewheel from the magneto fly-wheel by undoing the 6 fixing screws.

SHOULD THE FREEWHEEL NEED TO BE REMOVED, IT IS ADVISABLE TO LOOSEN THE 6 FIXING SCREWS IN ADVANCE, WITH THE FLY-WHEEL STILL FITTED ON THE CRANKSHAFT.



-
- The freewheel is coupled to the flywheel with high precision; if removal is difficult, use 2 screws as gripping points and as extractors, if required.



-
- Slide off the intermediate gear provided with torque limiter.

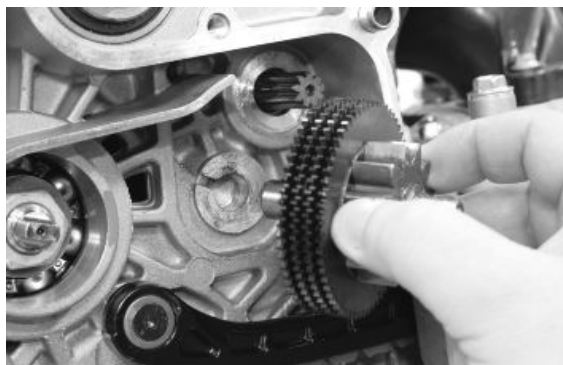

Inspecting the flywheel components

- Check that the magnets are in good conditions.
- Check that the magnet support cage is not deformed or broken.



Starter gear rim

- Check that there is no wear or abnormal marks on the «rollers» of the freewheel and on the surface of the starter ring gear hub.
- Check the hub outside diameter.

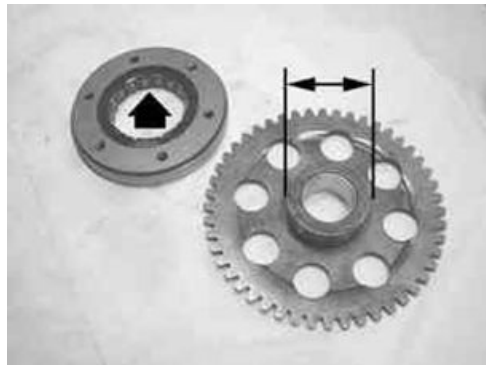

Characteristic

Hub outside diameter

45.665 mm (+0.008; +0.005) mm (1.79 in
+0.0003; + 0.0002) in)

- Check the inside diameter of the start-up gear bushing.
- Check that the tothing is not worn.



Characteristic

Bushing inside diameter

27 mm (+0.020; +0.041) mm (1.0629 in (+0.0008;
0.0016) in)

NOTE

IF THE FAULTS FOUND AFFECT THE HUB, IT IS EXPEDIENT TO REPLACE THE STARTING RING GEAR AND THE FREEWHEEL.

IF ONLY THE BUSHING IS WORN, REPLACE ONLY THE COMPLETE STARTING RING GEAR. ALSO CHECK THE DIAMETER AND THE SURFACE OF THE BEARING ON THE CRANKSHAFT. IN CASE OF IRREGULARITIES, REPLACE THE CRANKSHAFT.

Intermediate gear

- Check that the tothing is not worn.
- Check the diameter of the two bearings.

Characteristic

Gear bearing diameter

12 (0; - 0.011) mm (0.47000 (0; -0.00043) in)

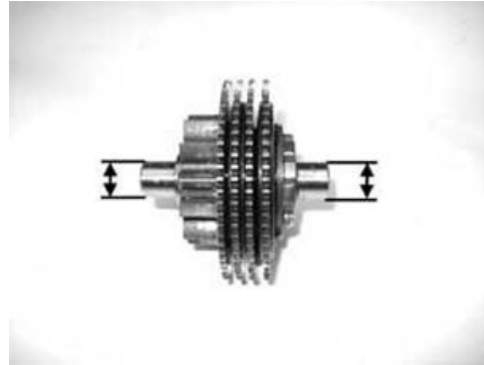

Also check the diameter of the bearings on the flywheel cover and on the engine crankcase.

Characteristic

Diameter of bearing on the flywheel cover

12 (+0.034; - 0.016) mm (0.47000 (+0.0013; -0.0006) in)

Diameter of bearing on the engine crankcase

12 (+0.034; - 0.016) mm (0.47000 (+0.0013; -0.0006) in)

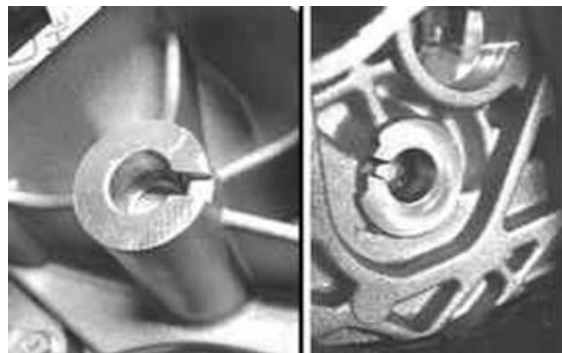

NOTE

THE TORQUE LIMITER IS EQUIPPED WITH 4 GEARS THAT FUNCTION AS CLUTCH DRIVING PLATES.

Driven plates consist of 4 Belleville springs with grooved profiles; this assembly allows transmitting torques lower than 10 kgm.

In case of incorrect start-up procedures, the torque limiter prevents any kicks, resulting in inversion of rotation direction of the crankshaft, which would impair the engine structure.



The limiter assembly cannot be overhauled. In case of clearly visible irregularities on the toothed discs, replace the assembly.

Refitting the free wheel

- Make sure the freewheel faying surfaces are in good condition.
- Thoroughly clean the freewheel to remove any LOCTITE left.
- Degrease the threading of the freewheel holes and the fixing screws.
- Apply the recommended product to the end of the screws.

Recommended products**Loctite 243 Medium strength threadlock**

-

- Fit the freewheel on the magneto flywheel, making sure that the ground side is in contact with the flywheel, that is the wheel Seeger ring should be visible.

- Tighten the 6 fixing screws in a criss-cross sequence to the prescribed torque.



- Lubricate the freewheel «rollers».

**Refitting the intermediate gear**

- Grease the gear housing on the engine crankcase.



-
- Fit the intermediate gear with torque limiter.



-
- Lubricate the internal bushing and the starter ring gear hub surface.



-
- Fit the starting ring gear on the flywheel by turning it clockwise and inserting the gear at the same time.



Refitting the flywheel magneto

-
- Insert the key on the crankshaft.
 - Fit the magneto flywheel checking the proper insertion of the key and engaging the torque limiter gear with the starting ring gear.



- Fit the washer and the nut on the crankshaft.



- Tighten the guide bushing which is part of the flywheel locking tool as far as it will go and then loosen it 1/4 of a turn.

NOTE

FAILURE TO OBSERVE THIS RULE CAUSES THE GUIDE ON THE FLYWHEEL TO GET LOCKED.

Specific tooling

020472Y Flywheel lock wrench



- Align the 2 holes of the magneto flywheel with the seat on the crankcase to fit the specific tool.

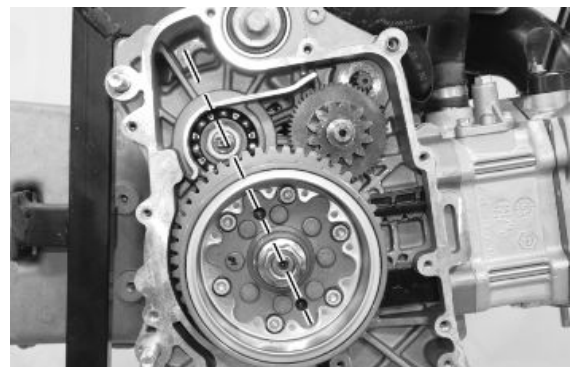

- Fit the specific tool checking that the pins are perfectly inserted into their positions.

Specific tooling

020472Y Flywheel lock wrench

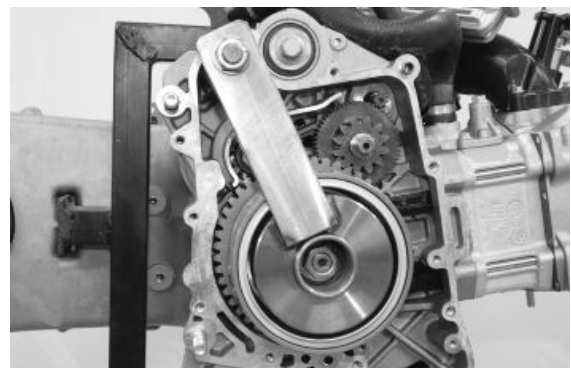

-
- Tighten the flywheel lock nut to the prescribed torque.

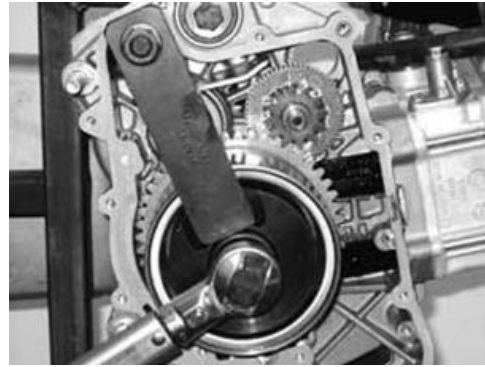
Locking torques (N*m)**Flywheel fixing nut 115 - 125**

-
- Fit the chain guide slider retention plate by tightening the 3 screws to the prescribed torque.

NOTE

BEFORE TIGHTENING THE SCREWS, MOVE THE STARTING RING GEAR UNTIL IT MAKES CONTACT WITH THE CRANKCASE AND CHECK THAT IT IS FREE TO ROTATE ANTI-CLOCKWISE.

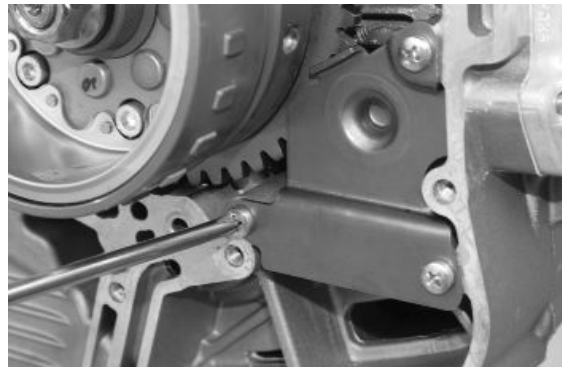
Locking torques (N*m)**Chain guide slider plate fixing screws 3 ÷ 4**

Refitting the starter motor

- Check that the O-ring is in good conditions and lubricate it.
- Fit the starter motor.
- Tighten the 2 fixing screws to the prescribed torque.

Locking torques (N*m)**Starter motor screws 11 ÷ 13**

Cylinder assy. and timing system

- Remove the external and internal transmission covers.



-
- Remove the flywheel cover, the flywheel and the torque limiter.

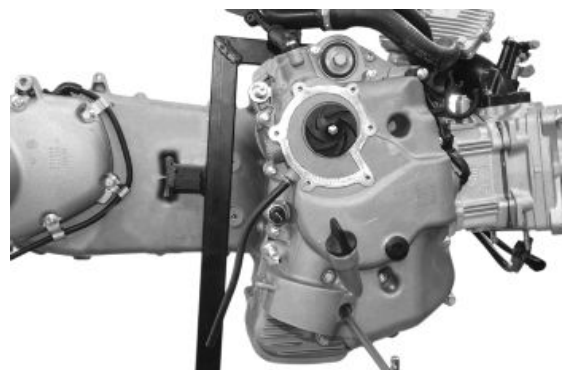

Removing the intake manifold

- Undo the 3 fixing screws.
- Remove the complete inlet manifold unit.



Removing the rocker-arms cover

- Undo the 6 special screws with stop and the relevant rubber gaskets.
- Remove the tappet cover with the relevant gasket.

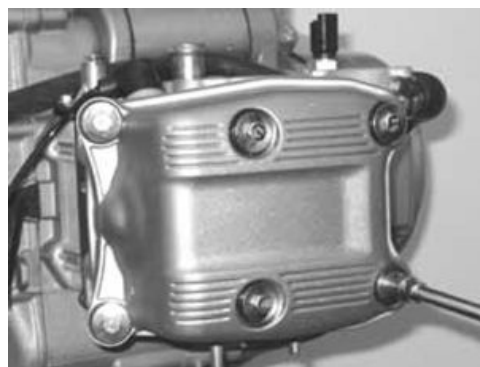

Removing the timing system drive

- Turn the engine until the intake valves are closed.



- Remove the central screw and the valve-lifter mass retaining cover using the specific tool.

Specific tooling

AP8106702 Flywheel lock calliper spanner

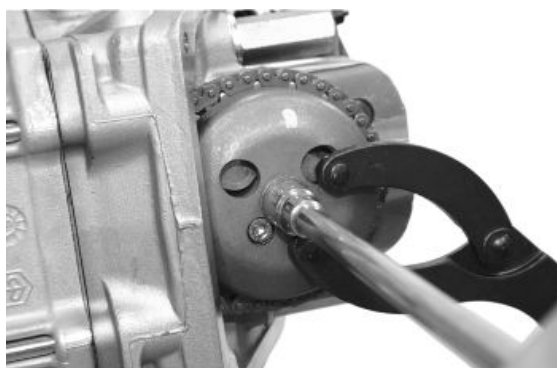

- Remove the return spring and the valve-lifter mass with relevant end of stroke washer.

NOTE

BE CAREFUL SO THAT THE SPRING AND THE WASHER DO NOT FALL INTO THE ENGINE THROUGH THE CHAIN COMPARTMENT.

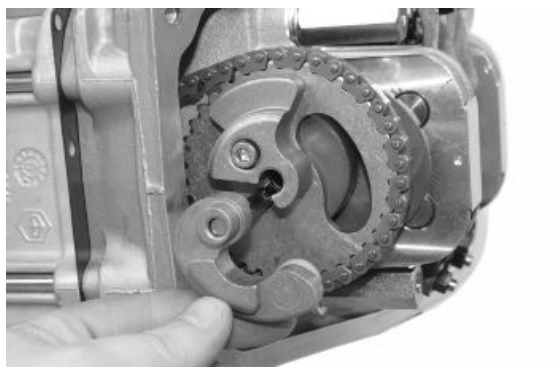

- Align the reference marks located on the timing chain gear and on the head.



- Loosen the central screw on the tensioner first.
- Remove the 2 fixing screws and remove the tensioner with the relevant gasket.



Remove the internal hex screw and the counterweight as shown in the figure.

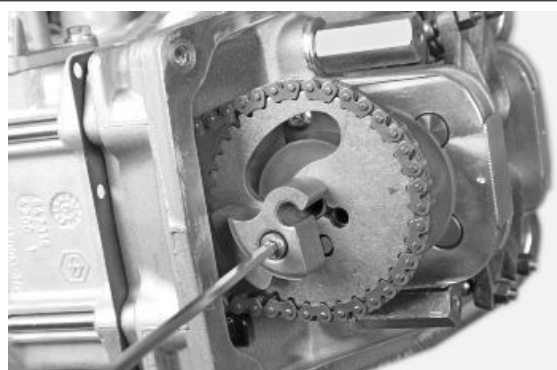

- Remove the timing chain gear from the camshaft.
- Remove the gear from the timing chain.

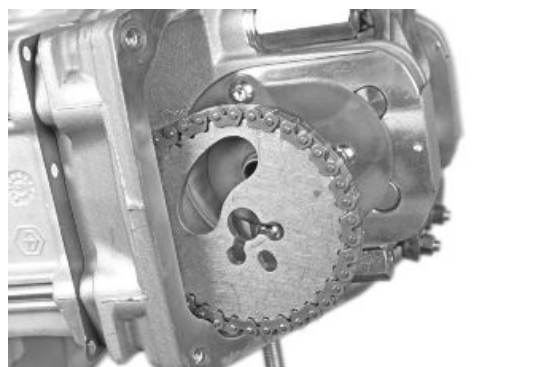

Removing the cam shaft

- Remove the 3 fixing screws and the camshaft retaining bracket.

NOTE

REMOVING THE FIXING SCREWS MAY BE DIFFICULT. BE CAREFUL NOT TO DAMAGE THE INTERNAL HEXAGON. IF NECESSARY, DETACH THE THREADS IN ADVANCE.

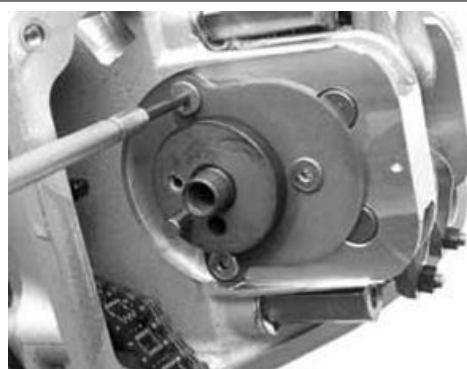

- Remove the camshaft.

CAUTION

THE TWO CAMSHAFTS ARE DIFFERENT ONE FROM THE OTHER. IT IS POSSIBLE TO IDENTIFY THEM BY LETTER "A" (FRONT) OR "P" (REAR) STAMPED ON THE EXTERNAL SHOULDER, CROWN GEAR SIDE.



- Remove the pins and the rocking levers acting from the transmission-side holes.

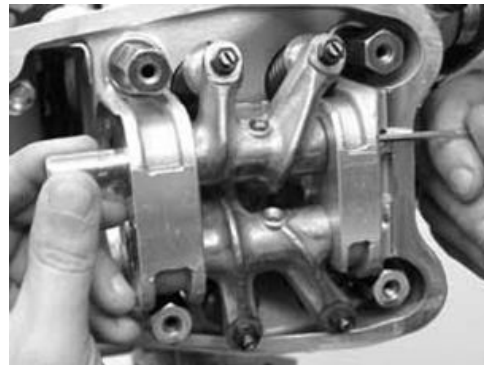

Removing the cylinder head

- Remove the spark plugs.
- Remove the cooling system outlet sleeve together with the thermostat.



- Remove the coolant temperature sensor.

NOTE

THE SENSOR CONTROLS BOTH THE INJECTION AND THE ANALOGUE INSTRUMENT ON THE INSTRUMENT PANEL. TO CHECK THIS COMPONENT, SEE THE INJECTION CHAPTER.



- Remove the 2 fixing nuts on the head, outlet and intake sides.

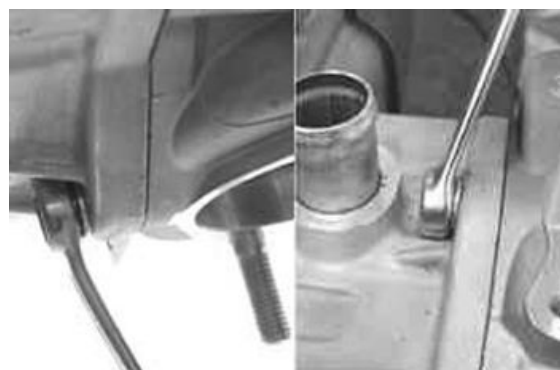

- Remove the two M6 side clamps inside the distribution channel and the M6 side clamp, spark-plug side, together with the thermostat support.

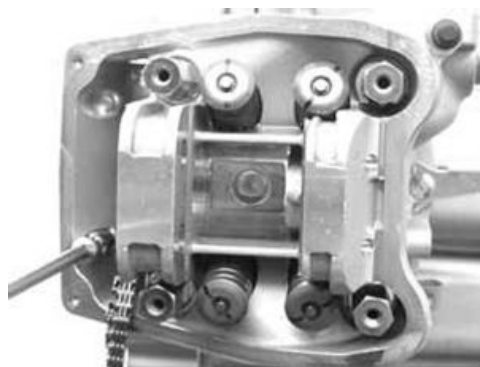

NOTE

IF NECESSARY, THE HEAD MAY BE REMOVED TOGETHER WITH THE CAMSHAFT, ROCKING LEVER PINS AND MOUNTING BRACKET.

- Loosen the 4 head-cylinder fixing nuts in two or three stages and in a criss-crossed sequence.
- Remove the head, the 2 centring dowels, the gasket and the lower chain guide slider.

NOTE

DO NOT REMOVE THE DOWELS IF THEY ARE FORCED-FITTED INTO THEIR SEATS.



CAUTION

UPON REMOVING THE HEAD, PREPARE A SUITABLE CONTAINER SINCE THE THERMAL GROUP CONTAINS COOLANT.

Removing the valves

- Using the appropriate tool fitted with an adapter, remove the cotter pins, plates, springs and valves.

Specific tooling

AP0276474 Valve spring compressor adaptor



CAUTION

ARRANGE THE VALVES SO AS TO RECOGNISE THEIR ORIGINAL POSITION ON THE HEAD (FLYWHEEL-SIDE AND TRANSMISSION-SIDE).

- Remove the oil seals with the specific tool.

Specific tooling

020431Y Valve oil seal extractor



- Remove the spring supports.

NOTE

BLOW THE SEATS WITH COMPRESSED AIR TO FACILITATE REMOVING THE SPRING SUPPORTS.



Removing the cylinder - piston assy.

- Remove the timing chain.
- Undo the fixing screw and remove the spacer and the tensioner slider.

NOTE

IT IS ADVISABLE TO MARK THE CHAIN IN ORDER TO ENSURE THAT THE INITIAL DIRECTION OF ROTATION IS MAINTAINED.

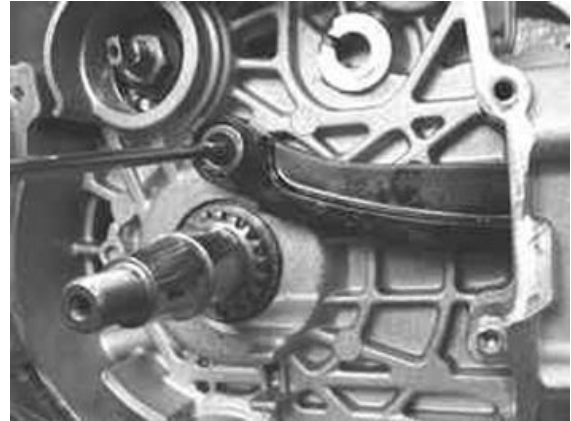

- Slide off the cylinder with the relevant gasket and the centring dowel.

NOTE

THE SECOND CENTRING IS ENSURED BY A DOWEL SET INTO THE CYLINDER.

CAUTION

TO AVOID DAMAGING THE PISTON, KEEP IT FIRM WHILE REMOVING THE CYLINDER.

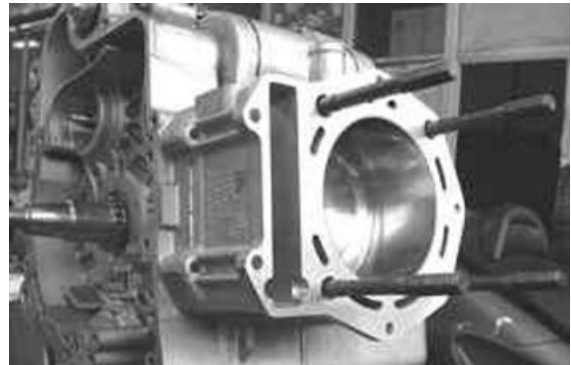

- Remove the 2 piston pin snap rings operating through the specific slots.
- Slide off the pin and remove the piston.

NOTE

USE PAPER OR A CLOTH TO CLOSE THE CYLINDER HOUSING MOUTH ON THE CRANKCASE TO PREVENT ONE OF THE TWO PIN SNAP RINGS FROM FALLING INSIDE.



- Remove the piston sealing rings and the scraper ring.

CAUTION

PAY ATTENTION TO THE FITTING POSITIONS OF THE RINGS TO PREVENT INVERTING THE POSITION IN CASE THEY ARE REUSED.

NOTE

BE CAREFUL NOT TO DAMAGE THE SEALING RINGS DURING REMOVAL.



Inspecting the small end

- Measure the inside diameter of the rod small end using a bore meter.

NOTE

IF THE ROD SMALL END DIAMETER EXCEEDS THE STANDARD DIAMETER, SHOWS SIGNS OF WEAR OR OVERHEATING, REPLACE THE CRANKSHAFT AS DESCRIBED IN THE «CRANKCASE AND CRANKSHAFT» CHAPTER.

Characteristic

Standard diameter:

22 + 0.025 +0.015 mm

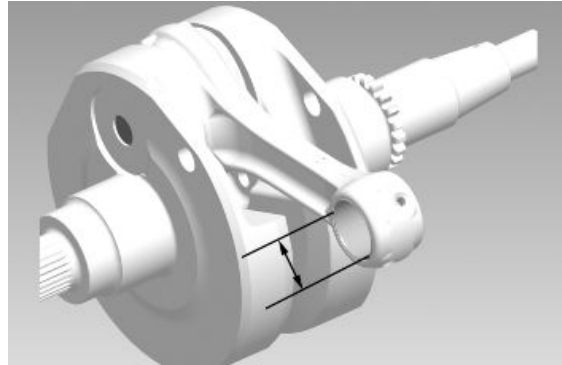

Inspecting the wrist pin

- Check the pin outside diameter using a micrometer.

Characteristic

Standard diameter:

22 -0.004 mm

- Calculate the rod small end - pin coupling clearance.

Characteristic

Standard clearance:

0.015 ÷ 0.029 mm

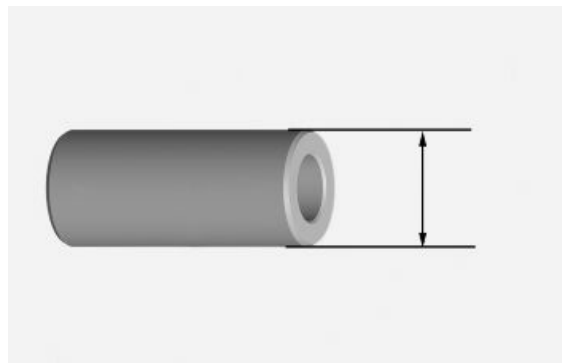

Inspecting the piston

- Measure the diameter of the bearings on the piston.

Characteristic

Standard diameter:

22 + 0.006 +0.001 mm

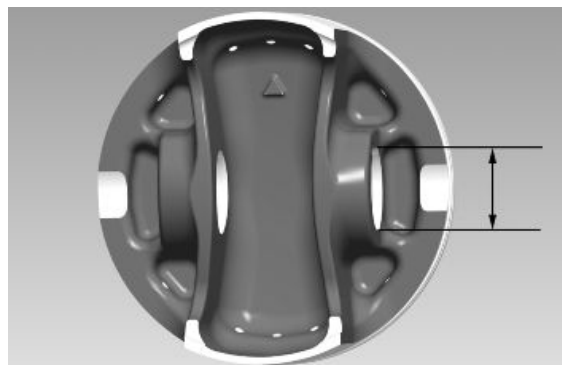

- Calculate the pin - piston coupling clearance.

NOTE

THE PIN HOUSINGS HAVE TWO LUBRICATION CHANNELS FOR THIS REASON MEASURE THE DIAMETER ACCORDING TO THE PISTON AXIS

Characteristic

Standard clearance:

0.001 ÷ 0.010 mm

- Measure the piston outside diameter, perpendicular to the pin axis.
- Carry out the measurement according to the position shown in the figure:

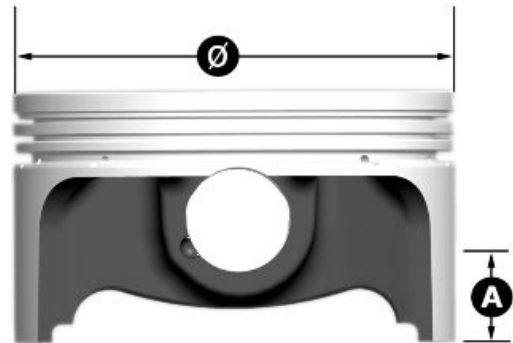

NOTE

TO MEASURE THE PISTON AND THE CYLINDER-PISTON COUPLING CLEARANCE REFER TO THE «SPECIFICATIONS» SECTION.

Characteristic

A:

10 mm

Piston diameter:

Nominal value: 94 mm

- Using a bore meter, measure the cylinder inside diameter according to the directions shown in the figure and at the prescribed height.

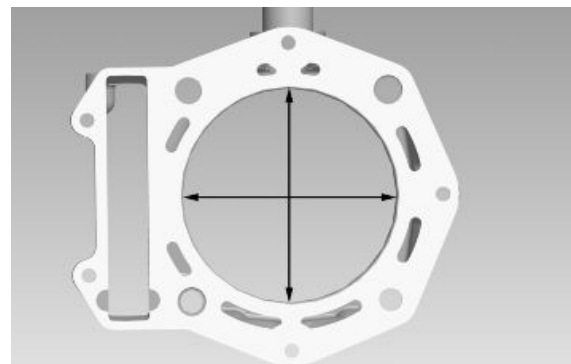

Characteristic

B:

43 mm

Standard diameter:

Nominal value: 94 mm

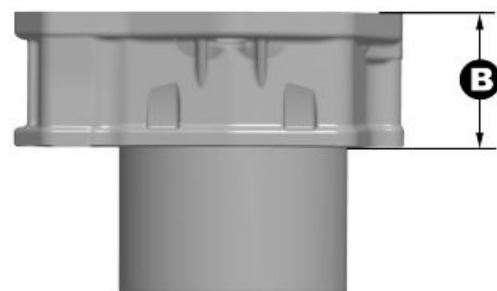

- Check that the coating is not peeled off.
- Check that the coupling surface with the head is not worn or distorted.

Characteristic

Maximum run-out allowed:

0.05 mm

- Pistons and cylinders are classified according to their diameter. This coupling is carried out in pairs (A-A, B-B, C-C, D-D).

NOTE

TO MEASURE THE CYLINDER AND THE CYLINDER-PISTON COUPLING CLEARANCE REFER TO THE «SPECIFICATIONS» SECTION.

Inspecting the piston rings

- Alternately fit the 3 sealing rings in the cylinder in the area where it keeps its original diameter. Using the piston, fit the rings perpendicularly to the cylinder axis.

- Check that each single sealing ring adheres uniformly to the cylinder liner. Otherwise, it means there is abnormal wear on the ring. Replace it if this occurs.

- Measure the opening of the sealing rings using a thickness gauge (see picture).

- Replace the piston rings if values higher than those prescribed are measured.



Check the size of the sealing ring opening:

Compression ring: $0.15 \div 0.35$ mm. Max. value: 0.5 mm

Oil scraper ring: $0.25 \div 0.50$ mm. Max. value: 0.65 mm

Oil scraper ring: $0.25 \div 0.50$ mm. Max. value: 0.65 mm

Rings/slots coupling clearances:

Carefully clean the sealing ring housings.

Check coupling clearances by placing a thickness gauge between the ring and the slot as shown in the figure.

Top ring: Standard coupling clearance:

$0.01 \div 0.06$ mm

Maximum clearances allowed after use: 0.10 mm

Middle ring: Standard coupling clearance:

$0.02 \div 0.07$ mm

Maximum clearances allowed after use: 0.10 mm

Oil scraper ring: Standard coupling clearance:

ance: $0.01 \div 0.06$ mm

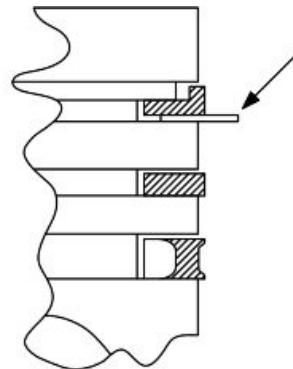

Maximum clearances allowed after use: 0.10

mm

If clearances measured exceed the maximum values specified in the table, the piston should be replaced with a new one.

Removing the piston

- Install piston and pin onto the connecting rod, with the piston arrow aligned facing the exhaust.



- Fit the pin snap ring in the specific tool, with the opening in the position indicated on the tool.

S = left

D = right



- Set the snap ring into its position with the punch.



- Fit the pin snap ring with the pin as shown in the figure.

Specific tooling

020470Y Pin snap ring fitting tool



NOTE

THE TOOL FOR INSTALLING THE STOP RINGS MUST BE USED MANUALLY.

CAUTION

USING A HAMMER MAY DAMAGE THE RINGS HOUSINGS.

Choosing the gasket

- First fit the piston into the cylinder, without any base gasket.
- Fit a dial gauge on the specific tool with the short union, as shown in the figure.

Specific tooling

020475Y Piston position checking tool

- With a contrasting surface, reset the dial gauge with a preloading of a few millimetres.
- Finally fix the dial gauge.
- Check the perfect sliding of the feeler pin.
- Fit the tool on the cylinder without changing the dial gauge position.
- Lock the tool with the original head fixing nuts.
- Rotate the crankshaft up to TDC (the reversal point of the dial gauge rotation).
- Measure the deviation from the reset value.

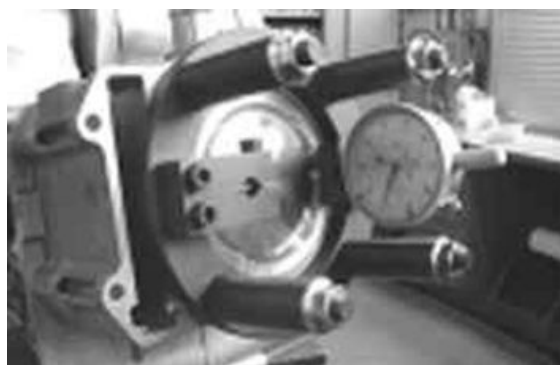

- Using the chart below, determine the thickness of the cylinder base gasket to be used upon refitting. By correctly determining the cylinder base gasket thickness, an adequate compression ratio can be maintained
- Remove the specific tool and the cylinder.

NOTE

IF DEVIATIONS (PROTRUSIONS OR RECESSES) CLOSE TO THE CHANGE OF CATEGORY ARE MEASURED, REPEAT THE MEASUREMENT AT THE OPPOSITE SIDE. TO DO SO, REPEAT THE TOOL FITTING OPERATION, INVERTING ITS POSITION.

Characteristic**Recess / Protrusion measured 1**

- 0.185 ÷ - 0.10

Gasket thickness 1

0.4 ± 0.05

Recess / Protrusion measured 2

- 0.10 ÷ + 0.10

Gasket thickness 2

0.6 ± 0.05

Recess / Protrusion measured 3

+ 0.10 ÷ + 0.185

Gasket thickness 3

0.8 ± 0.05

Refitting the piston rings

- Place the oil scraper ring spring on the piston.
- Fit the oil scraper ring keeping the gap opposed to the spring union and the word "top" facing the piston crown. In any case, the chamfered side of the must be facing the piston crown.
- Fit the middle piston ring with the identification letter or the word "top" facing the piston crown. In any case, the tapered side of the ring must be facing opposite the piston crown.
- Fit the top compression ring in the direction forced by the housing.
- It is advisable to use a fitter to help fitting the rings.

**NOTE**

THE 2 PISTON RINGS ARE MADE WITH A TAPERED CYLINDRICAL CONTACT SECTION. THIS IS TO OBTAIN A BETTER BEDDING.

- Offset the piston ring openings by 120° as shown in the figure.
 - Lubricate the components with engine oil.
 - The engine is fitted with a top ring with an L-shaped section.
-

Refitting the cylinder

- Fit the cylinder base gasket of the chosen thickness.
- With the fork support and the retaining clamp, fit the cylinder as shown in the figure.

NOTE

BEFORE FITTING THE CYLINDER, CAREFULLY BLOW AIR INTO THE LUBRICATION DUCT AND LUBRICATE THE CYLINDER LINER. CHECK THAT THERE ARE TWO REFERENCE DOWELS.



Specific tooling

020468Y Piston fitting ring

020512Y Piston fitting fork

Inspecting the cylinder head

- Using a trued bar and a thickness gauge, check that the cylinder head surface is not worn or distorted.

Characteristic

Maximum run-out allowed:

0.1 mm

- In case of irregularities, replace the head.
- Check the sealing surfaces for the inlet and exhaust manifold.
- Check that the camshaft and the rocker pin bearings show no signs of wear.
- Check that the head cover show no signs of wear.
- Check that the coolant sealing buffer is not rusted.



Inspecting the timing system components

- Check that the guide slider and the tensioner pad are not excessively worn.
- Check that the timing system gear unit controlling the camshaft and the crankshaft pinion is not worn.
- If signs of wear are found in the pads, replace them; if the chain, or sprocket are worn, replace the whole unit.



NOTE

IF THE CHAIN HAS DAMAGED THE PINION, REPLACE THE CRANKSHAFT AS DESCRIBED IN THE «CRANKCASE AND CRANKSHAFT» CHAPTER.

Chain tensioner:

- Remove the central screw with the washer and the tensioner spring.
- Check that the one-way mechanism is not worn.
- Check the condition of the tensioner spring.
- If signs of wear are found, replace the whole assembly.



Inspecting the valve sealings

- Visually inspect the valve sealing surface.

CAUTION

DO NOT CHANGE THE VALVE FITTING POSITION (RH - LH).

- Replace the valve with a new one if its sealing surface is damaged at one or more points or curved.



- Fit the valves into the cylinder head.
- Alternatively test the intake and outlet valves.
- The test should be carried out by filling the manifold with fuel and checking that the head does not ooze through the valves when they are just pressed by the fingers.



Inspecting the valve housings

- Remove any carbon deposits from the valve seats.
- Check the width of the mark on the valve seat «V» with Prussian blue.

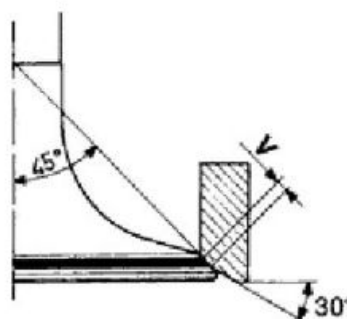

Characteristic

Standard value:

1 ± 1.3 mm

Limit allowed:

1.6 mm

- If the width of the mark on the valve seat is larger than the prescribed limits, true the seats with a 45° milling cutter and then grind.
- Replace the head in case of excessive wear or damage.

Inspecting the valves

- Measure the diameter of the valve stem at the three positions indicated in the diagram.

STANDARD DIAMETER

Specification	Desc./Quantity
Inlet:	4.987 ÷ 4.972 mm
Outlet:	4.975 ÷ 4.960 mm

MINIMUM DIAMETER ALLOWED

Specification	Desc./Quantity
Inlet:	4.96 mm
Outlet:	4.945 mm

- Calculate the clearance between the valve and its guide.

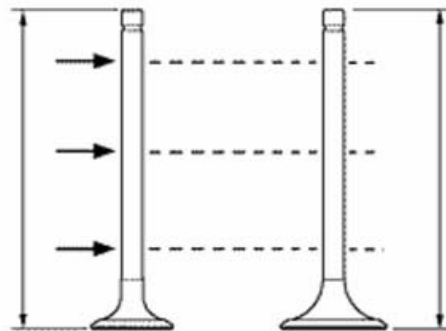

- Check the deviation of the valve stem by resting it on a « V »-shaped support and measuring the extent of the deformation using a dial gauge.

Characteristic

Limit value allowed:

0.1 mm

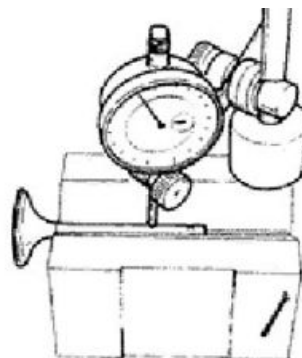

- Check the concentricity of the valve head by placing a dial gauge at a right angle with respect to the valve head and rotating it on the «V»-shaped support.

Characteristic

Limit allowed:

0.03 mm

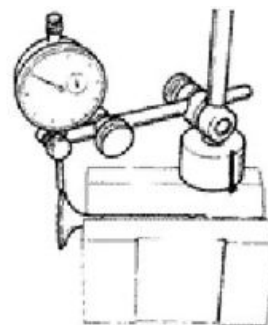

Inspecting the valve stem guide clearance

- After measuring the valve guide diameter and the valve stem diameter, check the clearance between guide and stem.

INLET

Specification	Desc./Quantity
Standard clearance:	0.013 ÷ 0.04 mm
Limit allowed:	0.08 mm

OUTLET

Specification	Desc./Quantity
Standard clearance:	0.025 ÷ 0.052 mm
Limit allowed:	0.09 mm



VALVE STANDARD LENGTH

Specification	Desc./Quantity
Inlet:	95.0 ± 0.3 mm
Outlet:	94.2 ± 0.3 mm

- Check that there are no signs of wear on the faying surface with the set screw articulated terminal.

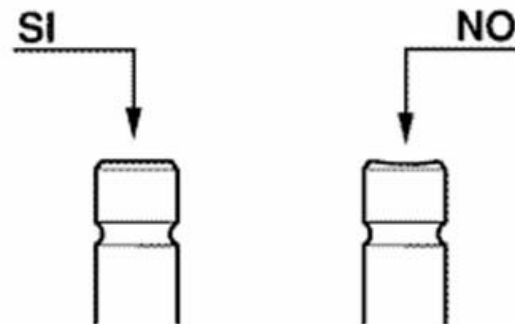

- If no anomalies are found during the above checks, the same valves can be reused. For better sealing results, it is advisable to grind the valve seats. Grind the valves gently with fine-grained lapping compound. Upon grinding, keep the cylinder head in horizontal position. This will prevent the lapping compound residues from penetrating between the valve stem and the guide (see figure).



CAUTION
TO AVOID SCORING THE FAYING SURFACE, DO NOT ROTATE THE VALVE WHEN NO LAPPING COMPOUND IS LEFT. CAREFULLY WASH THE CYLINDER HEAD AND THE VALVES WITH A SUITABLE PRODUCT FOR THE TYPE OF LAPPING COMPOUND BEING USED.

CAUTION
DO NOT CHANGE THE VALVE FITTING POSITION (RH - LH).

Inspecting the springs and half-cones

- Check that the upper and lower supporting spring plates, the cotters and the oil seal show no sign of abnormal wear. Otherwise, replace the component.



- Measure the unloaded spring length.

Characteristic

Standard length:

44.4 mm

Limit allowed after use:

42.4 mm



Refitting the valves

- Place the valve spring supporting plates on the head.
- Fit the 4 oil seals alternately with the specific tool.
- Lubricate the oil seals and the valve guides.

Specific tooling

020306Y Punch for fitting valve sealing rings



- Fit the valves, the springs and the plates. Using the specified tool with the appropriate adaptor, compress the springs and insert the cotters in their seats.

Specific tooling

020382Y Tool for removing valve cotters fitted with part 012

020382Y012 bushing (valve removing tool)



NOTE

DO NOT CHANGE THE VALVE FITTING POSITION. FIT THE VALVE SPRINGS WITH THE REFERENCE COLOUR ON THE COTTERS SIDE (TURNS WITH GREATER PITCH).

- Place the valve spring supporting plates on the head.
- Fit the 4 oil seals alternately with the specific tool.
- Lubricate the oil seals and the valve guides.



Specific tooling

020306Y Punch for fitting valve sealing rings

- Fit the valves, the springs and the plates. Using the specified tool with the appropriate adaptor, compress the springs and insert the cotters in their seats.



Specific tooling

020382Y Tool for removing valve cotters fitted with part 012

020382Y012 bushing (valve removing tool)

NOTE

DO NOT CHANGE THE VALVE FITTING POSITION. FIT THE VALVE SPRINGS WITH THE REFERENCE COLOUR ON THE COTTERS SIDE (TURNS WITH GREATER PITCH).

Inspecting the cam shaft

- Check the camshaft bearings for signs of abnormal wear or scores.
- Using a micrometer, measure the camshaft bearings.

STANDARD DIAMETER

Specification	Desc./Quantity
Bearing A Ø:	42- 0.060 -0.085 mm
Bearing B Ø:	20- 0.020 -0.041 mm

MINIMUM DIAMETER ALLOWED

Specification	Desc./Quantity
Bearing A Ø:	41.910 mm
Bearing B Ø:	19.940 mm

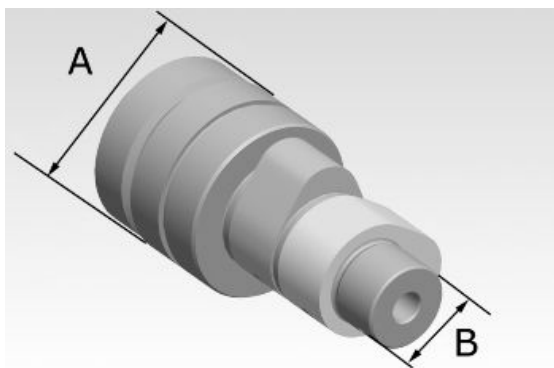

- Using a gauge, measure the height of the cams.

STANDARD HEIGHT

Specification	Desc./Quantity
inlet	33.774 mm
outlet	33.273

LIMITS ALLOWED

Specification	Desc./Quantity
inlet	33.526 mm
outlet	33.026 mm
Standard axial clearance:	0 ÷ 0.22 mm
Maximum axial clearance allowed:	0.3 mm

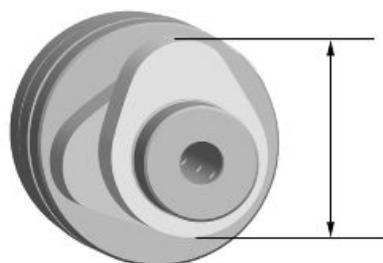

- If values measured are not within the specified limits or there are signs of excessive wear, replace the defective components with new ones.
- Check that the groove, shown in the figure, that is the retention plate seat, exhibits no wear.

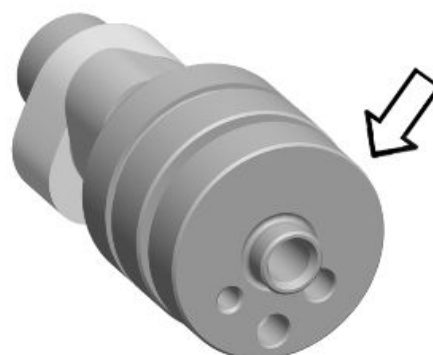

- Check there are no signs of wear on the automatic valve-lifter cam, the end-of-stroke roller and the rubber buffer on the automatic valve lifter retaining cover.
- Check that the automatic valve-lifter return spring is not deformed by over-stretching.
- Replace any defective or worn component.



- Check there are no signs of wear or scoring on the rocking lever pins.

Characteristic

Standard diameter:

Ø 13 - 0.010 -0.018 mm

- Check the inside diameter of each rocking lever.

Characteristic

Standard diameter:

Ø 13 + 0.026 +0.015 mm



- Check there are no signs of wear on the contact pads with the cam and on the articulated plate of the set screws.
- In case of wear, replace the component.

Refitting the head and timing system components

- Fit the chain guide slider.
- Fit the two centring dowels between head and cylinder.
- Fit the head gasket.



NOTE

THE FIGURE SHOWS THE FITTING POSITION OF THE TWO CENTRING DOWELS BETWEEN HEAD AND CYLINDER. THE DIRECTION OF FITTING FOR THE GASKET IS FORCED BY THESE DOWELS.

- The head gasket is made of steel and has a standard thickness.



- Check that the head lubrication channel is perfectly clean. Clean with short blasts of compressed air, if required.
- Fit the head.
- Lubricate the screw studs and the 4 fixing stud bolts.

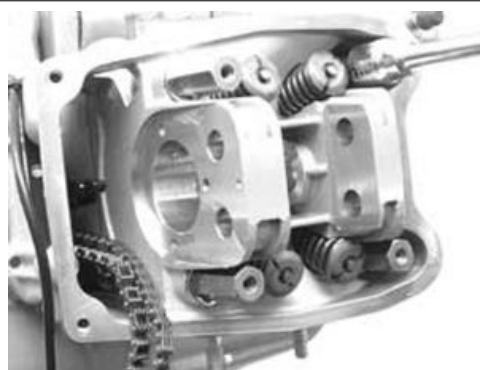

- Tighten the 4 fixing stud bolts in a criss-crossed sequence to the prescribed torque as shown in the figure.

Locking torques (N*m)

Head fixing stud bolts ***

- *** First, apply a preliminary torque of 7 Nm in a criss-crossed sequence.
- tighten by 90° in a criss-crossed sequence.
- tighten again by 90° in a criss-crossed sequence.

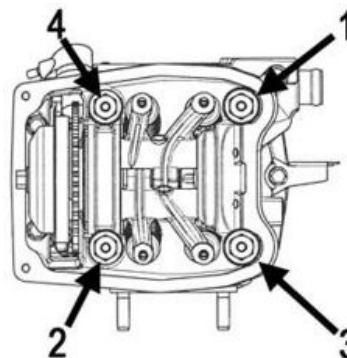

- Tighten the fixing nuts on the outlet side and the intake side to the prescribed torque.

Locking torques (N*m)

Exhaust/ intake head fixing nuts 10 - 12

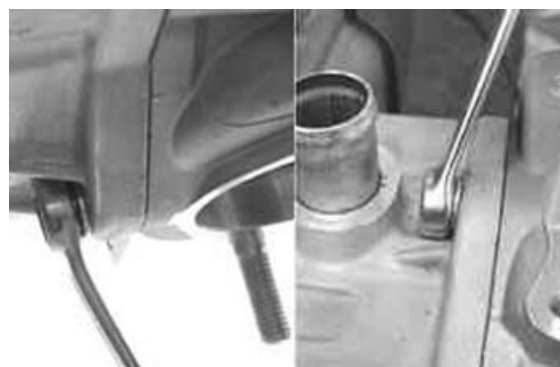

- Tighten the 3 side screws to the prescribed torque.

Locking torques (N*m)

Head fixing screws 10 - 12

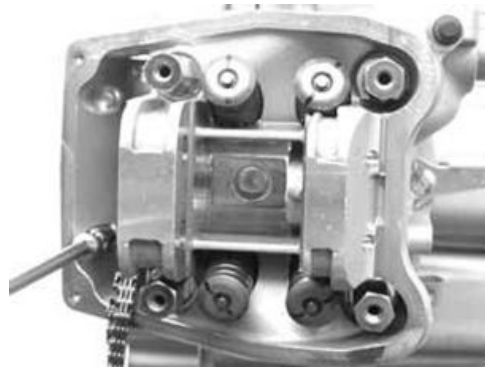

- Fit the coolant temperature sensor with the washer and tighten it to the prescribed torque.

CAUTION

FAILURE TO OBSERVE THE LOCKING TORQUE CAN DAMAGE THE SENSOR.

Locking torques (N*m)

Coolant temperature sensor 10 - 12



- Fit the spark plugs and tighten them to the prescribed torque.

Locking torques (N*m)

Spark plug 12 ÷ 14 Nm

- Fit the timing control chain on the crankshaft observing the initial direction of rotation.
- Fit the tensioner pad with the relevant spacer, tightening the fixing screw to the prescribed torque, using the recommended product.

Recommended products

Loctite 243 Medium strength threadlock

-



Locking torques (N*m)

Tensioner pad fixing screw 10 - 14

- Fit the pins and the rocking levers operating on the flywheel side.
- Lubricate the 2 rocking levers through the holes at the top.



- Clean the camshaft by blowing short blasts of compressed air, especially the groove that holds the retaining plate.
- Lubricate the 2 bearings.
- Fit the camshaft in the cylinder head with the cams opposing the rocking levers.



- Remove any LOCTITE left on the screws fixing the camshaft retaining bracket using a brush.
- Apply the recommended product to the fixing screws and tighten them to the prescribed torque.

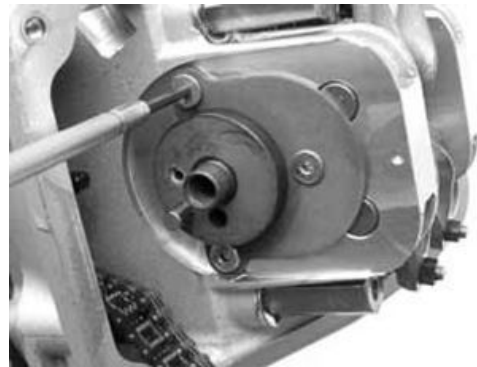

Recommended products

Loctite 243 Medium strength threadlock

-

- Insert the camshaft retaining bracket so that the countersinks are visible and tighten the 3 fixing screws to the prescribed torque, being careful not to damage the internal hexagon.

Locking torques (N*m)

Camshaft retaining bracket screws 4 ÷ 6

- Fit the intermediate gear with torque limiter and the flywheel and its cover as described in the «Flywheel and Start-up system» and «Flywheel cover» Chapters.

NOTE

FOR FACILITATE THE OPERATION, FIT THE FLYWHEEL COVER WITHOUT THE COOLING SYSTEM SLEEVES.

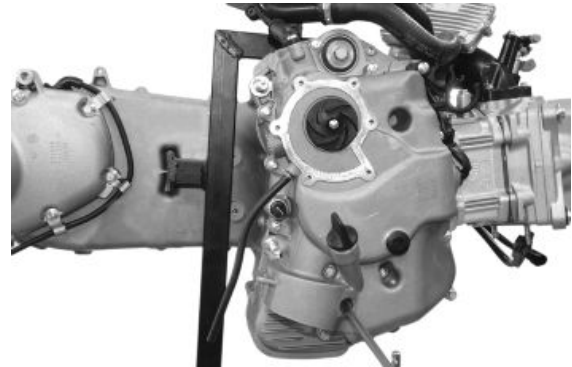

- With the TORX wrench, remove the timing check cap.



- Fit the chain on the camshaft control timing system gear.
- Fit the timing system gear on the camshaft making sure that references are aligned.

NOTE

UPON CHECKING TIMING, KEEP THE CHAIN TAUTENED BY EXERTING PRESSURE FROM THE TIGHTENER COMPARTMENT.



- Keeping the chain slightly pulled, turn the crankshaft using the driving pulley until the reference on the magnet support is aligned with that on the flywheel cover.



- Install the counterweight mass.
- Centre using the cover fixing screw.
- Lock the mass fixing screws to the prescribed torque, using the recommended product.

Recommended products

Loctite 243 Medium strength threadlock

-

Locking torques (N*m)

Counterweight screw 7 ÷ 8.5 Nm

- Remove the central screw.
- Fit the valve-lifter mass being careful to position the end of stroke ring adequately.
- Lubricate the mass and pressure reducer control pin.

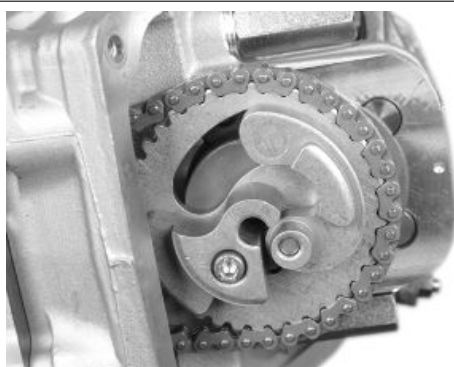
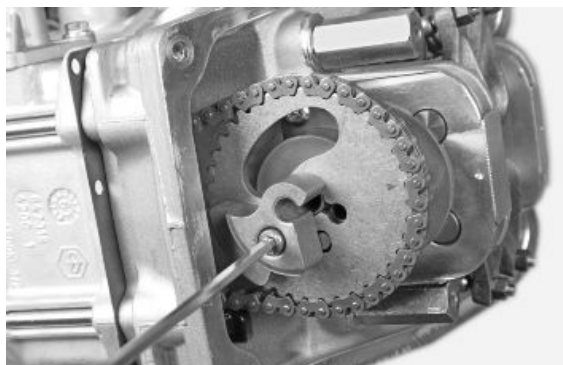

- Fit the return spring and load it by about 3/4 of a turn.



- Turn the engine to move the references to the top as shown in the figure (intake end).

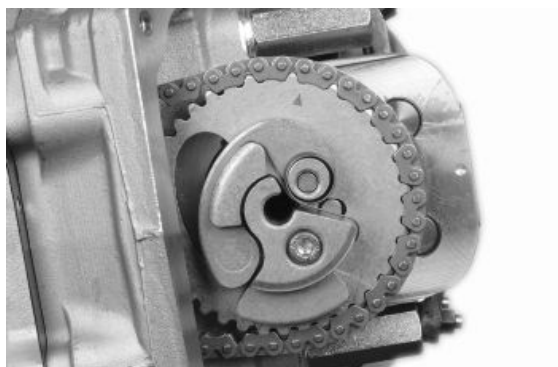

- Fit the valve-lifter mass retainer cover.
- Tighten the fixing screw to the prescribed torque, using the recommended product.

NOTE

BELL TIMING IS ENSURED BY THE BALANCE WEIGHT MASS FIXING SCREW HEAD.

Recommended products

Loctite 243 Medium strength threadlock

-

- Check that the decompression mass is free and that it is pulled by the spring.

Locking torques (N*m)

Screw fixing the valve-lifter retaining cover 30 - 35

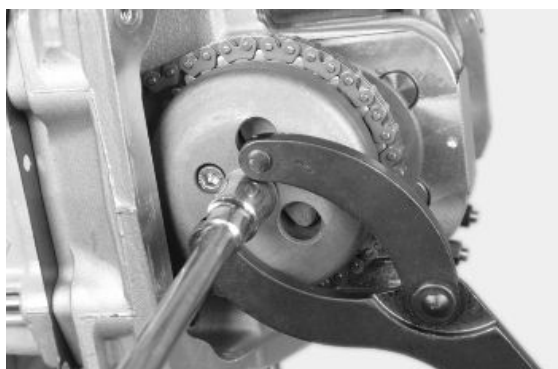

- Place the tensioner slider at the rest position, keeping the retaining tab pressed.



- Fit the chain tensioner on the cylinder, using a new gasket.
- Tighten the two fixing screws to the prescribed torque.



Locking torques (N*m)

Tensioner fixing screws 11 ÷ 13

- Fit the spring with the central screw and the washer.
- Tighten the central screw to the prescribed torque.



Locking torques (N*m)

Tensioner screw 5 ÷ 6

- Place the engine with the valve clearance adjustment timing references aligned with the head.
- Check the clearance between valve and rocking lever using a thickness gauge.

PRESCRIBED CLEARANCE

Specification	Desc./Quantity
Inlet	0.15 mm (with cold engine)
Outlet	0.15 mm (with cold engine)

- If different values are detected, adjust by loosening the lock nut and operating on the set screw with a screwdriver, as shown in the figure.



Refitting the timing chain

The ignition advance is determined electronically on the basis of parameters known by the control unit. For this reason it is not possible to state the reference values based on the engine revs.

The ignition advance value can be measured at any time with the diagnostic tester.

It is possible to check whether the ignition advance determined by the injection system does in fact correspond with the value actually activated on the engine, by means of the stroboscopic light.

Specific tooling

AP8140595 Axone + battery charger (230V 50Hz)

AP8202311 Axone + battery charger (110V 60Hz)

020330Y Stroboscopic light for timing checking

Proceed as follows:

- Remove the external transmission cover as described in the «Automatic transmission» chapter.



- Remove the cap to inspect the TDC reference found between the flywheel and cover housing. Refer to the «Flywheel cover» chapter.



-
- Acting on the driving pulley nut, turn the engine until the references to determine the TDC are found.



-
- Repeat for the reference between the driving pulley and the transmission cover



-
- Connect the diagnostic tester.
 - Start the engine.
 - Select the «parameter» function from the menu.
 - Select the stroboscopic light control in the traditional four-stroke engine position (1 spark, 2 revs).
 - Check that the real values of revs and ignition advance match those measured using the diagnostic tester.
 - Refit the inspection cap on the flywheel side.



Specific tooling

AP8140595 Axone + battery charger (230V 50Hz)

AP8202311 Axone + battery charger (110V 60Hz)

If the values do not correspond, check:

- distribution timing
 - rpm timing sensor
 - injection control unit
-

Refitting the rocker-arms cover

- Check that the gasket is in good condition.

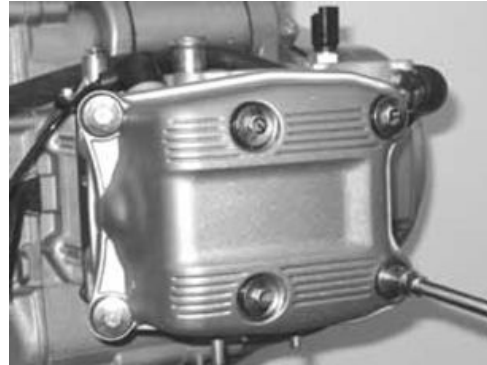

- Tighten the two screws indicated in the figure with «1» and «2» to limit the reciprocal sliding of the cover surface with the head surface.
- Tighten the remaining 4 screws in a criss-crossed sequence (3,4,5,6).

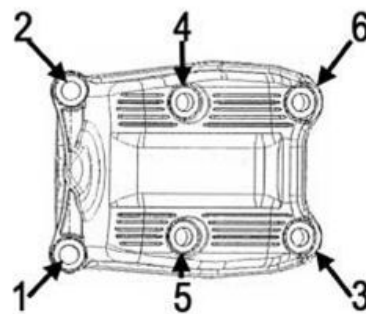

NOTE

PAY ATTENTION TO THE CORRECT POSITION OF THE GASKET.

Locking torques (N*m)

Tappet cover fixing screws 7 - 9

- Fit the driving pulley with the mesh filter and the external transmission cover as described in the «Automatic transmission» chapter.



- Fit the cooling system sleeves using new clamps as described in the «Flywheel cover» Chapter.

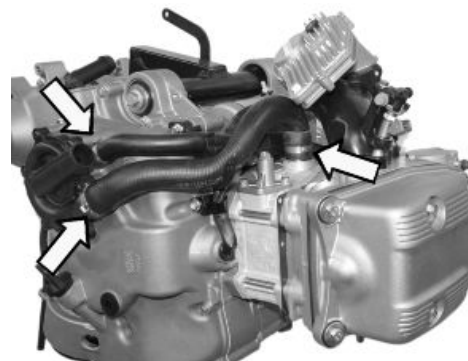

Refitting the intake manifold

- Fit the inlet manifold to the engine.
- Insert the 3 fixing screws, one of which with a supporting clamp for the cooling system sleeve, and tighten them to the prescribed torque.

Locking torques (N*m)

Inlet manifold screws 11 ÷ 13



Crankcase - crankshaft

- Remove the external and internal transmission covers and the driving and driven pulleys as described in the «Automatic transmission» chapter.
- Remove the flywheel cover with the cooling system sleeves as described in the «Flywheel cover» chapter.
- Remove the magneto flywheel with the start-up control as described in the «Magneto flywheel removal» chapter.
- Remove the thermal group (cylinder, head, piston) as described in the «Thermal group and Timing system» chapter.
- Before opening the engine crankcase, it is advisable to check the axial clearance of the crankshaft. For this purpose, use a plate (e.g. the specific tool) and a support with specific tool dial gauge.

Specific tooling

020262Y Crankcase splitting strip

020335Y Dial gauge magnetic support

Characteristic

Standard clearance:

0.10 ÷ 0.50 mm

Increased limit after use:

0.60 mm

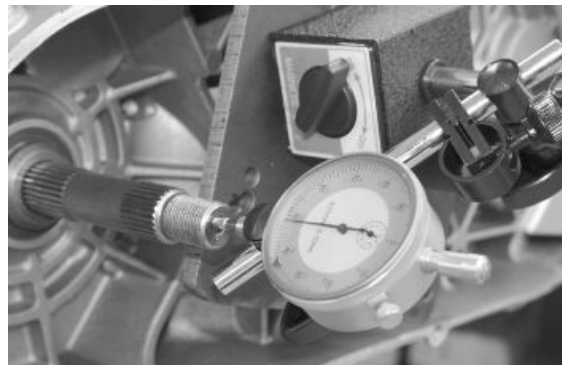

- Higher clearances are signs of wear on the supporting surfaces of the crankshaft on the crankcase.
- To carry out an accurate measurement, measure the clearance in both directions between crankcase and crankshaft.

- Remove the external and internal transmission covers and the driving and driven pulleys as described in the «Automatic transmission» chapter.

- Remove the flywheel cover with the cooling system sleeves as described in the «Flywheel cover» chapter.
- Remove the magneto flywheel with the start-up control as described in the «Magneto flywheel removal» chapter.
- Remove the thermal group (cylinder, head, piston) as described in the «Thermal group and Timing system» chapter.
- Before opening the engine crankcase, it is advisable to check the axial clearance of the crankshaft. For this purpose, use a plate (e.g. the specific tool) and a support with specific tool dial gauge.

Specific tooling**020262Y Crankcase splitting strip****020335Y Dial gauge magnetic support****Characteristic****Standard clearance:**

0.10 ÷ 0.50 mm

Increased limit after use:

0.60 mm

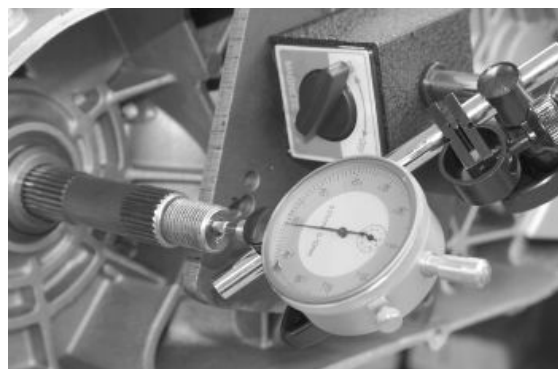

- Higher clearances are signs of wear on the supporting surfaces of the crankshaft on the crankcase.
- To carry out an accurate measurement, measure the clearance in both directions between crankcase and crankshaft.

Splitting the crankcase halves

- Remove the engine support retaining screw on the flywheel-side crankcase half.



- Remove the 14 crankshaft coupling screws.

NOTE

THE FIXING SCREWS COME IN 3 DIFFERENT LENGTHS. NOTE THEIR CORRECT POSITION.

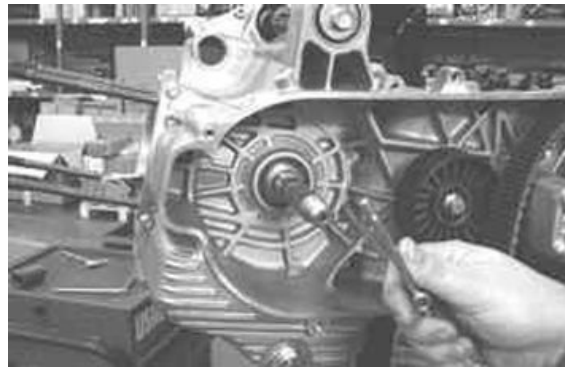

- Detach the crankcase halves keeping the crankshaft connected to the flywheel-side crankcase half.

- Remove the coupling gasket.

NOTE

THE BUSHING WHICH IS PART OF THE SUPPORT CAN BE LEFT IN THE FLYWHEEL-SIDE CRANKCASE HALF.



Removing the crankshaft

- Before removing the crankshaft, check the timing with the countershaft. To carry out this check, turn the crankshaft until the two holes on the crankshaft and the hole on the countershaft control gear are aligned.

This is another optimal position to remove the crankshaft.



- Remove the crankshaft with the shim washer on the flywheel side.

CAUTION

UPON OPENING THE CRANKCASE AND REMOVING THE CRANKSHAFT, CHECK THAT THE THREADED SHAFT ENDS DO NOT INTERFERE WITH THE MAIN BUSHINGS. FAILURE TO OBSERVE THIS WARNING CAN DAMAGE THE MAIN BUSHING.



Countershaft control gear and oil pump removal.

- To remove the control gear, undo the 4 fixing screws.

Remove the gear only if actually required.

CAUTION

THESE ARE COUNTERSUNK SCREWS AND THEIR THREADING IS LOCKED WITH LOC-TITE. BE CAREFUL NOT TO DAMAGE THE CONTROL HEXAGON. FOR BETTER RESULTS IT IS PREFERABLE TO USE AN INSIDE HEXAGON BOX-SPANNER.



Removing the countershaft

- Place the specific tool as shown in the figure.

Specific tooling

020479Y Countershaft lock wrench



- Remove the fixing nut with the relevant washer.



- Remove the specific tool and slide off the countershaft together with the control gear.



Replacing the countershaft bearings

- Check that the bearings are free from irregular noise or clearance. Otherwise, replace them.

Flywheel-side crankcase half

- Remove the internal Seeger ring.



- Turn the crankcase half over.
- Remove the bearing from the flywheel-side crankcase half using the specific tool and a mallet.

Specific tooling

020376Y Adaptor handle

020358Y 37 x 40 mm adaptor

020439Y 17-mm guide



- Remove the bearing from the transmission-side crankcase half using the specific tool.

Specific tooling

001467Y008 Pliers to extract Ø 17-mm bearings

001467Y007 Driver for bearings with OD 54 mm



- Before fitting a new bearing, heat the flywheel-side crankcase half using the specific tool.
- Place the crankcase half on a wooden base.

Specific tooling

020151Y Air heater

020150Y Air heater support



- First grease the guide seat and then fit a new bearing on the specific tool.
- Fit a new bearing on the crankcase half using the specific tool.

NOTE

IF A BEARING WITH PLASTIC CAGE IS USED, KEEP THE BALLS VISIBLE FROM THE CRANKCASE INTERNAL SIDE.

Specific tooling

020376Y Adaptor handle

020359Y 42 x 47 mm adaptor

020439Y 17-mm guide



- Fit the Seeger ring.



- Before fitting the new bearing on the transmission-side crankcase, heat the seat using the specific tool.

Specific tooling

020151Y Air heater

020150Y Air heater support



- First grease the guide seat and then fit a new bearing on the specific tool.
- Fit a new bearing on the engine crankcase with the specific tool.

NOTE

IF A BEARING WITH PLASTIC CAGE IS USED, KEEP THE BALLS VISIBLE FROM THE CRANKCASE INTERNAL SIDE.

Specific tooling

020376Y Adaptor handle



020359Y 42 x 47 mm adaptor

020439Y 17-mm guide

Inspecting the crankshaft components

- Check the connecting rod axial clearance.

Characteristic

Standard clearance:

0.20 ÷ 0.40 mm



- Check the connecting rod diametral clearance.

Characteristic

Standard clearance:

0.046 ÷ 0.076 mm

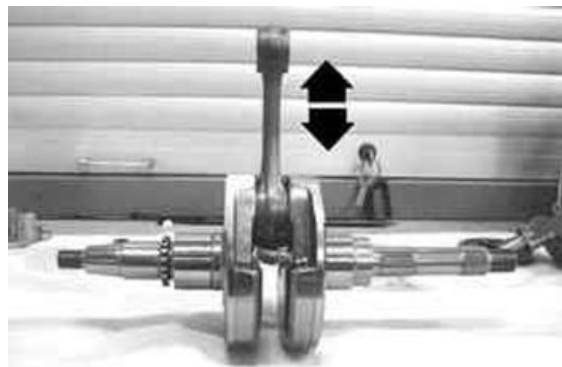

- Check that the surfaces that limit the axial clearance are not scored and with the aid of a gauge measure the crankshaft width as shown in the figure.

NOTE

BE CAREFUL NOT TO LET THE MEASUREMENT BE AFFECTED BY THE UNIONS WITH THE CRANKSHAFT BEARINGS.

Characteristic

Standard sizes:

63.6 ÷ 63.45 mm

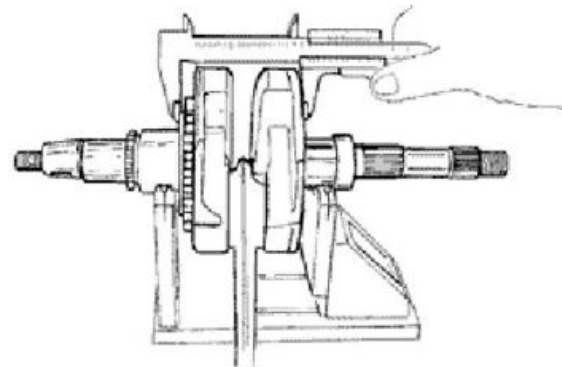

CAUTION

THE CRANKSHAFT CAN BE REUSED WHEN ITS WIDTH IS WITHIN THE STANDARD VALUES AND THE SURFACES SHOW NO SIGNS OF SCORING.

Shim washer

- Check the overall size of the crankshaft-shoulders-gear assembly.

Characteristic

Standard thickness:

71.804 ÷ 72.000 mm

- Check that the shim washer is not scored.

NOTE

IF IT IS REUSED, KEEP ITS ORIGINAL FITTING POSITION.

Specific tooling

020074Y Supporting base for checking crankshaft alignment

- If the crankshaft-crankcase axial clearance exceeds the standard and the crankshaft does not show any defect, the problem must be due to either excessive wear or wrong machining on the crankcase.

- Check the diameters of both crankshaft bearings according to the axes and surfaces shown in the figure. Half-shafts are classified in two categories, Cat 1 and Cat 2, as shown in the chart below.

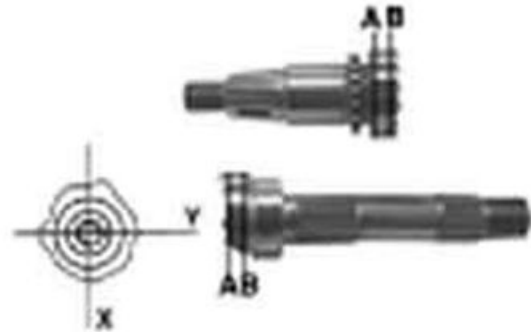

STANDARD DIAMETER

Specification	Desc./Quantity
Cat. 1	40.010 ÷ 40.016
Cat. 2	40.016 ÷ 40.022

Inspecting the crankshaft alignment

- Install the crankshaft on the support and measure the misalignment at the 4 points indicated in figure.

Specific tooling

020074Y Supporting base for checking crankshaft alignment

MAXIMUM OFF-LINE ALLOWED

Specification	Desc./Quantity
A	= 0.15 mm
B	= 0.01 mm
C	= 0.01 mm
D	= 0.10 mm

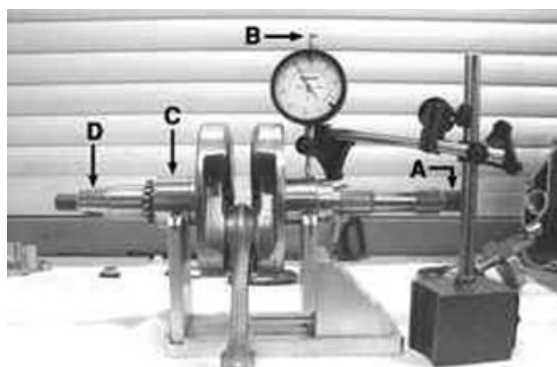

- Check that the crankshaft cone, the tab fitting, the oil seal flow, the knurling and the threaded tabs are in good working order.
- In case of failure, replace the crankshaft.

NOTE**CRANKCASE BEARINGS ARE NOT GRINDABLE.**

The connecting rod cannot be replaced. To check the connecting rod small end diameter, see the «Thermal group and Timing system» chapter.

- When cleaning the crankshaft, be very careful that no impurities get in through the shaft lubrication hole.

NOTE

SHOULD A CRANKSHAFT CONSISTING OF TWO HALF-SHAFTS OF DIFFERENT CATEGORIES NEED REPLACING, REPLACE BOTH CRANKCASE HALVES AS WELL, COUPLING THE TWO COMPONENTS (SHAFT AND CRANKCASE) WITH THE SAME CATEGORY.

- To check the gearing of the crankshaft, see the «Thermal group and Timing system» chapter.

**See also**

[Cylinder assy. and timing system](#)

Inspecting the crankcase halves

- Before checking the crankcase halves, thoroughly clean all the surfaces and oil pipes.
- For the transmission-side crankcase half, special attention should be given to the bushings, the cooling jet on the transmission side (see figure) and the lubrication duct.



NOTE

THE JET IS FED THROUGH THE MAIN BUSHINGS. PROPER OPERATION OF THIS COMPONENT IMPROVES PISTON CROWN COOLING. CLOGGING HAS EFFECTS THAT ARE DIFFICULT TO DETECT (PISTON TEMPERATURE INCREASE). FAILURE OR LEAKAGE CAN CONSIDERABLY CAUSE A DROP IN LUBRICATION PRESSURE FOR THE MAIN BUSHINGS AND CONNECTING ROD.

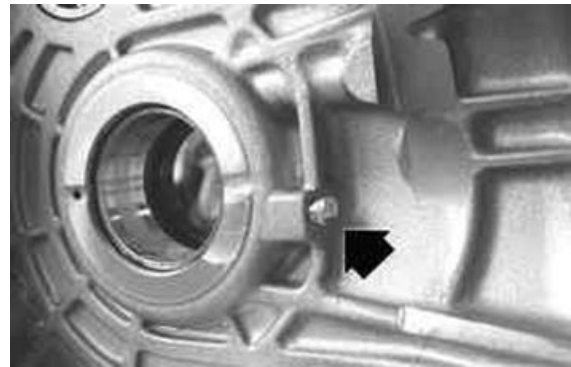

- For the flywheel-side crankcase half, special attention should be given to the lubrication channels for the main bushings and to the compartment and channels for the oil pump, as well as to the duct for the by-pass located on the flywheel cover.

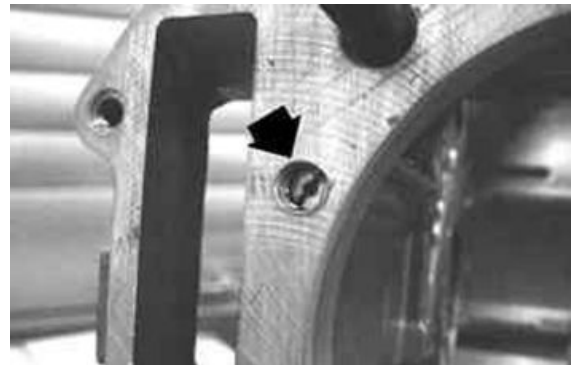
**NOTE**

AS ALREADY DESCRIBED IN THE LUBRICATION CHAPTER, IT IS ESPECIALLY IMPORTANT THAT THE BY-PASS VALVE HOUSING SHOWS NO WEAR THAT MAY IMPAIR THE PROPER SEALING OF THE LUBRICATION PRESSURE ADJUSTMENT PISTON. THE HEAD LUBRICATION CHANNEL IS FITTED WITH A SHUTTER JET; THIS GIVES A "LOW PRESSURE" HEAD LUBRICATION. THIS CHOICE HAS BEEN MADE TO REDUCE THE OIL TEMPERATURE IN THE SUMP.

Jet clogging impairs head lubrication and the timing mechanisms.

A jet failure causes a drop in lubrication pressure for the main bushings and connecting rod.

- Check the coupling surfaces for scratches or deformation, paying special attention to the cylinder - crankcase surfaces and the crankcase halves coupling surfaces.
- Defects in the crankcase coupling gasket or the surfaces can cause a drop in the oil pressure and affect the lubricating pressure.
- Check that the surfaces limiting the crankshaft axial clearance show no signs of wear. To measure and check sizes follow the procedure described previously for checking crankshaft axial clearance and dimensions

Inspecting the crankshaft plain bearings

- In order to obtain proper bushing lubrication, make sure there are both an outstanding lubrication pressure (4.5 bar) and a good oil flow rate. To that end, the bushings must be correctly positioned so as not to obstruct the oil supply channels.
- The main bushings are comprised of 2 half-bearings, one with holes and channels for lubrication while the other is solid.

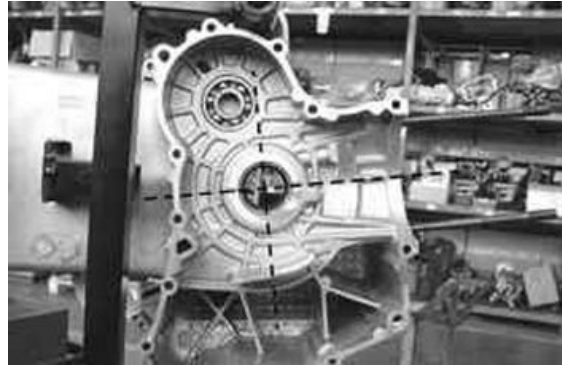

- The solid half-bearing is intended to stand the thrusts caused by combustion, and for this reason, it is arranged opposed to the cylinder.
- So as not to obstruct the oil supply channels, the coupling surface of the two half-bearings must be perpendicular to the cylinder axis as shown in the figure.
- The oil supplying channel section is also influenced by the depth to which the bushings are driven compared with the crankshaft axial clearance of the limiting surface.

NOTE

TO KEEP THIS POSITION OF THE BUSHINGS ON THE CRANKCASE, FITTING IS FORCED ON CAST IRON RINGS INSERTED IN THE CASTING OF CRANKCASE HALVES.

- Measure the bushings diameter at the 3 positions indicated in the figure.
- Repeat the measurements for the other half of the bushing. See figure.

NOTE

DO NOT TAKE THE MEASUREMENT ON BOTH HALF-SHELLS COUPLING SURFACE SINCE THE ENDS ARE RELIEVED TO ALLOW BENDING DURING THE DRIVING OPERATION.

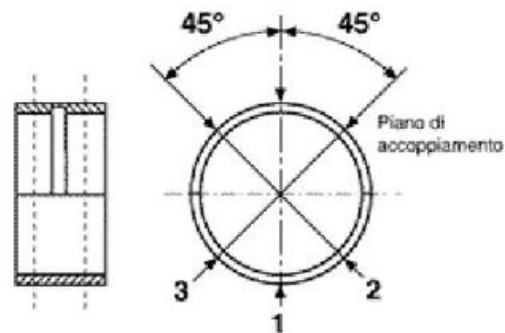

Before fitting, check that the clearance between the engine crankcase bushing and the crankshaft is within the predetermined limits.

Characteristic

Crankshaft-bushing maximum clearance allowed:

0.08 mm

- The standard bushing diameter after driving varies according to a coupling selection.
- The crankcase bushing seats are classified into 3 categories while the crankshaft ones, into 2 categories.
- The main bushings are subdivided into 4 categories according to thickness (see table).

MAIN BUSHING CHECK

Name	Description	Dimensions	Initials	Quantity
Type A - Red		1.971 ÷ 1.974		
Type B - Blue		1.974 ÷ 1.977		
Type C - Yellow		1.977 ÷ 1.980		
Type D - Green		1.980 ÷ 1.983		

Coupling chart

Depending on the type of crankshaft/crankcase coupling, the following types of bushings listed in the table should be used.

		X	
		1	2
Y	1	B	A
	2	C	B
	3	D	C

KEY

X = Crankshaft category

Y = Crankcase half-shells category

A = Red

B = Blue

C = Yellow

D = Green

In case of breakdown, crankcases come together with bushings and are classified according to the axial distance of the countershaft. Find below the possible couplings.

- Complete FC1 crankcase equipped with bushings to house a category 1 crankshaft and a countershaft with axial distance A.

- Complete FC2 crankcase equipped with bushings to house a category 2 crankshaft and a countershaft with axial distance A.

- Complete FC3 crankcase equipped with bushings to house a category 1 crankshaft and a countershaft with axial distance B.
- Complete FC4 crankcase equipped with bushings to house a category 2 crankshaft and a countershaft with axial distance B.

NOTE

THE CRANKSHAFT CATEGORY IS STAMPED ON THE COUNTERWEIGHT SHOULDER.

Furthermore a replacement crankcase cannot be matched with a crankshaft with mixed categories. The replacement crankshaft has half-shafts of the same category.

NOTE

TO REPLACE THE HALF-SHAFTS, REMOVE THE COUNTERSHAFT BEARINGS AS DESCRIBE ABOVE. REMOVE THE COMPLETE DRIVEN PULLEY AND THE ANTI-FLAPPING ROLLER FROM THE TRANSMISSION-SIDE CRANKCASE HALF, AS DESCRIBED IN THE «AUTOMATIC TRANSMISSION» CHAPTER, AND THE HUB COVER WITH THE RELEVANT GEARS AND BEARINGS AS DESCRIBED IN THE «FINAL REDUCTION» CHAPTER.

Countershaft

- Using a micrometer, measure the 2 countershaft bearings as shown in the figure.

Characteristic**Standard diameter:**

17 - 0.01 - 0.02 mm



- Check that the water pump drive is not worn.
-

Refitting the crankshaft

- Check that the oil pump and countershaft control gear are not dented or distorted. Otherwise, replace them.

NOTE

SHOULD THE OIL PUMP AND THE COUNTERSHAFT CONTROL GEAR NEED TO BE REPLACED, IT IS NECESSARY TO REPLACE THE COUNTERSHAFT GEAR AS WELL.

- Before installing the gear on the crankshaft, thoroughly clean both coupling surfaces and remove any residues of LOCTITE left in the holes using a brush.



Blow with compressed air and degrease the mounting holes on both surfaces to facilitate adherence of the new LOCTITE applied.

Apply the recommended product on the holes again.

Recommended products

Loctite 243 Medium strength threadlock

-

- Repeat the same procedure for the 4 fixing screws.
- Insert the control gear on the crankshaft with the bore countersink visible.
- Tighten the 4 fixing screws to the prescribed torque.

NOTE

TO AVOID DAMAGING THE SCREW CONTROL HEXAGON, IT IS PREFERABLE TO USE AN INSIDE HEXAGON BOX-SPANNER.

Locking torques (N*m)

Gear on crankshaft screws 10 -12

- Lubricate the main bearing on the flywheel-side crankcase half.
- Lubricate the shim washer.
- Insert the shim washer on the crankshaft in its original position.
- Insert the special timing tool in the hole on the countershaft.



Specific tooling

020471Y Pin for countershaft timing

- Insert the crankshaft on the pin and afterwards into the bushing with great care.
- Before inserting it thoroughly, align the oil pump gear with the control gear.
- Insert thoroughly and remove the specific tool.

**NOTE**

UPON INSERTING THE SHAFT ON THE CRANKCASE HALF, BE CAREFUL NOT TO DAMAGE THE MAIN BEARING WITH THE THREADED TANG OF THE CRANKSHAFT AND WITH THE TIMING CONTROL TOOTHED PINION.

- Install the oil pump housing cover.
- Tighten the 2 flanged fixing screws to the prescribed torque.

Locking torques (N*m)

Oil pump compartment cover bulkhead screws 8 - 10



Refitting the crankcase halves

- Remove the oil guard from the transmission-side crankcase half using a screwdriver.



- First lubricate a new oil guard and then fit it using the specific tool, place it 0.5 mm recessed from the crankcase plane.

CAUTION

A WRONGLY POSITIONED OIL GUARD ADVERSELY AFFECTS THE LUBRICATION OIL CIRCULATION.

Specific tooling

020360Y 52 x 55 mm adaptor



020376Y Adaptor handle

- Insert the gasket on the flywheel-side crankcase half.

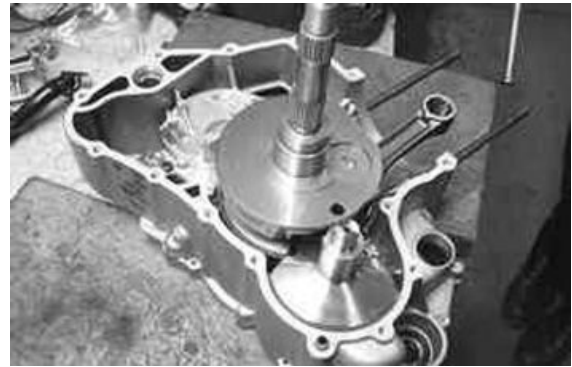

- Lubricate the main bearing on the transmission-side crankcase half.

- **Couple both crankcase halves being careful not to damage the bushing on the transmission-side crankcase half with the threaded tang of the crankshaft.**

- Insert but do not tighten the engine support retaining screw on the flywheel-side crankcase half.
- Insert the 14 fixing screws by arranging the single shorter screw «A» and the single longer screw «B» as shown in the figure.



- Screw in the screws as far as they will go and then tighten to the prescribed torque.
- Check the crankshaft rotation.

NOTE

REMOVE ANY RESIDUES FROM THE CRANKCASE COUPLING GASKET ON THE CYLINDER SURFACE TO ENSURE BETTER SEALING.

Locking torques (N*m)**Engine crankcase coupling screws 11 ÷ 13**

- Install the thermal group (cylinder, head, piston) as described in the «Thermal group and Timing system» chapter.
- Install the magneto flywheel with the start-up control as described in the «Flywheel and Start-up system» chapter.
- Install the flywheel cover with the cooling system sleeves as described in the «Flywheel cover» chapter.
- Install the complete driving pulley, the transmission cover and the relevant mesh filter and the external transmission cover as described in the «Automatic transmission» chapter.

See also

[Cylinder assy. and timing system](#)
[Flywheel cover](#)

Lubrication

TECHNICAL SPECIFICATIONS

SUMP CAPACITY

Specification	Desc./Quantity
Oil change and filter replacement	1.7 l

RECOMMENDED ENGINE OIL

Product	Description	Specifications
AGIP CITY HI TEC 4T	Engine oil	SAE 5W-40, API SL, ACEA A3, JASO MA Synthetic oil

OIL PUMP

Specification	Desc./Quantity
Type	Trochoidal
Rotor shim washers	pressure pump: 12 mm (0.47 in) scavenge pump: 22 mm (0.87 in)
Fitting clearances	Lobe ends: 0.04 - 0.1 mm (0.0016 - 0.0039 in)
External rotor radial clearance	0.05 - 0.12 mm (0.0020 - 0.0047 in)
Flatness	0.015 mm (0.00059 in)

BY-PASS

Specification	Desc./Quantity
Type	with piston
Piston diameter	13.984 - 13.957 mm (0.5505 - 0.5495 in)
Unloaded spring length	52 mm (2.05 in)
Calibration pressure	4.5 bar (450 kPa) (65 PSI)

PRE-FILTER

Specification	Desc./Quantity
Type	mesh, plastic

OIL FILTER

Specification	Desc./Quantity
Type	paper filter with pressure relief and anti-drain by-passes

OIL MINIMUM PRESSURE INDICATOR SWITCH

Specification	Desc./Quantity
Calibration	0.3 ÷ 0.6 bar

HEAD LUBRICATION CONTROL JET

Specification	Desc./Quantity
Diameter	Ø 1 ± 0.05 mm *

* Tightening torque 5+7 N·m

PISTON COOLING NOZZLE

Specification	Desc./Quantity
Diameter	Ø 0.95 - 1.05 mm (0.037 - 0.041 in)

CRANKCASE VENTILATION CHECK

Specification	Desc./Quantity
Device	metal reed valve and decantation chamber

Conceptual diagrams

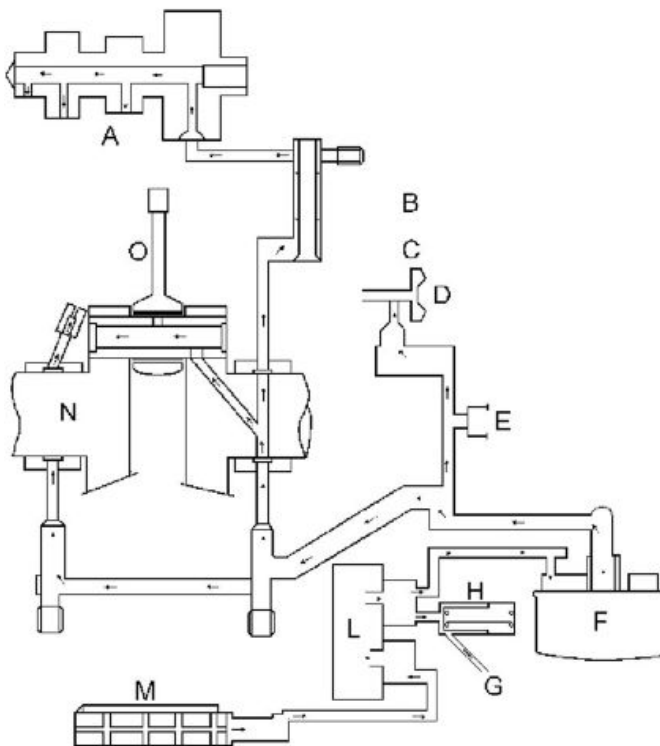

BASE DIAGRAM

Specification	Desc./Quantity
A	Camshaft
B	Cylinder-head plane
C	Cylinder-crankcase plane
D	Water pump rotor
E	Minimum oil pressure sensor
F	Oil filter cartridge
G	To the oil sump
H	By-pass valve
L	Oil pump
M	Oil mesh pre-filter
N	Crankshaft
O	Connecting rod

General characteristics

The lubrication system is divided into two sections:

- high pressure
- low pressure

The high pressure section includes all components located on the engine crankcase; while the low pressure section only refers to the thermal group.

The trochoidal pump is fitted to the sump and is controlled via a pair of gears.

To guarantee the integrity of the pump, a pre-filter is fitted.

This a screw-in type pre-filter and its plug serves also as the engine oil drainage plug.

Pump delivery is controlled by means of a piston by-pass calibrated to 4 bar. This is located upline of the cartridge filter and both are installed on the flywheel cover, so that the seal of the filter is subject to the system pressure.

The by-pass located upline the cartridge filter improves the operating conditions for the filter, particularly with cold oil.

The filter is equipped with an anti-drain valve and a pressure relief valve; the latter intervenes when the filtering element causes a pressure drop exceeding 1 ± 0.2 bar.

These conditions naturally occur only with cold oil and at high running engine or if the filter is dirty.

The filtered oil is used to lubricate the water pump shaft and once at the engine crankcase, to lubricate the main bearings, the connecting rod head and the piston cooling nozzle, located on the transmission-side bearing.

The main bearing on the transmission side is fitted with an oil seal and the respective drain line.

The supply line for the timing system comes from the flywheel-side bearing; the supply to the head is controlled by the specific spray jet in the engine crankcase.

The components of the timing system work with low-pressure oil.

The camshaft bearings are marked directly on the aluminium of the head; the camshaft axial clearance is partially compensated by the oil supplied to the smaller diameter bearing.

The camshaft supplies the lubricant to the rocking levers via the bores provided; these are installed in a position so as to ensure that the lubrication is maintained even after the vehicle has stopped. This is achieved when the camshaft reaches its most usual and likely position when the engine is switched off.

The oil used to lubricate the head returns to the sump via the chain casing channel and therefore it also provides lubrication for the chain.

In order to avoid that the gas collected from the crankcase carries oil, a one-way valve and a decantation chamber are used. The one-way valve is a metal reed valve; the decantation chamber has a drainage hole. A failure in these components implies oil getting into the line supplying air to the engine.

Excessive oil vapours may result in the clogging of ducts on the throttle body.

In order to signal low oil pressure in the system, a pressure switch is used, located immediately after the oil filter outlet.

The lubrication circuit does not include the countershaft; it is lubricated by the oil transported by the gearing or by the centrifugal effect of the crankshaft.

The same applies to the piston or the pin, but in this case the cooling nozzle is particularly important.

Diagnosis guide

1 - Minimum oil pressure warning light on with hot engine.

CONTINUE - go to point 2

2 - Remove the electric connector of the minimum pressure switch.

Check that the warning light turns off.

YES - go to point 3 NO go to point 11

3 - Check the actual oil pressure.

CONTINUE - go to point 4

4 - Remove the switch and fit the specific tool with the relevant gasket.

Specific tooling

AP8140181 Fuel pressure check tool

020434Y Fitting for oil pressure check

- Remove the dipstick with the oil filler plug and insert a plug with the temperature probe supplied with the specific tool. Insert the probe to feel contact with the crankcase bottom and pull back a few millimetres.

Specific tooling

020331Y Digital multimeter

CONTINUE - go to point 5



5 - Measure pressure with cold and idling engine.

STANDARD VALUES

Specification	Desc./Quantity
20°C Temperature	
1400 rpm	

~ 4.5 bar

Specific tooling

AP8140595 Axone + battery charger (230V 50Hz)

AP8202311 Axone + battery charger (110V 60Hz)

YES - go to point 6 NO go to point 12

6 - Let the engine warm up and repeat the check with hot oil.

STANDARD VALUES

Specification	Desc./Quantity
80°C Temperature	
1400 rpm	

~ 1.5 bar

YES - go to point 7 NO go to point 8

7 - Replace the minimum oil pressure.

8 - If pressure lower than $1.3 \div 1.5$ bar is measured.

CONTINUE - go to point 9

9 - Replace the oil filter and repeat the pressure check with oil at 80°C.

YES - go to point 10 NO go to point 13

10 - The failure is fixed.

It is recommended to observe the suggested number of kilometres covered.

11 - Check and restore the electrical system.

12 - If pressure lower than 4 bar is measured.

CONTINUE - go to point 9

13 - Remove the flywheel cover and check the efficiency of the by-pass valve and the cover sealing gasket towards the crankcase internal side as described in the "Flywheel cover" chapter.

YES - go to point 14 NO go to 15

14 - Check whether there is an irregular clearance on the crankshaft:

- axial clearance (see the "Crankcase and Crankshaft" chapter)
- radial clearance, especially in the direction of the cylinder axis
- clearance according to the direction of rotation with the connecting rod in quadrature

YES - go to point 16 NO go to point 17

15 - Replace the faulty components (flywheel cover chapter).

16 - Overhaul the engine (crankcase and crankshaft chapter).

17 - Open the engine crankcase and remove the oil pump, as described in the "Crankcase and Crankshaft" chapter.

- Check the oil pump as described in the following pages.

- Check that the cooling nozzle and the timing system supply jet are properly fitted.

- Visually inspect the crankshaft couplings and their size (crankcase and crankshaft chapter).

NOTE

ANY FAILURES IN THE COUPLINGS AND IN THE TIMING COMPONENTS CANNOT BE DETECTED BY THE LUBRICATION PRESSURE CHECK. THE FAILURES MAY BECOME EVIDENT BY AN INCREASE OF NOISE.

NOTE

IN CASE OF IRREGULAR PRESSURE ON THE BASE, CARRY OUT A VISUAL AND DIMENSIONAL INSPECTION OF THE TIMING COMPONENTS (SEE THERMAL GROUP AND TIMING SYSTEM CHAPTER).

Oil pressure check

1 - In case of oil or oil filter leaks, check the lubrication pressure.

CONTINUE go to point 2

2 - Fit the specific tool.

Specific tooling

AP8140181 Fuel pressure check tool

020434Y Fitting for oil pressure check

CONTINUE - go to point 3

3 - Check the system pressure with cold engine and medium - high speed.

Standard pressure < 6 bar

YES go to point 4 NO go to point 5

4 - Replace the damaged components.

5 - Check the adjustment by-pass efficiency and restore the proper sliding.

NOTE

STANDARD PRESSURES ARE OBTAINED USING OIL WITH THE PRESCRIBED VISCOSITY. A HIGHER VISCOSITY CAUSES AN INCREASE OF THE SYSTEM PRESSURE.

1 - If oil consumption is higher than 250 gr/1000 km on run-in engine, proceed as follows.

CONTINUE go to point 2

2 - Check the presence of oil at the recovery duct on the filter housing.

YES - go to point 3 NO go to point 4

3 - Check the efficiency of the one-way reed valve and the decantation chamber drainage hole.

YES - go to point 5 NO go to point 4

4 - Check the thermal group seals (piston rings, valve guides and oil seals), see the "Thermal group and Timing system" chapter.

5 - Restore the valve or the drainage hole efficiency.

Oil pump

Removal

- Remove the oil pump compartment cover by undoing the 2 fixing screws with their washers.



- Remove the oil pump together with the gearing by undoing the 2 fixing screws through the eyes machined in the gearing.



- Remove the gasket.



- Remove the two screws and the oil pump cover.



- Remove the internal rotor retaining circlip by turning it until the port matches the shaft face.



- Remove and wash the rotors thoroughly with petrol and compressed air.
- Extract the shaft with its gear and check that it is in good working order and without signs of wear.



- Reassemble the rotors in the pump body, keeping the 2 reference marks visible.
- Slide in the shaft with the gear and install the lock ring; afterwards turn it with the opening opposed to the shaft face.
- Check any irregular clearance between shaft and pump body.



- Measure distance between rotors with a thickness gauge at the position shown in the picture.

Characteristic

limit clearance allowed:

0.012 mm



- Measure the distance between the outer rotor and the pump body (see figure).

Characteristic

limit clearance allowed:

0.25 mm



- Check the rotor axial clearance using a trued bar as reference plane, as shown in the figure.

Characteristic

Limit value allowed:

0.1 mm



Refitting

- Make sure the gasket is in the correct position.

NOTE

THE TOOTH OF THE GASKET MUST BE IN ITS SEAT.



- Lubricate the internal rotors.
- Check there are no signs of wear or scoring on the oil pump cover.
- If you detect non-conforming values or scoring, replace the faulty parts.
- Fit the pump cover so positioned that the holes for the crankcase fixing screws are aligned.
- Tighten the two fixing screws to the prescribed torque.



Locking torques (N*m)

Oil pump cover screws 0.7 ÷ 0.9

- Fit the oil pump with its gear.
- Insert the 2 fixing screws through the slots on the gear and tighten them to the prescribed torque.

NOTE

THE ASSEMBLY POSITION OF THE PUMP IS CONSTRAINED BY THE INSTALLATION OF THE SCREWS.

Failure to observe the tightening torque may alter the coupling clearance between the rotors and the pump body.

Locking torques (N*m)

Screws fixing oil pump to crankcase 5 ÷ 6



- Fit the countershaft with the gearing to the fly-wheel-side crankcase half.

- Install the specific tool at the position shown in the figure

Specific tooling

020479Y Countershaft lock wrench



- Keep the countershaft in position and insert the washer with the nut.

- Tighten the nut to the prescribed torque using the recommended product.

- Remove the specific tool.

Recommended products

Loctite 243 Medium strength threadlock

-



Locking torques (N*m)

Countershaft fixing nut 25 ÷ 29

Pompa acqua

smontaggio

Specific tooling

020661Y Water pump overall sealing replacement kit

- Remove the six screws and the pump cover.



- With an 8-mm wrench, unscrew the water pump rotor.



- Use two flat blade screwdrivers, and place them as shown in the figure so as to lever on the marked crankcase edge and disassemble the overall sealing, pressure-fitted on the rotor shaft.

CAUTION

**USE TEFLON AS SHOWN IN THE FIGURE SO AS NOT TO DAMAGE THE WATER PUMP COVER SEALING SURFACE.
SMALL SCRATCHES ON THE SEATING EDGE DO NOT PRESENT ANY FUNCTIONAL PROBLEM.**



- Change the position of the screwdrivers if necessary.
- Upon disassembling the seal, the ceramic may split.



- Clean thoroughly all the parts before removing them.



- Place the extractor complete with pin on the static part of the ceramic seal.
- Without modifying the extractor position, make three holes on the static part of the seal using the pin supplied and a hammer.

NOTE

MAKE THE HOLES WITH A STRONG HIT. MULTIPLE BLOWS COULD DEFORM THE PART WITHOUT PASSING THROUGH.



- Fasten the extractor to the static part of the seal- ing, using the screws supplied with the tool.

CAUTION

FASTEN IT CORRECTLY WITHOUT "TEAR- ING" THE PLATE



- Complete the tool by fitting the bracket, screw and the nut.



- Hold the screw in one position and operate the nut until the static part of the sealing is completely removed.
- Remove the extractor with the static part of the overall sealing.



montaggio

OVERALL SEALING FITTING

CAUTION

CLEAN ALL THE COMPONENTS CAREFULLY.

CAUTION

LUBRICATE THE ROTOR SHAFT WITH OIL.



- Fit the tie rod screwing it in the rotor shaft.

CAUTION

FINGER TIGHTEN THOROUGHLY.

- Place the overall sealing on the shaft.



- Place the calibrated punch (with preloading values).
- Apply the nut to the tie rod.
- Keep the tie rod firm and screw the nut up to the end of stroke.
- The tool drives the fixed seat on the crankcase and the movable seat on the shaft, producing the correct ceramic seal preloading.



- Screw the rotor.

Locking torques (N*m)

Water pump rotor 4 ÷ 5



- Fit the pump cover with a new gasket, previously lubricated with petroleum jelly grease.
- Screw the six cover screws and tighten to the prescribed torque.

NOTE

DO NOT LUBRICATE THE O-RING WITH PETROLEUM GREASE TO AVOID DEFORMATION.

Locking torques (N*m)

Water pump cover screws 3 ÷ 4

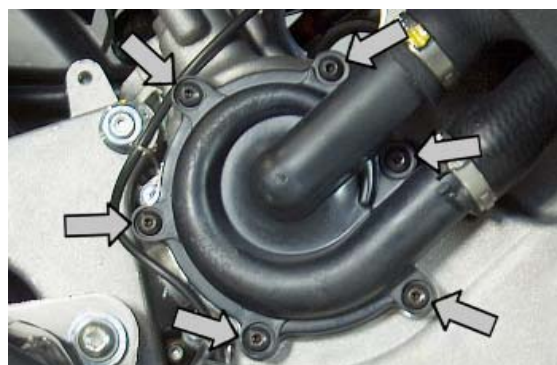

INDEX OF TOPICS

INJECTION

INJEC

**KEY:**

1. Instrument panel
2. Battery
3. Coolant temperature sensor
4. Fuel injector
5. Throttle body and injection ECU (MIU)
6. Diagnostics connector
7. Engine revolution sensor
8. Lambda probe
9. HV coil
10. Fuel pump
11. Fan
12. Injection relay
13. Fan relay

MIU injection system

This is an integrated ignition and injection system.

Injection is indirect in the manifold through an electro-injector.

Injection and ignition are timed on the 4-stroke cycle using a tone wheel keyed onto the crankshaft (24-2 teeth) and a reluctant variation (pick-up) sensor.

Carburetion and ignition are managed on the basis of the engine revs and throttle valve opening. Further corrections are made according to the following parameters:

- Coolant temperature
- Intake air temperature
- Lambda probe value

The system implements an idle supply correction with cold engine through a Stepper motor on a by-pass circuit of the throttle valve. The electronic control unit manages the Stepper motor and the injector opening time, thereby ensuring idle steadiness and proper carburetion.

In all conditions of use, carburetion is controlled by modifying the injector opening time.

Fuel delivery pressure is kept constant based on the ambient pressure.

The **fuel supply circuit** consists of:

- Fuel pump
- Fuel filter
- Injector
- Pressure regulator

Pump, filter and regulator are placed into the fuel tank using a single support.

The injector is connected by means of a pipe fitted with fast-release fittings. The pressure regulator is at the beginning of the circuit.

The fuel pump is controlled by the MIU control unit; therefore the scooter's safety is enhanced.

The **ignition circuit** consists of:

- HV coil
- HV cable
- Shielded cap
- MIU control unit
- Spark plug

The MIU control unit manages the ignition with the best advance ensuring 4-stroke timing (ignition only in the compression stroke) at the same time.

The MIU injection-ignition system controls engine functions by means of a pre-set program.

Should any input signals fail, an acceptable working order of the engine is ensured to allow the user to reach a service station.

Obviously, this cannot happen when the rev counter signal is missing, or when the failure concerns the control circuits:

- Fuel pump
- HV coil
- Injector

The control unit is fitted with a self-diagnosis system connected to a warning light on the instrument panel.



Failures are detected and restored by the diagnostic tester.



The MIU injection-ignition system carries out checks on the rpm indicator and the radiator cooling electric fan.

Precautions

1. Before fixing any part of the injection system, check to see if there are any registered faults. Check for faults before disconnecting the battery.
2. The fuel supply system is pressurised at 300 kPa (3 BAR). Before disconnecting the fast-release fitting of the fuel supply pipe, check that there are no naked flames. Do not smoke. Act with caution to prevent spraying fuel in your eyes.
3. When fixing electric components, operate with battery connected only when strictly required.
4. When checking functions, make sure that the battery voltage is over 12V
5. Before trying to start-up, check to make sure there is at least 2 litres of fuel in the tank. Failure to observe this procedure can damage the fuel pump.
6. If the scooter is not going to be used for a long time, refill the tank to a little over half its capacity. This ensures that the pump will be covered by fuel.
7. When washing the vehicle, do not press the electric components and wiring.
8. When an ignition fault is detected, proceed to check the battery and the injection system connections first.
9. Before disconnecting the MIU control unit connector, follow these steps respecting the order shown:
 - Set the switch to «OFF»
 - Disconnect the battery
 Failure to observe this rule can damage the electronic control unit.

10. Do not invert the polarity when fitting the battery.
11. In order to prevent damages, disconnect and reconnect the MIU system connectors only if actually required. Before restoring the connections, check that they are perfectly dry.
12. When carrying out electric inspections, do not force the tester probes into the connectors. Do not take measurements not specifically required by the manual.
13. At the end of every check carried out with the diagnostic tester, protect the system connector with the specific cap. Failure to observe this rule can damage the MIU electronic control unit.
14. Before reconnecting the fast-release fittings of the power supply system, check that the terminals are perfectly clean.

Troubleshooting tips

1 A failure of the MIU system is more likely to be due to the connections rather than the components.

Before searching the MIU system for failures, check:

A: Power supply

- a. Battery voltage
- b. If a fuse is blown
- c. Remote controls
- d. Connectors

B: Chassis ground connection

C: Fuel supply

- a. If the fuel pump is broken
- b. If the fuel filter is dirty

D: Ignition system

- a. If the spark plug is faulty
- b. If the coil is broken
- c. If the shielded cap is broken

E: Intake circuit

- a. If the air filter is dirty
- b. If the by-pass circuit is clogged
- c. If the Stepper motor is failing

F: Others

- a. If the timing system is not correctly adjusted
- b. If the idle carburetion is not correct
- c. If the throttle valve position sensor is not correctly reset

2 MIU system failure may be caused by loose connectors. Make sure that all connections are properly implemented.

Check the connectors as follows:

A check that the terminals are not bent.

B check that the connectors have been properly connected.

C see whether the malfunction can be fixed by slightly shaking the connector.

3 Check the entire system carefully before replacing the MIU control unit. If the fault is still present after the MIU control unit is replaced, install the original control unit again and check whether the fault occurs again.

4 Use a multimeter with an internal resistance over 10K Ohm /V when troubleshooting. Do not use unsuitable instruments as they may damage the MIU control unit. Instruments with definitions over 0.1V and 0.5 W must be used. Precision must be greater than 2%.

Terminals setup

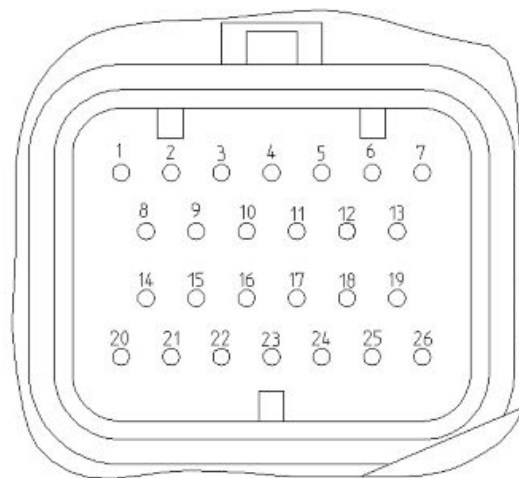

TERMINAL LAYOUT

	Specification	Desc./Quantity
1	Injection warning light	
2	-	
3	-	
4	- lambda probe	
5	+ live battery	
6	+ Battery	
7	-	
8	Electric fan remote control	
9	Water Temperature Sensor	
10	-	
11	+ lambda probe	
12	Engine stop switch	
13	Engine revolution sensor (+)	
14	Fuel injector	
15	Engine revolution sensor (-)	
16	Diagnosis output	
17	-	
18	side stand	
19	-	
20	Injection load remote control	
21	-	
22	HV coil	

Specification	Desc./Quantity
23	-
24	Start-up enabling
25	Fall sensor
26	Ground connection

EMS circuit diagram

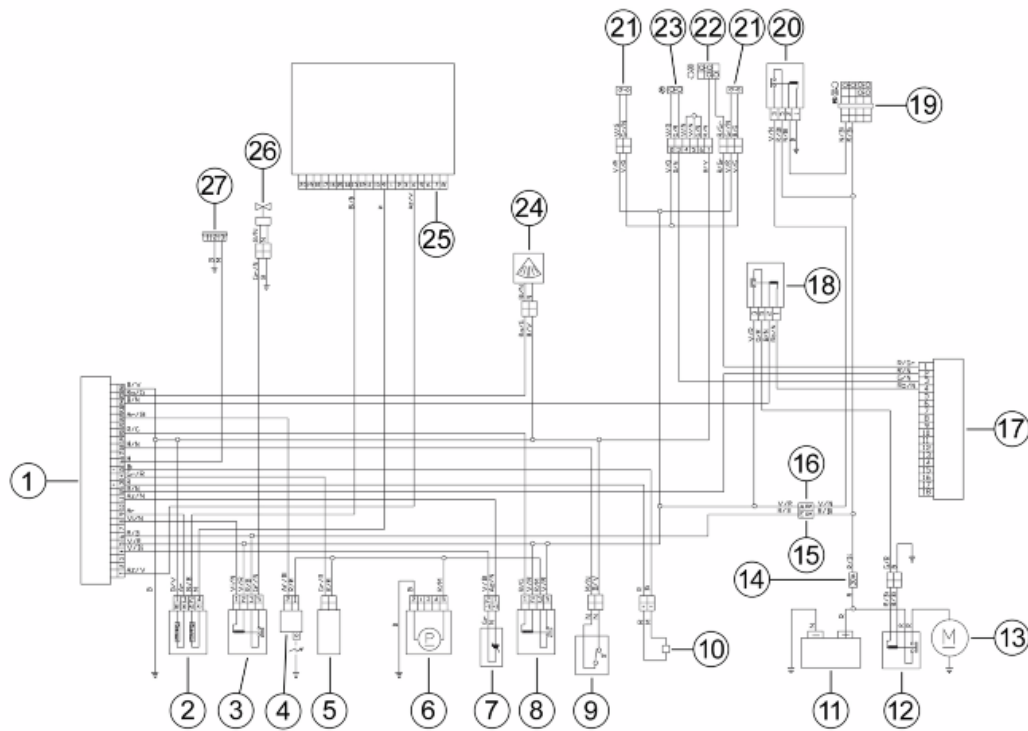

SYSTEM DIAGRAM

Specification	Desc./Quantity	
1	Injection electronic control unit	
2	Water Temperature Sensor	
3	Electric fan remote control	
4	HV coil	
5	Fuel injector	
6	Fuel pump	
7	Lambda Probe	
8	Injection load remote control	
9	stand switch	
10	Engine revolution sensor	
11	Battery	
12	Start-up remote control	
13	Starter motor	
14	Fuse	30 A
15	Fuse	10 A
16	Fuse	15 A
17	Antitheft control unit	
18	Start-up remote control relay	
19	Key switch contacts	
20	Key switch relay	

	Specification	Desc./Quantity
21	Stop switch	
22	Engine stop switch	
23	Starter button	
24	Fall sensor	
25	Instrument panel	
26	Electric fan	
27	Connector for diagnosis	

Troubleshooting procedure

Engine does not start

ENGINE DOES NOT START EVEN IF PULLED

Possible Cause	Operation
Faults detected by self-diagnosis	Pump relay HV coil Injector Revolution timing sensor
Fuel supply	Fuel present in the tank Fuel pump activation Fuel pressure (low) Injector flow (low)
Power to the spark plug	Spark plug Shielded cap - HV Coil (secondary insulation)
Parameter reliability	Coolant temperature Distribution timing - injection start Intake air temperature
End of compression pressure	End of compression pressure
Parameter reliability	Coolant temperature Distribution timing - injection start Intake air temperature

Starting difficulties

ENGINE START-UP PROBLEMS

Possible Cause	Operation
Faults detected by self-diagnosis	Pump relay HV coil Injector Revolution timing sensor Air temperature Coolant temperature
Start-up speed	Starter motor and remote control Battery Ground connections
End of compression pressure	End of compression pressure
Power to the spark plug	Spark plug Shielded cap HV coil Revolution timing sensor

Possible Cause	Operation
	Ignition advance
Fuel supply	Fuel pressure (low) Injector flow (low) Injector seal (poor)
Correctness of the parameters	Coolant temperature Intake air temperature Stepper throttle valve position (steps and actual opening) Cleaning the auxiliary air pipe and air filter efficiency throttle valve

Engine stops at idle

ENGINE DOES NOT HOLD IDLING/ IDLING IS UNSTABLE/ IDLING TOO LOW

Possible Cause	Operation
Faults detected by self-diagnosis	Pump relay HV coil Injector Revolution timing sensor Air temperature Coolant temperature
Ignition efficiency	Spark plug Ignition timing
Correctness of the parameters	Throttle valve position sensor Stepper Coolant temperature sensor Intake air temperature sensor
Intake system cleaning	Air filter Diffuser and throttle valve Supplementary air pipe and Stepper
Intake system seal (seepage)	Intake manifold - head Throttle body - manifold Intake manifold Filter housing
Fuel supply (low pressure)	Fuel pump Pressure regulator Fuel filter Injector flow

Engine does not rev down

ENGINE DOES NOT RETURN TO IDLING/IDLING TOO HIGH

Possible Cause	Operation
Faults detected by self-diagnosis	Pump relay HV coil Injector Revolution timing sensor Air temperature Coolant temperature
Ignition efficiency	Ignition timing
Correctness of the parameters	Throttle valve position sensor Stepper

Possible Cause	Operation
Intake system seal (seepage)	Coolant temperature sensor
	Intake air temperature sensor
Fuel supply (low pressure)	Intake manifold - head
	Throttle body - manifold
	Intake manifold
	Filter housing
	Fuel pump
	Pressure regulator
	Fuel filter
	Injector flow

Exhaust backfires in deceleration

EXHAUST BACKFIRING WHEN DECELERATING

Possible Cause	Operation
Faults detected by self-diagnosis	Pump relay
	HV coil
	Injector
	Revolution timing sensor
	Air temperature
	Coolant temperature
	Lambda Probe
Correctness of the parameters	Throttle valve position sensor
	Stepper
	Coolant temperature sensor
	Intake air temperature sensor
Intake system seal (seepage)	Intake manifold - head
	Throttle body - manifold
	Intake manifold
	Filter housing
Fuel supply (low pressure)	Fuel pump
	Pressure regulator
	Fuel filter
	Injector flow
Exhaust system seal (seepage)	Manifold - head
	Manifold - muffler
	Muffler welding

Engine revs irregularly

REGULAR ENGINE PROGRESS WITH VALVE SLIGHTLY OPEN

Possible Cause	Operation
Intake system cleaning	Air filter
	Diffuser and throttle valve
	Supplementary air pipe and Stepper
Intake system seal	Intake manifold
	Filter housing
Ignition system	Spark plug wear check
Parameter reliability	Throttle valve position signal
	Coolant temperature signal
	Intake air temperature signal

Possible Cause	Operation
	Ignition advance
TPS reset successful	TPS reset successful
Faults detected by self-diagnosis	Pump relay HV coil Injector Revolution timing sensor Air temperature Coolant temperature Lambda Probe

Poor performance at full throttle

POOR ENGINE PERFORMANCE AT FULL POWER/ IRREGULAR ENGINE PROGRESS ON ACCELERATION

Possible Cause	Operation
Faults detected by self-diagnosis	Pump relay HV coil Injector Revolution timing sensor Air temperature Coolant temperature Lambda Probe
Power to spark plug	Spark plug Shielded cap HV Cable HV Coil
Intake system	Air filter Filter housing (seal) Intake sleeve (seal)
Parameter reliability	Throttle valve position signal Coolant temperature signal Intake air temperature signal Ignition advance
Fuel supply	Fuel level in the tank Fuel pressure Fuel filter Injector flow

Engine knocking

PRESENCE OF KNOCKING (COMBUSTION SHOCKS)

Possible Cause	Operation
Faults detected by self-diagnosis	Pump relay HV coil Injector Revolution timing sensor Air temperature Coolant temperature Lambda Probe
Ignition efficiency	Spark plug
Parameter reliability	Throttle valve position signal

Possible Cause	Operation
	Coolant temperature signal Intake air temperature signal Ignition advance
Intake system seal	Intake manifold Filter housing
TPS reset successful Fuel supply	TPS reset successful Fuel pressure Fuel filter Injector flow Fuel quality
Selecting the thickness for the cylinder base gas- ket	Selecting the thickness for the cylinder base gas- ket

Fuel supply system

The fuel supply circuit includes the electric pump, the filter, the pressure regulator, the electro-injector and the fuel delivery pipe.

The electrical pump is located in the tank from which the fuel is pumped and sent to the injector through the filter.

The pressure is controlled by the pressure regulator situated in the pump assembly in the tank.

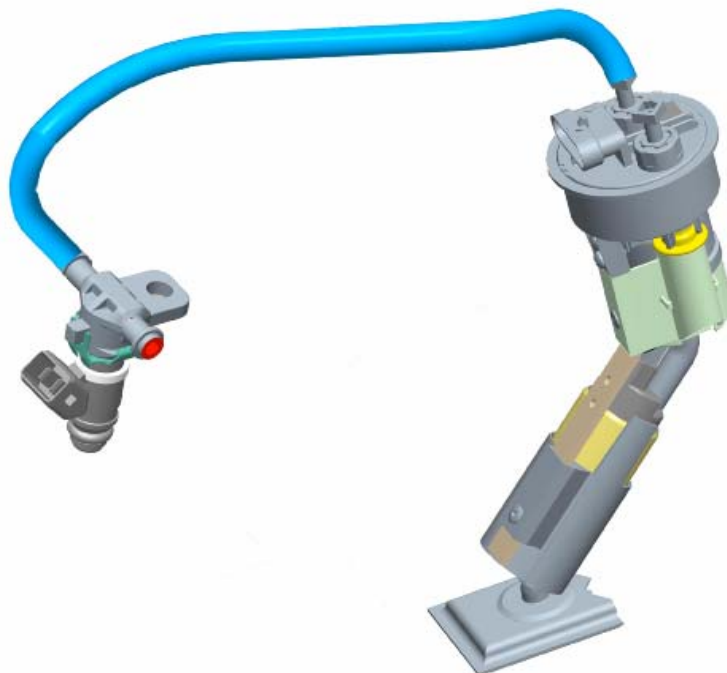

Removing the butterfly valve

- Remove the fuel piping fixing screw indicated in the figure.

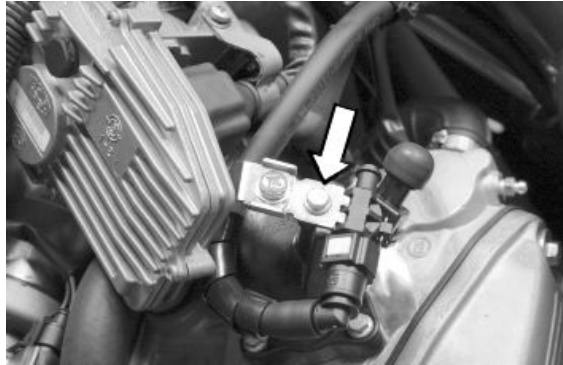

- Remove the fast-release fitting from the injector support.

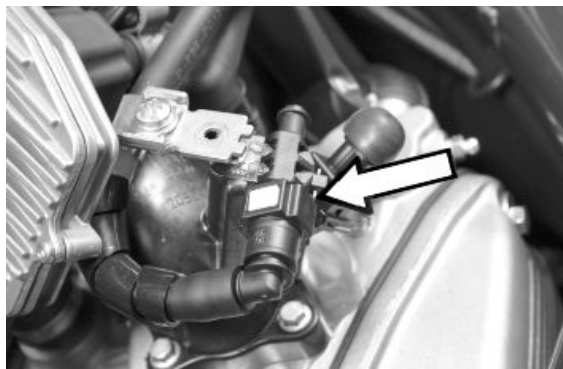

- Remove the injector connector.

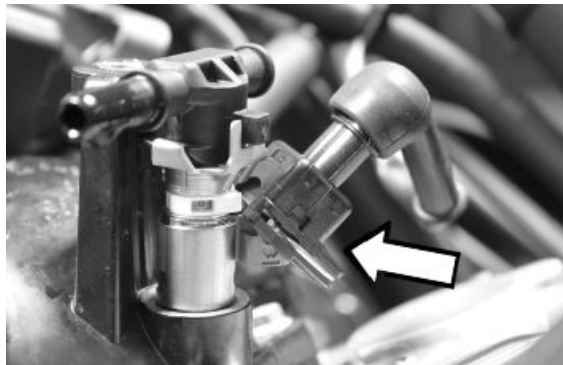

- Remove the three screws fixing the manifold to the cylinder head and the clamp fixing the throttle body to the manifold.

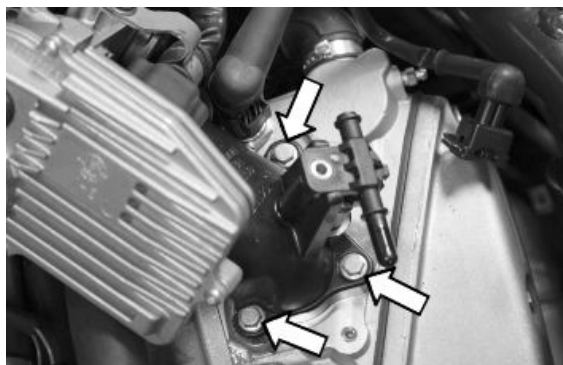



- Remove the MIU control unit connector

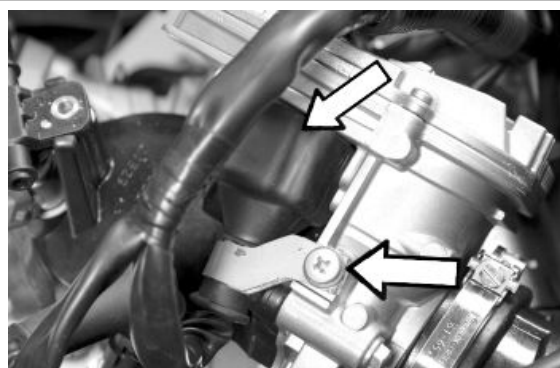

- Remove throttle control retainer.

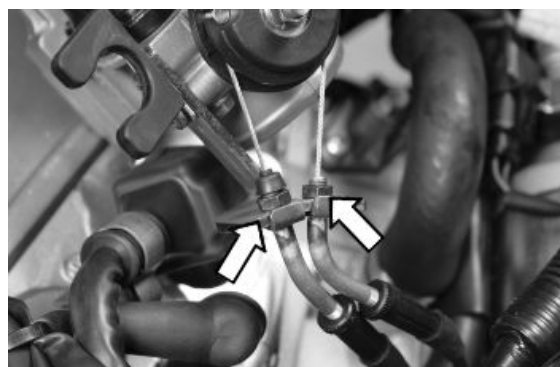

Pump supply circuit

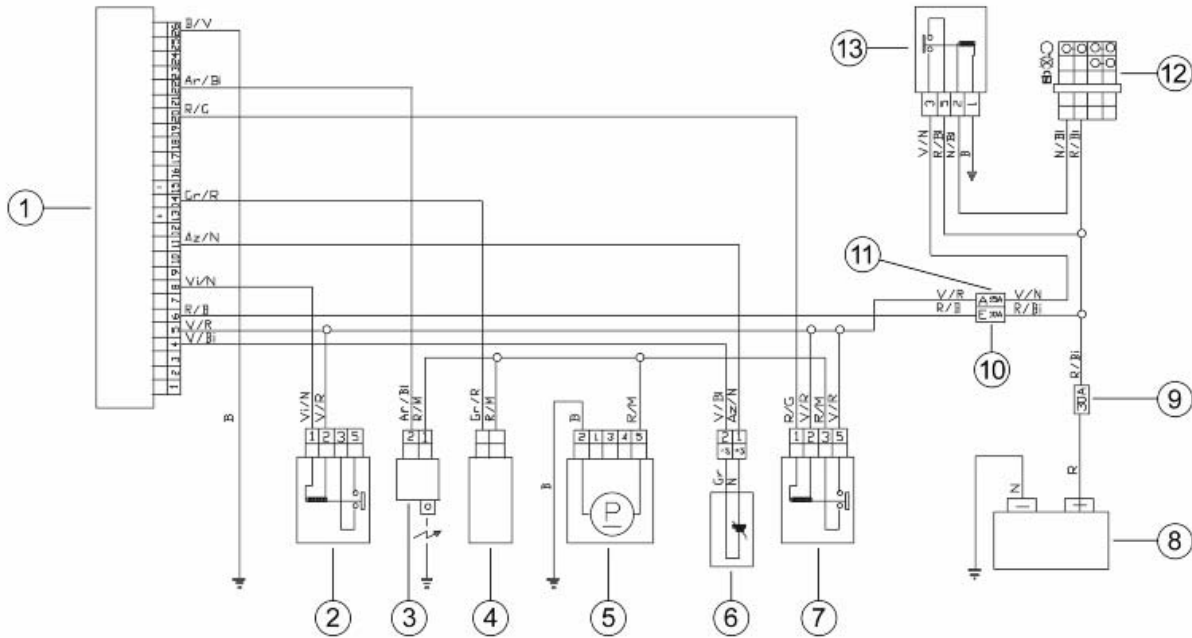

INJECTION LOAD

	Specification	Desc./Quantity
1	Injection electronic control unit	
2	Electric fan remote control	
3	HV coil	
4	Fuel injector	
5	Fuel pump	
6	Lambda Probe	
7	Injection load remote control	
8	Battery	
9	Fuse	30 A
10	Fuse	10 A
11	Fuse	15 A
12	Key switch contacts	
13	Key remote control switch relay	

When switched to "ON", the fuel pump starts to rotate for 2 seconds and then stops. With engine on and when a revolution timing signal is displayed, the pump is continuously supplied.

ELECTRICAL DATA

- Pump winding resistance ~ 0.8 Ohm
- Input current during regular functioning ~ 2.8 A

Check the efficiency of the 15A fuse «A».



Check the efficiency of the injection load remote control: Check the resistance of the drive coil between pins 86 and 85: 40 ÷ 80 Ohm.

Apply a voltage of 12V to pins 86 and 85; make sure that there is continuity between pins 30 and 87 of the remote control.



Check the power supply line of the injection load remote control drive coil: upon switching to "ON", make sure there is battery voltage for 2 seconds between the Red-Yellow cable and the Green-Red cable of the remote control base. If there is none, check the continuity of the Green-Red cable between the fuse box and the remote control base and check the continuity of the Red-Yellow cable between pin 20 of the control unit and the remote control base.

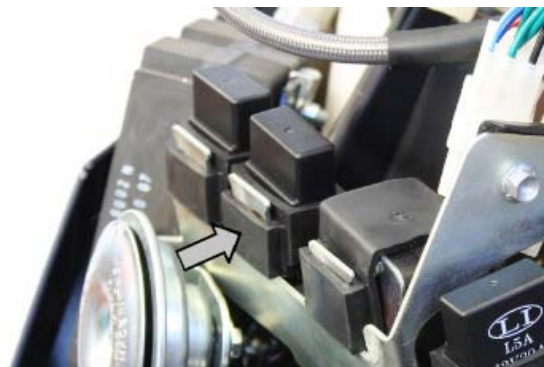

NOTE

CONTINUITY TESTS MUST BE CARRIED OUT WITH THE COMPONENTS DISCONNECTED. (BATTERY, REMOTE CONTROL SWITCHES, CONTROL UNIT, FUSES, ETC.).

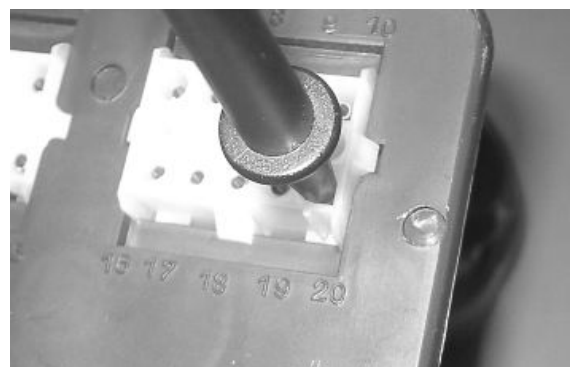

Check there is voltage between the Green-Red cable of the remote control base and the ground lead.



Upon switching to "ON", check that there is battery voltage for about two seconds between the Red-Brown cable of the pump connector and ground connection, with the pump connector disconnected. Otherwise, check the continuity of the Red-Brown cable between the pump connector and the remote control base.



Check the efficiency of the ground line of the fuel pump by measuring the continuity between the pump connector Blue cable, system side, and the ground connection.

If, upon switching to "ON", the pump continues to turn 2 seconds after activation, check, with both the control unit and the injection load remote control disconnected, that the Red-Yellow cable (pin 20 on the interface wiring) is insulated from the ground connection.

Specific tooling

020331Y Digital multimeter

Circuit leak test

Install the appropriate tool to check fuel pressure with the pipe fitted with a pressure gauge.

Checking under regular functioning by placing the specific tool between the pump and the injector.

With >12V battery voltage, check that the fuel pressure is 3 BAR and that the input current is ~2.8

A



With the >12V battery voltage, check the pump flow rate by disconnecting the pipe fitted with the pressure gauge of the appropriate tool from the injector. Place a graded burette with a flow rate of approximately 1 L. Make the pump turn with the active diagnosis on the palm top computer. Using a pair of long flat needle-nose pliers, choke the fuel pipe making the pressure stabilise at approx. $2.9 \div 3$ BAR. Be careful not to further choke the pipe since the pressure remains equal to 3 BAR while the capacity decreases. Check that, within 15 seconds, the pump has a flowrate of approx. 300 cm^3 .

Specific tooling

020480Y Fuel pressure check kit

Fuel filter check

Disconnect the terminals of the electrical pump



Remove the screw indicated in the photograph

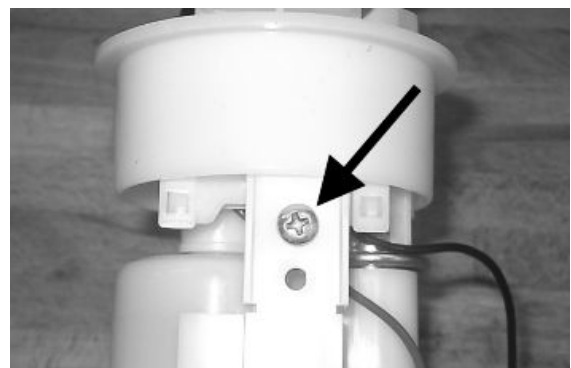

Remove the clip fixing the piping to the filter shown in the photograph



Separate the lower part of the pump support as shown in the photograph.

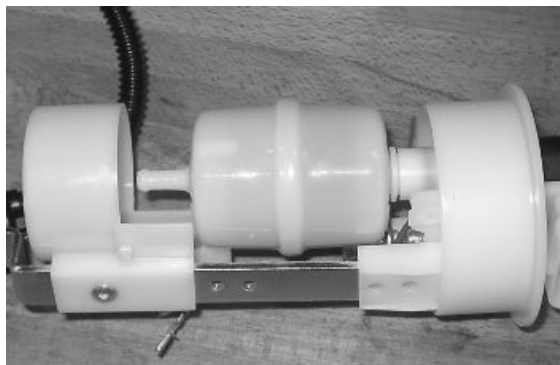

Remove the filter from the pump support

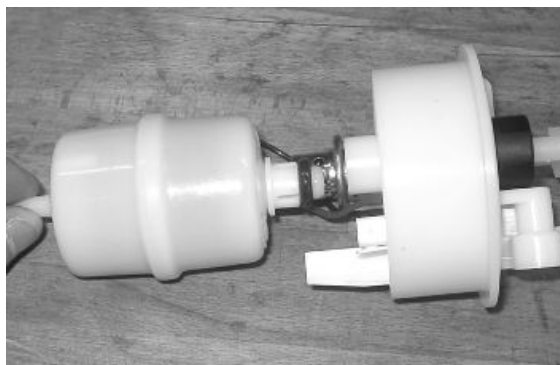

Check the efficiency of the 15A fuse «A».

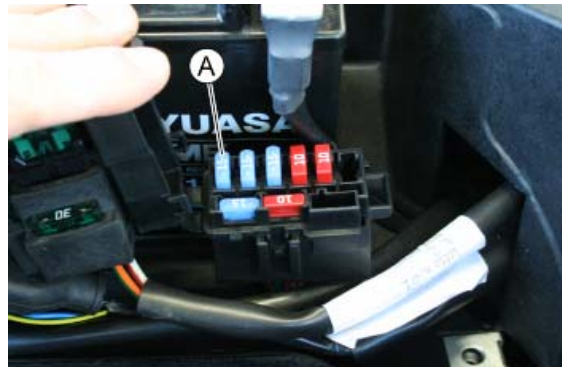

Check the efficiency of the injection load remote control: Check the resistance of the drive coil between pins 86 and 85: 40 ÷ 80 Ohm.

Apply a voltage of 12V to pins 86 and 85; make sure that there is continuity between pins 30 and 87 of the remote control.



Check the power supply line of the injection load remote control drive coil: upon switching to "ON", make sure there is battery voltage for 2 seconds between the Red-Yellow cable and the Green-Red cable of the remote control base. If there is none, check the continuity of the Green-Red cable between the fuse box and the remote control base and check the continuity of the Red-Yellow cable between pin 20 of the control unit and the remote control base.

NOTE

CONTINUITY TESTS MUST BE CARRIED OUT WITH THE COMPONENTS DISCONNECTED. (BATTERY, REMOTE CONTROL SWITCHES, CONTROL UNIT, FUSES, ETC.).

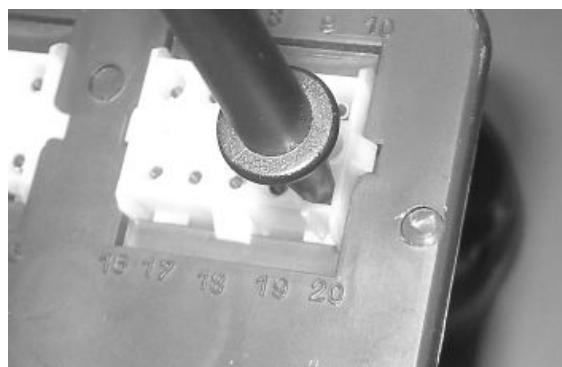
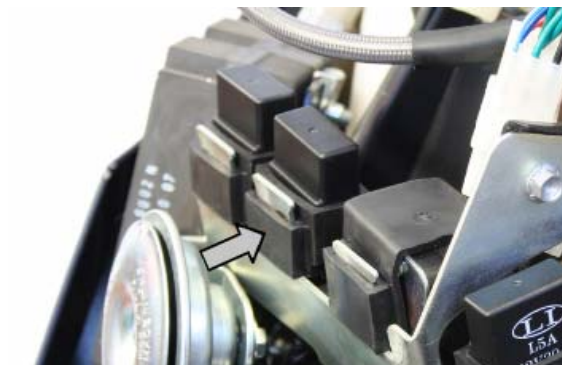

Check there is voltage between the Green-Red cable of the remote control base and the ground lead.



With both the control unit and the injector disconnected, check the continuity of the Grey-Red cable between pin 14 of the interface wiring and the injector connector.



Upon switching to "ON" and with the injector disconnected and the control unit connected, check there is voltage between the Red-Brown cable of the injector connector and the ground connection.

With injector disconnected and the injector load remote control disconnected, check the continuity of the Red-Brown cable between the injector connector and remote control base.



Inspecting the injector hydraulics

To check the injector, remove the intake manifold by taking out the three fixing screws at the head and the three others connecting the control unit to the manifold.

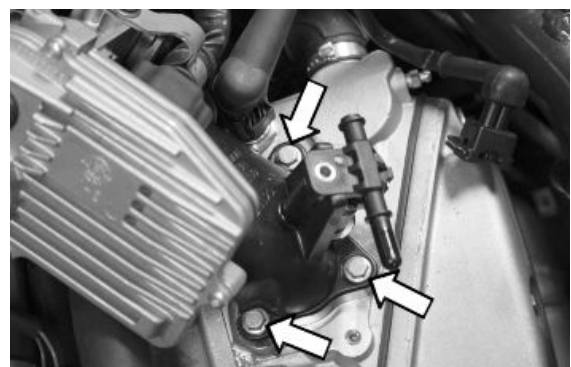

Fit the appropriate tool to check fuel pressure and position the manifold over a graded container, with a minimum capacity of 100 cm³. Connect the injector with the cable that is part of the components supplied for the injection tester. Connect the cable terminals to an auxiliary battery. Activate the fuel pump with the active diagnosis. Check that, within 15 seconds, approx. 70 cm³ of fuel is delivered at a regulation pressure of about 3 BAR.

Specific tooling

020480Y Fuel pressure check kit

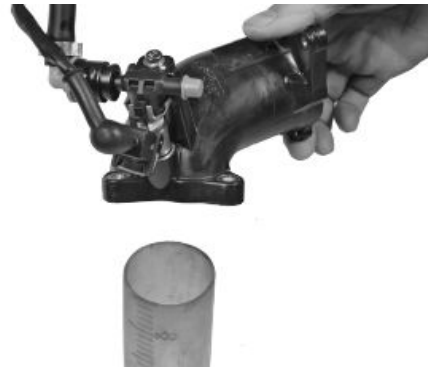

Carry out the injector sealing test

Dry the injector outlet with a blast of compressed air. Activate the fuel pump. Wait for one minute and make sure there are no leaks coming from the injector. Slight oozing is normal.

Limit value = 1 drop per minute

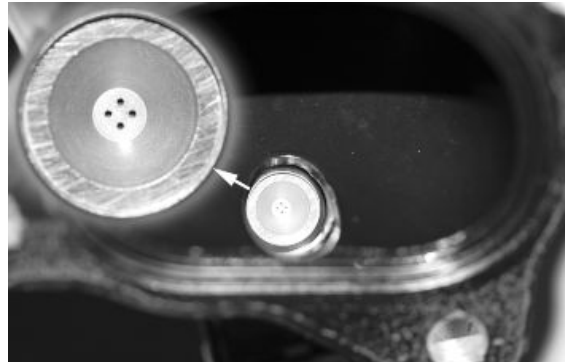

Tachometer

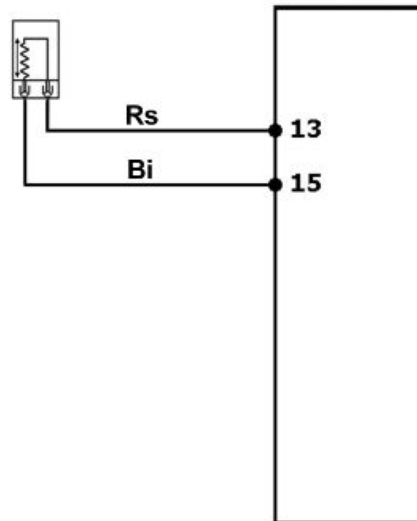

With the wiring disconnected from the control unit and connected to the system, check that the sensor resistance between pins 13 - 15 is between 100 and 150 Ohm at an engine temperature of about 20°

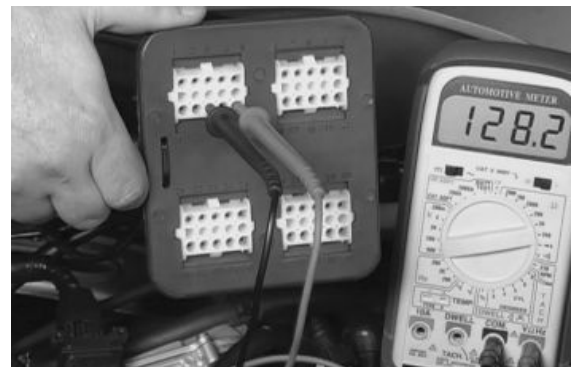

Disconnect the fuel pump connector. Start the engine and wait for it to stop. With the wiring connected to the control unit and the system, try to start-up the engine and check that the voltage between pins 13 and 15 is approx. 2.8 V ~



With the interface wiring disconnected from the control unit, check continuity between pin 13 and the Red cable of the rpm sensor connector and between pin 15 and the White cable of the rpm sensor connector.



With the interface wiring disconnected from the control unit and the rpm sensor connector also disconnected, check that the Red and White cables (pin 13 - 15) are insulated from each other and insulated from the ground connection.

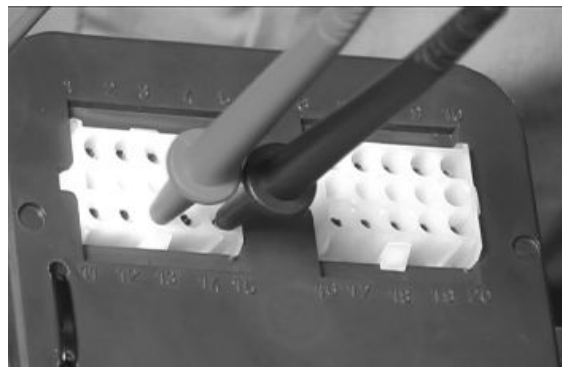

Specific tooling

020481Y Adaptor cable harness

020331Y Digital multimeter

HT coil

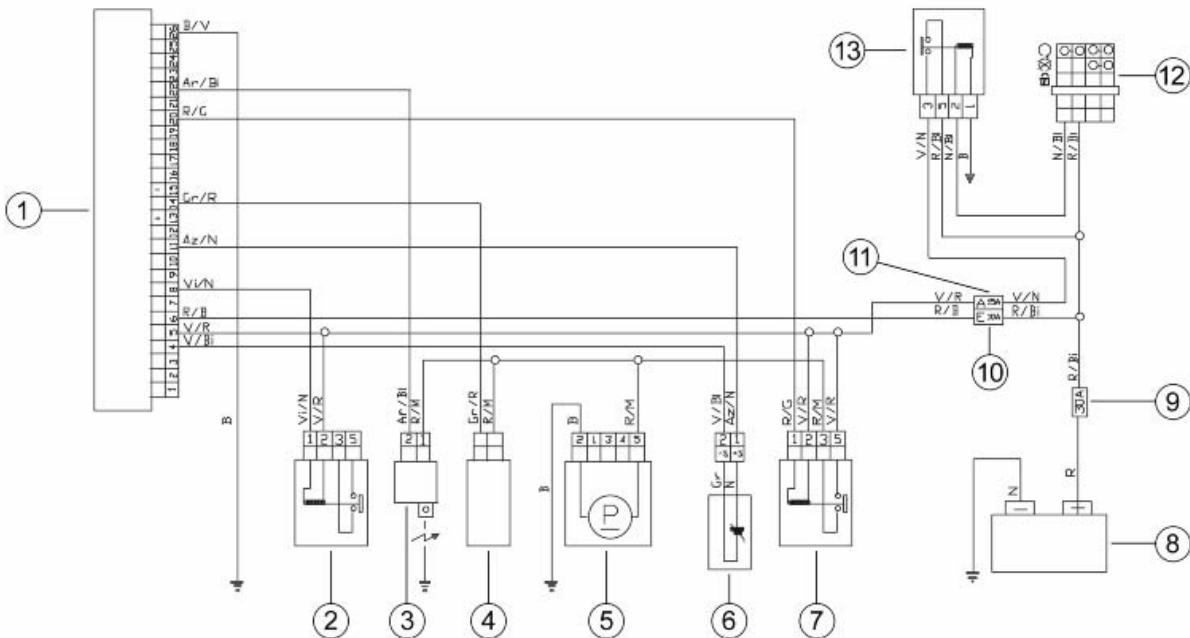

INJECTION LOAD

	Specification	Desc./Quantity
1	Injection electronic control unit	

	Specification	Desc./Quantity
2	Electric fan remote control	
3	HV coil	
4	Fuel injector	
5	Fuel pump	
6	Lambda Probe	
7	Injection load remote control	
8	Battery	
9	Fuse	30 A
10	Fuse	10 A
11	Fuse	15 A
12	Key switch contacts	
13	Key remote control switch relay	

The combined ignition/injection system is a high-efficiency induction system.

The control unit manages two significant parameters:

- Ignition advance

This is optimised at once according to the engine revs, engine load, temperature and ambient pressure.

With engine at idle speed, it is optimised to stabilise the speed at 1500 ± 100 rpm.

- Magnetisation time

The coil magnetisation time is controlled by the control unit. The power of the ignition is increased during the engine start-up phase.

The injection system recognises the 4-stroke cycle so ignition is only commanded in the compression phase.

Specific tooling

020331Y Digital multimeter

Check the efficiency of the 15A fuse «A».



Check the efficiency of the injection load remote control: Check the resistance of the drive coil between pins 86 and 85: $40 \div 80$ Ohm.

Apply a voltage of 12V to pins 86 and 85; make sure that there is continuity between pins 30 and 87 of the remote control.



Check the power supply line of the injection load remote control drive coil: upon switching to "ON", make sure there is battery voltage for 2 seconds between the Red-Yellow cable and the Green-Red cable of the remote control base. If there is none, check the continuity of the Green-Red cable between the fuse box and the remote control base and check the continuity of the Red-Yellow cable between pin 20 of the control unit and the remote control base.

NOTE

CONTINUITY TESTS MUST BE CARRIED OUT WITH THE COMPONENTS DISCONNECTED. (BATTERY, REMOTE CONTROL SWITCHES, CONTROL UNIT, FUSES, ETC.).

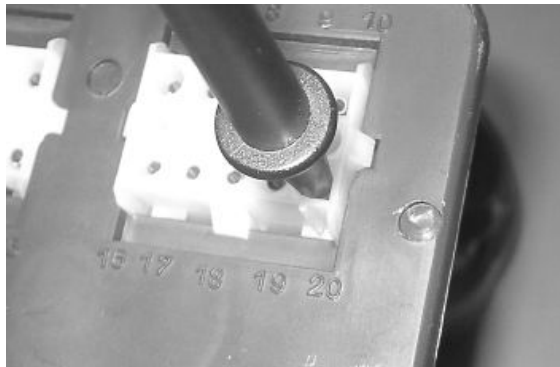
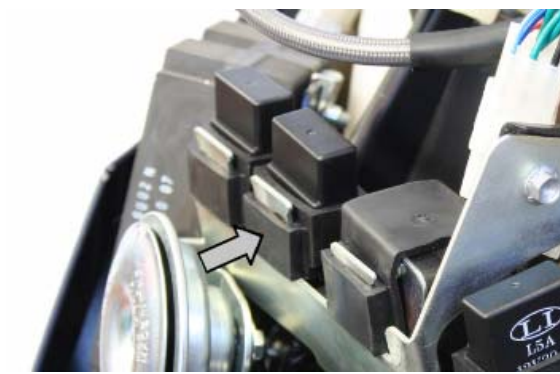

Check there is voltage between the Green-Red cable of the remote control base and the ground lead.



Check there is voltage between pins 22 and 26 of the interface wiring for around two seconds upon switching to "ON"

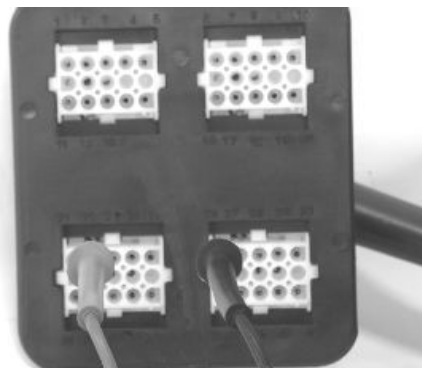

Check the resistance of the coil primary between pin 22 of the interface wiring and the Red-Brown cable of the injection load remote control base, with both the control unit and the remote control disconnected.

Electric characteristic**Resistance of the primary**

~ 1 Ohm

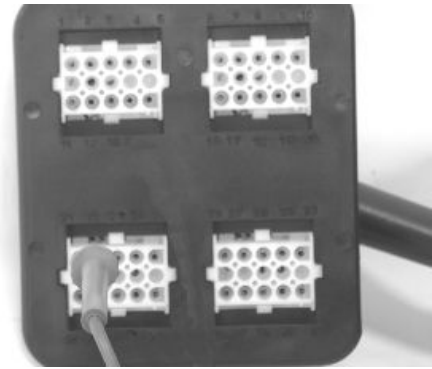
**Inspecting the spark plug shielded cap**

Measure the shielded cap resistance.

Electric characteristic**Resistance:**

5 K Ω

If different values are measured (<1; >20K Ω), replace the shielded cap.

**NOTE**

**A SHIELDLESS SPARK PLUG CAP OR A MISSING SPARK PLUG CAN ADVERSELY AFFECT THE INJECTION SYSTEM.
FOR INFORMATION ON SPARK PLUGS, SEE THE «SPECIFICATIONS» AND «MAINTENANCE» CHAPTERS.**

Spark advance

The ignition advance is determined electronically on the basis of parameters known by the control unit. For this reason it is not possible to state the reference values based on the engine revs.

The ignition advance value can be measured at any time with the diagnostic tester.

It is possible to check whether the ignition advance determined by the injection system does in fact correspond with the value actually activated on the engine, by means of the stroboscopic light.

Proceed as follows:

- Remove the external transmission cover as described in the «Automatic transmission» chapter.



- Remove the cap to inspect the TDC reference found between the flywheel and cover housing. See «Flywheel cover» chapter.



- Acting on the driving pulley nut, turn the engine until the references to determine the TDC are found.



- Repeat for the reference between the driving pulley and the transmission cover.



- Refit the inspection cap on the flywheel side.
- Connect the diagnostic tester.
- Start the engine.
- Select the «parameter» function from the menu.
- Select the stroboscopic light control in the traditional four-stroke engine position (1 spark, 2 revs).
- Check that the real values of revs and ignition advance match those measured using the diagnostic tester.



If the values do not correspond, check:

- distribution timing
- rpm timing sensor
- injection control unit

Coolant temperature sensor

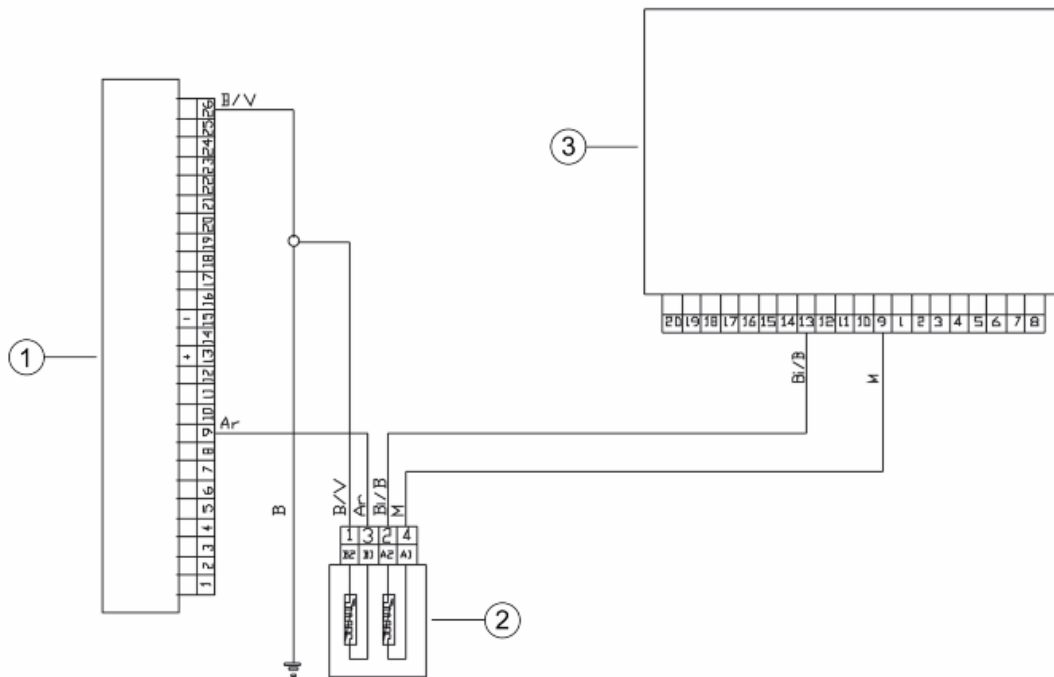

TEMPERATURE SENSOR

	Specification	Desc./Quantity
1	control unit	
2	Water Temperature Sensor	
3	Instrument panel	

With the control unit-side connector disconnected and the coolant temperature sensor connector connected, check the resistance values between pin 9 and the ground connection match the engine temperature.

$20^{\circ} = 2500 \pm 100 \Omega$

$80^{\circ} = 308 \pm 6 \Omega$

With the control unit-side connector disconnected and the coolant temperature sensor connector also disconnected, check the insulation between the Orange and the ground connection.

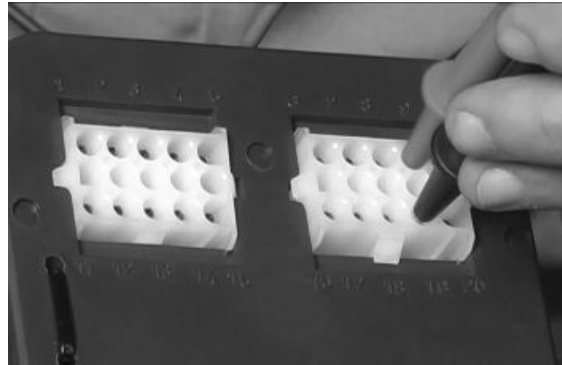

With the control unit-side connector disconnected and the coolant temperature sensor connector also disconnected, check the continuity between pin 9 of the interface wiring and the Orange cable of the connector.

Specific tooling

020481Y Adaptor cable harness

020331Y Digital multimeter

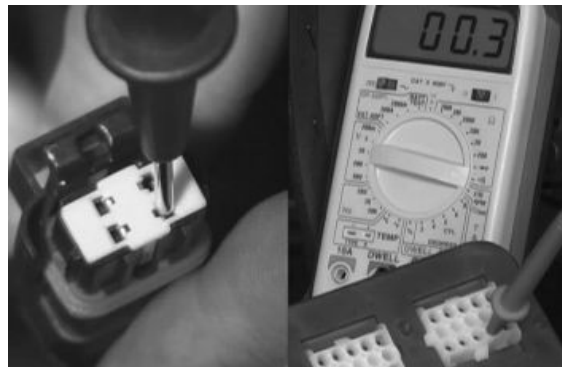

Zeroing the throttle

Throttle valve position signal reset (TPS reset)

The MIU control unit is supplied with throttle valve position sensor and is pre-calibrated.

Pre-calibration entails regulating the minimum opening of the throttle valve to obtain a specific air flow under pre-set reference conditions.

Pre-calibration ensures optimal air flow for the control of the idle speed.

This regulation must not be tampered with in any way whatsoever.

The injection system will complete the management of the idling through the Stepper and the variation of the ignition advance.

After the pre-calibration the throttle body has an open valve with a variable angle depending on the tolerances of the machining of the pipe and the valve itself.

The valve position sensor can also have various fitting positions. For these reasons the mVs of the sensor with the valve at idle can vary from one throttle body to another.

To obtain the optimum carburetion, especially at small openings of the throttle valve, it is essential to match the throttle body with the control unit following the procedure known as TPS resetting.

With this operation we inform the control unit, as a starting point, of the mV value corresponding to the pre-calibrated position.

To reset, proceed as follows.

Connect the diagnostic tester.

Shift to «ON».

Select the diagnostic tester functions on «**THROTTLE POSITION AUTODETECTION**».



Make sure that the throttle valve control is in contact with the stop screw.

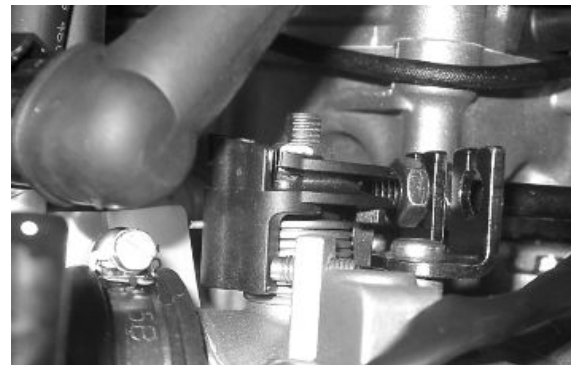

Guaranteeing that this position will be kept, give the confirmation for the TPS reset procedure.

Reset should be performed in the following cases:

- on first fitting.
- if the injection control unit is replaced.

NOTE

THE TPS RESETTING PROCEDURE MUST NOT BE CARRIED OUT WITH A USED THROTTLE BODY BECAUSE POSSIBLE VALVE WEAR AND STOP WEAR FOR THE MINIMUM OPENING MAKE THE AIR FLOW DIFFERENT FROM THAT OF THE PRE-CALIBRATION.

Lambda probe

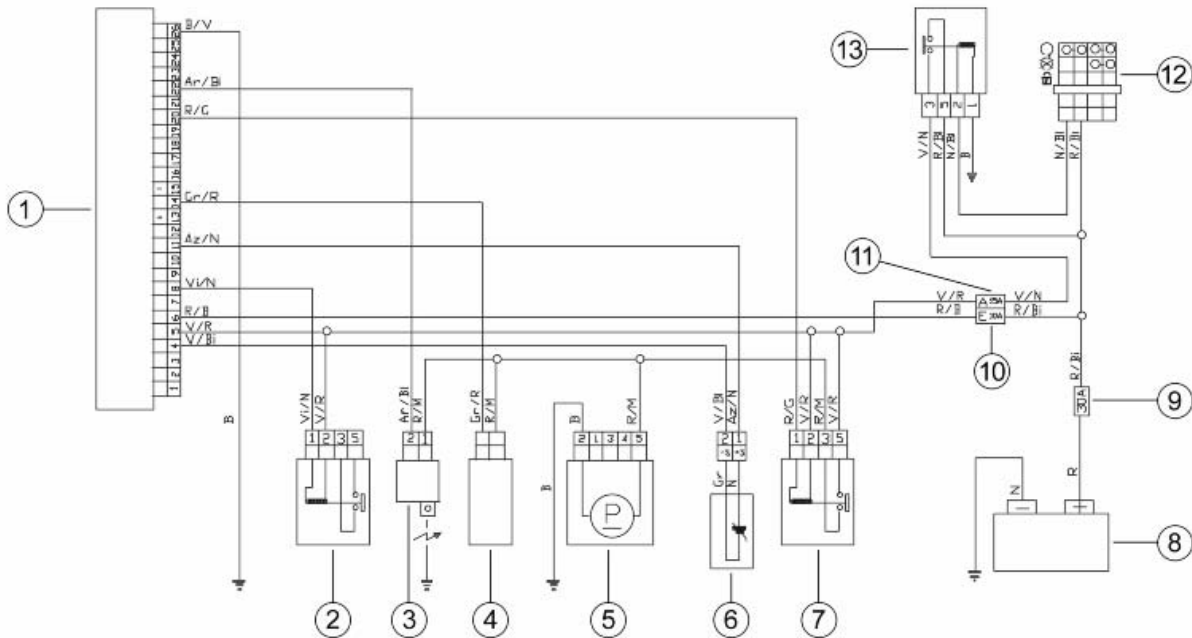

INJECTION LOAD

	Specification	Desc./Quantity
1	Injection electronic control unit	
2	Electric fan remote control	
3	HV coil	
4	Fuel injector	
5	Fuel pump	
6	Lambda Probe	
7	Injection load remote control	
8	Battery	
9	Fuse	30 A
10	Fuse	10 A
11	Fuse	15 A
12	Key switch contacts	
13	Key remote control switch relay	

The lambda probe or oxygen sensor is a sensor which provides information about the oxygen content in the exhaust fumes. The signal generated is not of the proportional but of the ON/OFF type, i.e. whether there is oxygen or not. The probe is positioned on the exhaust manifold before the catalytic converter in an area where the gas temperature is always high. The temperature at which the probe works is at least 350°C at 600°C and it has a reaction time of just 50 milliseconds. The signal generated passes from a high value to a low one with a mixture with lambda = 1.

Specific tooling

020481Y Adaptor cable harness

020331Y Digital multimeter

Check the efficiency of the 15A fuse «A».



Check the efficiency of the injection load remote control: Check the resistance of the drive coil between pins 86 and 85: 40 ÷ 80 Ohm.

Apply a voltage of 12V to pins 86 and 85; make sure that there is continuity between pins 30 and 87 of the remote control.



Check the power supply line of the injection load remote control drive coil: upon switching to "ON", make sure there is battery voltage for 2 seconds between the Red-Yellow cable and the Green-Red cable of the remote control base. If there is none, check the continuity of the Green-Red cable between the fuse box and the remote control base and check the continuity of the Red-Yellow cable between pin 20 of the control unit and the remote control base.

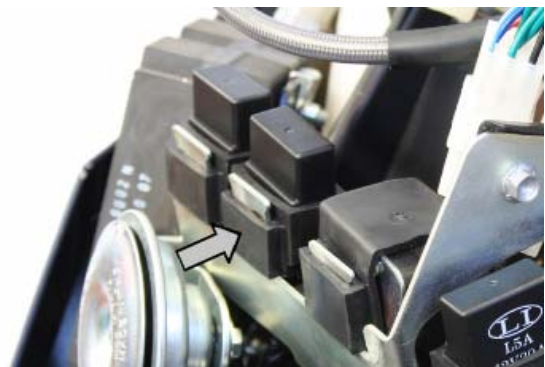

NOTE

CONTINUITY TESTS MUST BE CARRIED OUT WITH THE COMPONENTS DISCONNECTED. (BATTERY, REMOTE CONTROL SWITCHES, CONTROL UNIT, FUSES, ETC.).

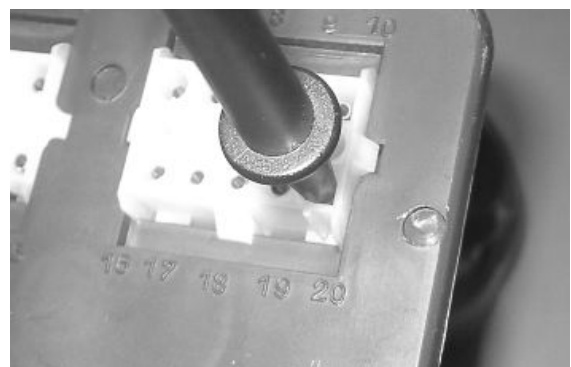

Check there is voltage between the Green-Red cable of the remote control base and the ground lead.



Install the electronic control unit interface wiring. Start the engine and warm it up until the electric fan switches on.

Use an analogue multimeter with a direct voltage scale measuring down to 2V.

Place the multimeter probes between pins 4 (-) and 11 (+)

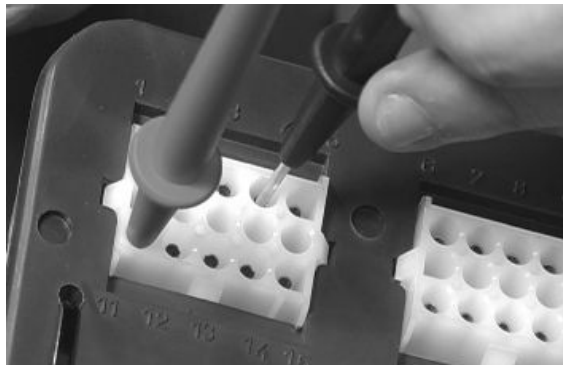

With the engine running at idle speed, check that the voltage oscillates between 0V and 1V

With the throttle valve fully open, the voltage is ~ 1V.

During the closing phase, the voltage is ~ 0V.

If the voltage remains constant, the sensor may be damaged. Remove the sensor and check that there are no oil or carbon deposits in it.

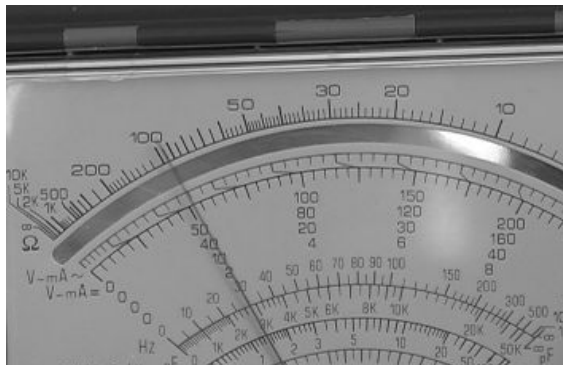

INDEX OF TOPICS

SUSPENSIONS

SUSP

Front

Front fork diagram

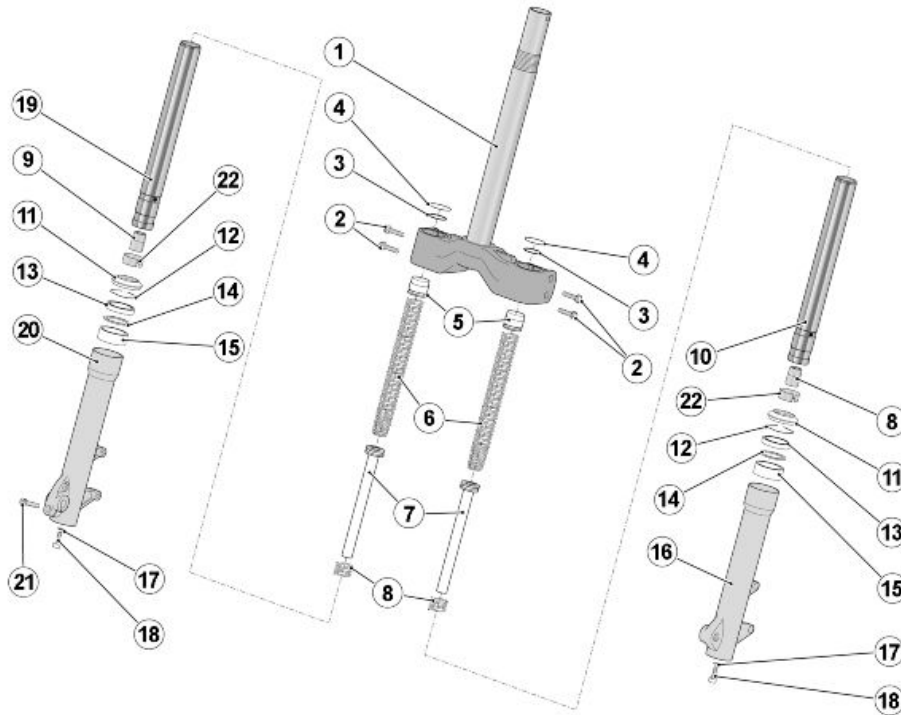

Key:

- 1. Fork base
- 2. Fork clamp screws
- 3. O-Ring
- 4. Circlip
- 5. Sealing cap
- 6. Spring
- 7. Pumping member
- 8. Counter spring
- 9. End stop buffer
- 10. Left stem
- 11. Dust guard gasket
- 12. Safety circlip
- 13. Sealing gasket
- 14. Cap
- 15. Bushing
- 16. Left wheel holder
- 17. Sealing washer

- 18. Lower screw
- 19. Right stem
- 20. Right wheel holder
- 21. Locking screw
- 22. Sliding bushing

Removing the front wheel

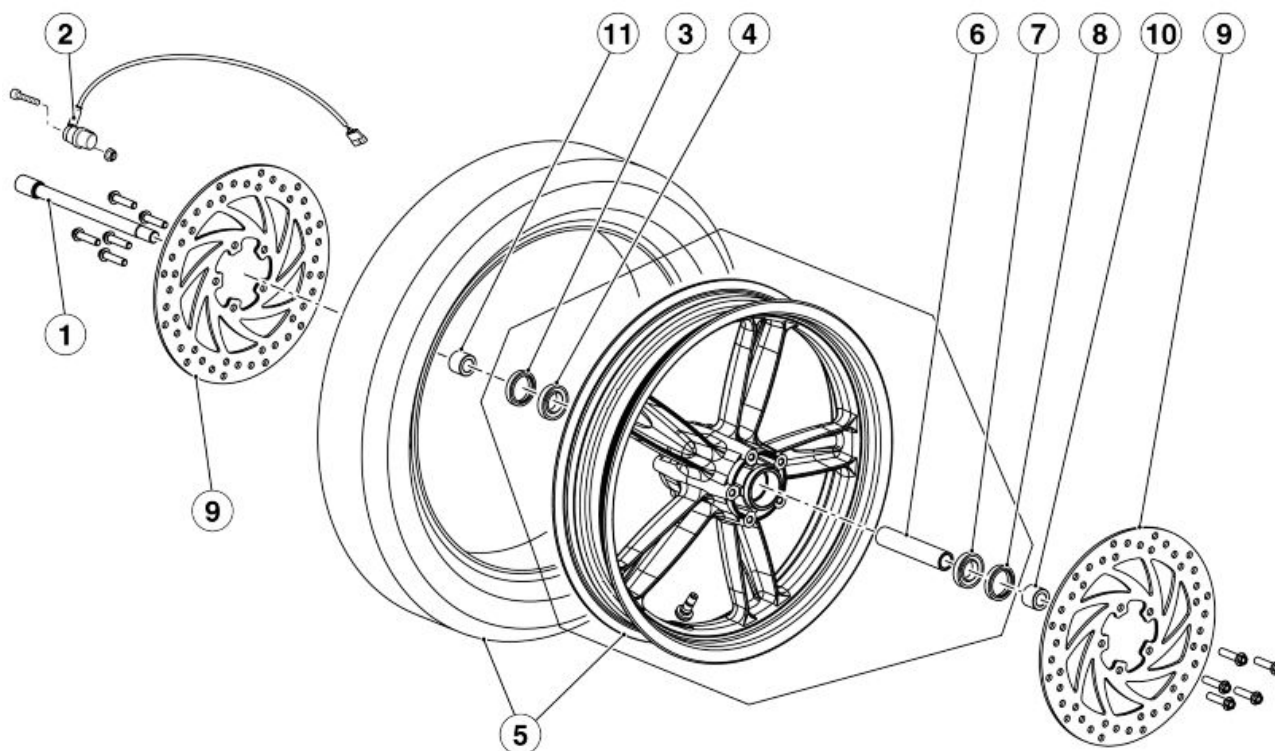

Key:

- 1. Wheel bolt
- 2. Odometer sensor
- 3. Right oil seal
- 4. Right bearing
- 5. Wheel
- 6. Internal spacer
- 7. Left bearing
- 8. Left oil seal
- 9. Brake discs
- 10. Left spacer
- 11. Right spacer

NOTE

GREASE THE WHEEL BOLT «1»

- Working from both sides, undo and remove the two calliper fixing screws.
- Remove both callipers from the front brake discs .

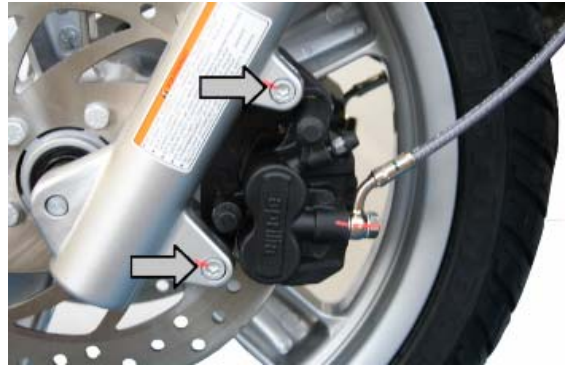

- Position the vehicle on the front service stand (OPT).
- Loosen the wheel bolt fixing screw on the right fork stem.



- Unscrew and remove the wheel bolt.



- Remove the wheel and collect the two external spacers.



Front fork

Removal

FORK REMOVAL

- Drain off the oil.
- Place the stem in a vice fitted with (aluminium) protection jaws.
- Undo and remove the lower screw «1» and collect the washer.



- Slide off the stem from the sleeve and collect the bushing.



- Slide off the pumping member «2» from the stem and collect the spring «3».

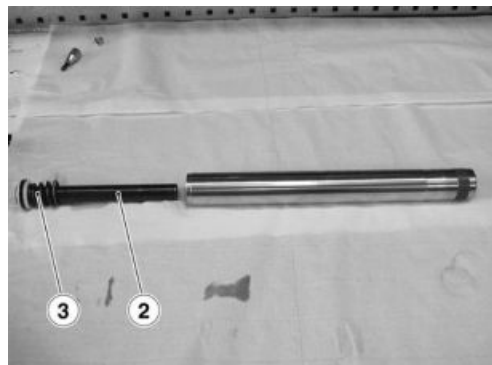

- Slide off the dust guard «4» from the sleeve.



- Slide off the snap ring «5» from the sleeve.



- Slide off the oil seal «6» from the sleeve.

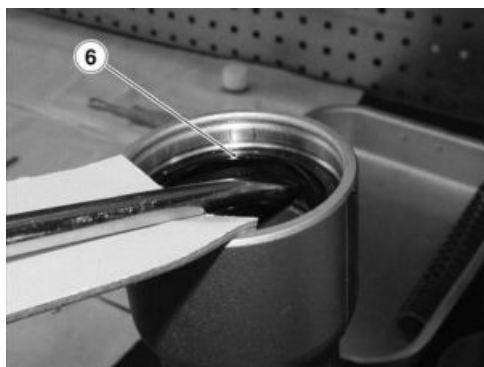

- Slide off the washer 7» from the sleeve.

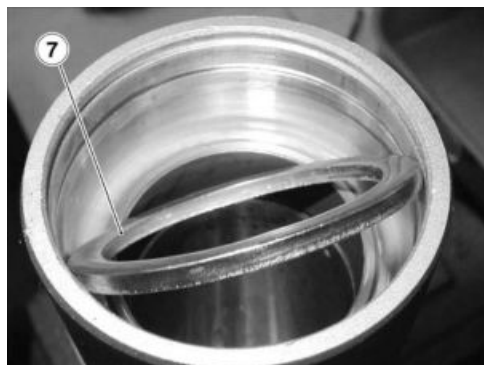

- Slide off the bushing 8» from the sleeve.



Oil emptying

NOTE

BEFORE CARRYING OUT THE FOLLOWING OPERATIONS GET A CONTAINER WITH SUITABLE CAPACITY TO COLLECT THE OIL.

- Place the sleeve in a vice.

CAUTION

THE WHEEL HOLDER STEM SLEEVE UNIT CONTAINS OIL. DO NOT TURN IT OVER OR TILT IT TOO MUCH WHEN REMOVING IT.



- Lower the cap «1» until the Seeger ring «2» can be removed.
- Remove the Seeger ring «2».



- Remove the cap «1» together with the O-ring.



- Remove the spring «3» and wait some minutes so that the oil deposited on it drips off.



- Drain off the oil into the collecting container by pumping it out with the stem.



- Hold the front part of the vehicle with a belt and a hoist.
- Remove the front wheel.
- Undo and remove screw for the front brake hose guide.

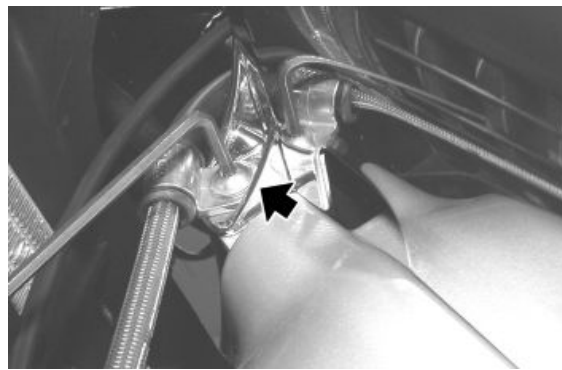

- Undo and remove the internal screw of the stem protection.



- Remove the stem protection.



- Unscrew and remove the screw fixing the speed sensor and collect the nut.



- Loosen the two screws fixing the fork stem.

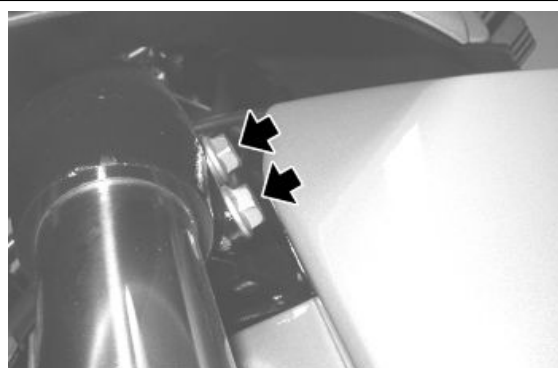

- Remove the upper retainer «2».
- Remove the wheel holder stem «3» by pulling it from the below.



Overhaul

Wheel holder stem

- Check the sliding surface for scorings and/or scratches. These scorings can be eliminated by rubbing them with wet sandpaper (grain 1).
- If the scorings are deep, replace the stem.
- Use a dial gauge to check that the stem bending is below the limit value.
- If over the value, replace the stem.

CAUTION



A BENT STEM SHOULD NEVER BE STRAIGHTENED BECAUSE ITS STRUCTURE WOULD BE WEAKENED AND USING THE VEHICLE MAY BECOME DANGEROUS.

Characteristic

Bending limit:

0.2 mm

Sleeve

- Check that there are no damages and/or cracks; otherwise, replace it.
- If there are signs of excessive wear or damage, replace the affected component.

Replace the following components with new ones:

- O-ring gasket on the cap «1»;
- oil seal «2»;
- dust guard «3».

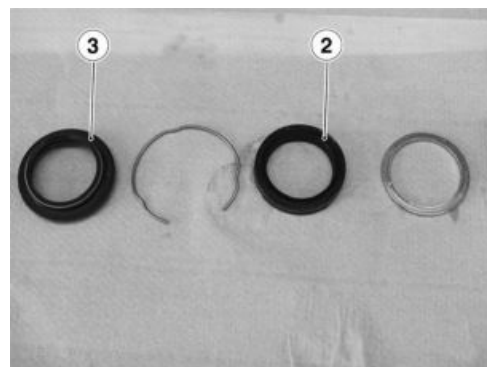
**Refitting**

- Place the sleeve in the vice fitted with (aluminium) protection jaws.
- Fit the spacer «1».

CAUTION

BE EXTREMELY CAREFUL SO THAT NO FOREIGN BODIES GET INTO THE SLEEVE OR THE WHEEL HOLDER STEM.

NOTE

SPREAD A THIN LAYER OF FORK OIL ON GASKETS AND BUSHINGS BEFORE REFITTING THEM.

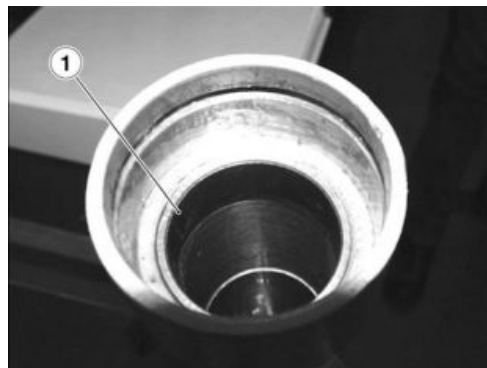

- Insert the washer.



- Insert the oil seal.



- Fit the snap ring.



- Fit the dust guard.



- Insert the pumping member and the spring in the stem.

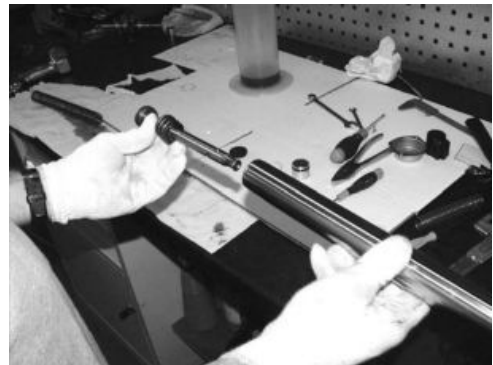

- Insert the stem together with the bushing «2» in the sleeve.

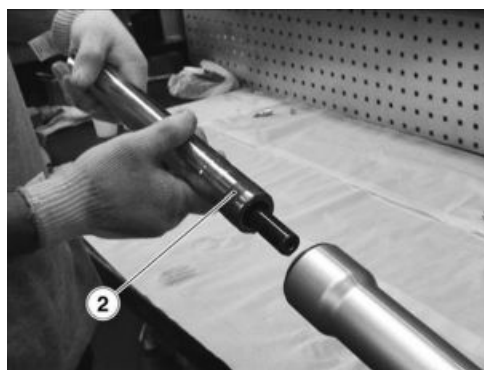

- Tighten the lower screw «3» together with its washer.
- Fill with oil.



OIL FILLING

- Place the wheel holder stem sleeve unit in a vice fitted with (aluminium) protection jaws.



- Pour fork oil into the wheel holder stem sleeve unit.

CAUTION

NEVER REUSE OIL.

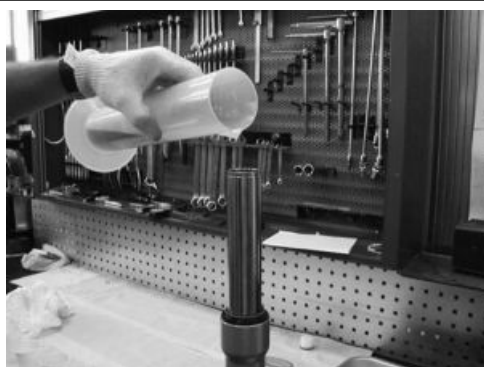

- Fit the spring.



- Fit the cap «1» together with the O-ring.



- Lower the cap «1» until the Seeger ring «2» can be inserted.
- Fit the Seeger ring «2».



Rear

Removing the rear wheel

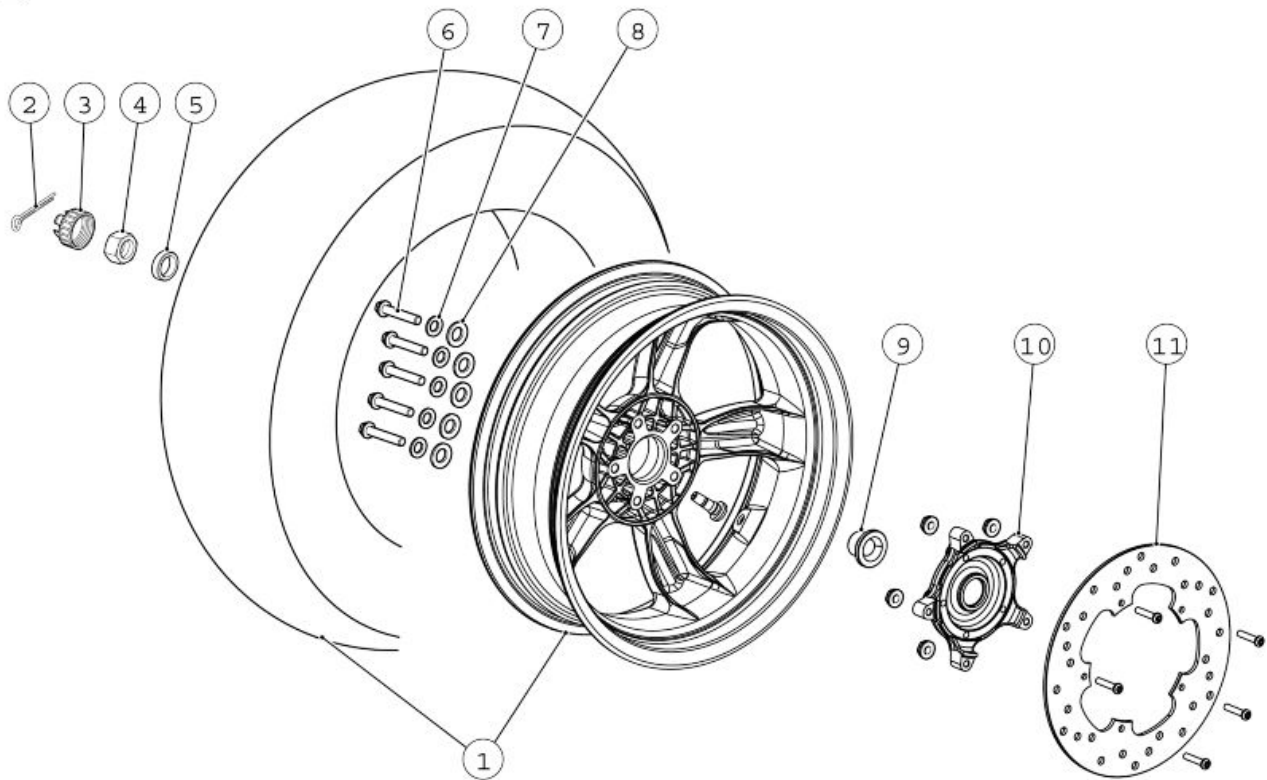

Key:

- 1. Complete wheel
- 2. Split pin
- 3. Cap
- 4. Nut
- 5. External spacer
- 6. Screw
- 7. Washer
- 8. Washer
- 9. Internal spacer
- 10. Wheel hub
- 11. Brake disc

- Working on the right side of the vehicle, undo and remove the two side screws fixing the rear mudguard; collect the two shim washers.



- Loosen the clamp of the exhaust manifold.



- Undo and remove the screw fixing the exhaust end sealing clamp.
- Push in the exhaust and remove the upper pin fixing the sealing clamp.



- Undo and remove the exhaust end fixing screw.
- Remove the exhaust end.



- Remove the safety split pin.

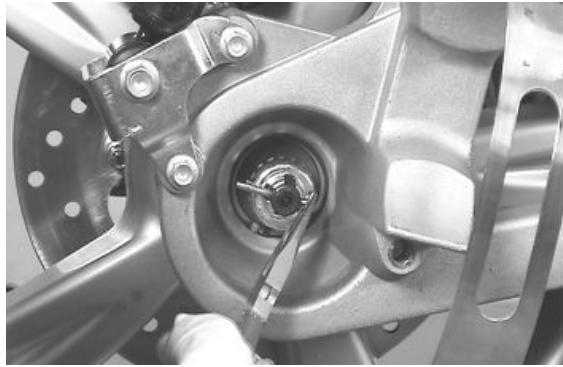

- Remove the cap.

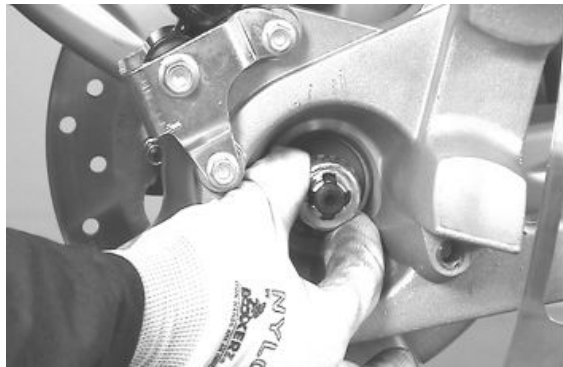

- With the help of a second operator, operate the rear brake; unscrew and remove the rear nut fixing the muffler supporting bracket.



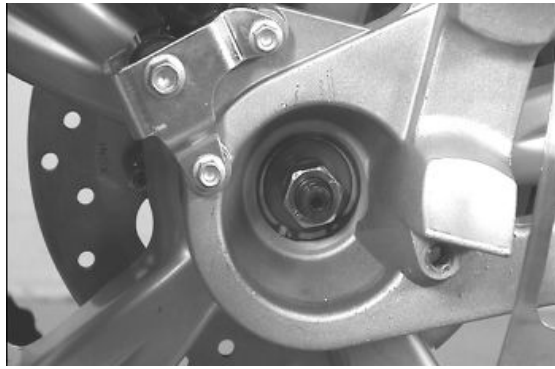

- Unscrew and remove the two front nuts fixing the muffler supporting plate.



- Remove the muffler supporting plate.



- Remove the spacer.
- Undo and remove the five screws fixing the wheel.
- Remove the wheel.

NOTE

PLACE AN ADEQUATE SUPPORT AT THE LOWER PART OF THE MOTOR VEHICLE.



INDEX OF TOPICS

BRAKING SYSTEM

BRAK SYS

Braking system diagram

NOTE

THIS VEHICLE IS FITTED WITH A BRAKING SYSTEM COMPRISING:

- TWO BRAKE DISCS ON THE FRONT WHEEL;
- ONE BRAKE DISC ON THE REAR WHEEL;
- A RETARDING VALVE LOCATED UNDER THE HEADLAMP.

Operating the right (front) brake lever exerts pressure on the front right brake calliper.

Operating the left (rear) brake lever, through the distribution valve, exerts pressure on the front left and rear brake callipers.

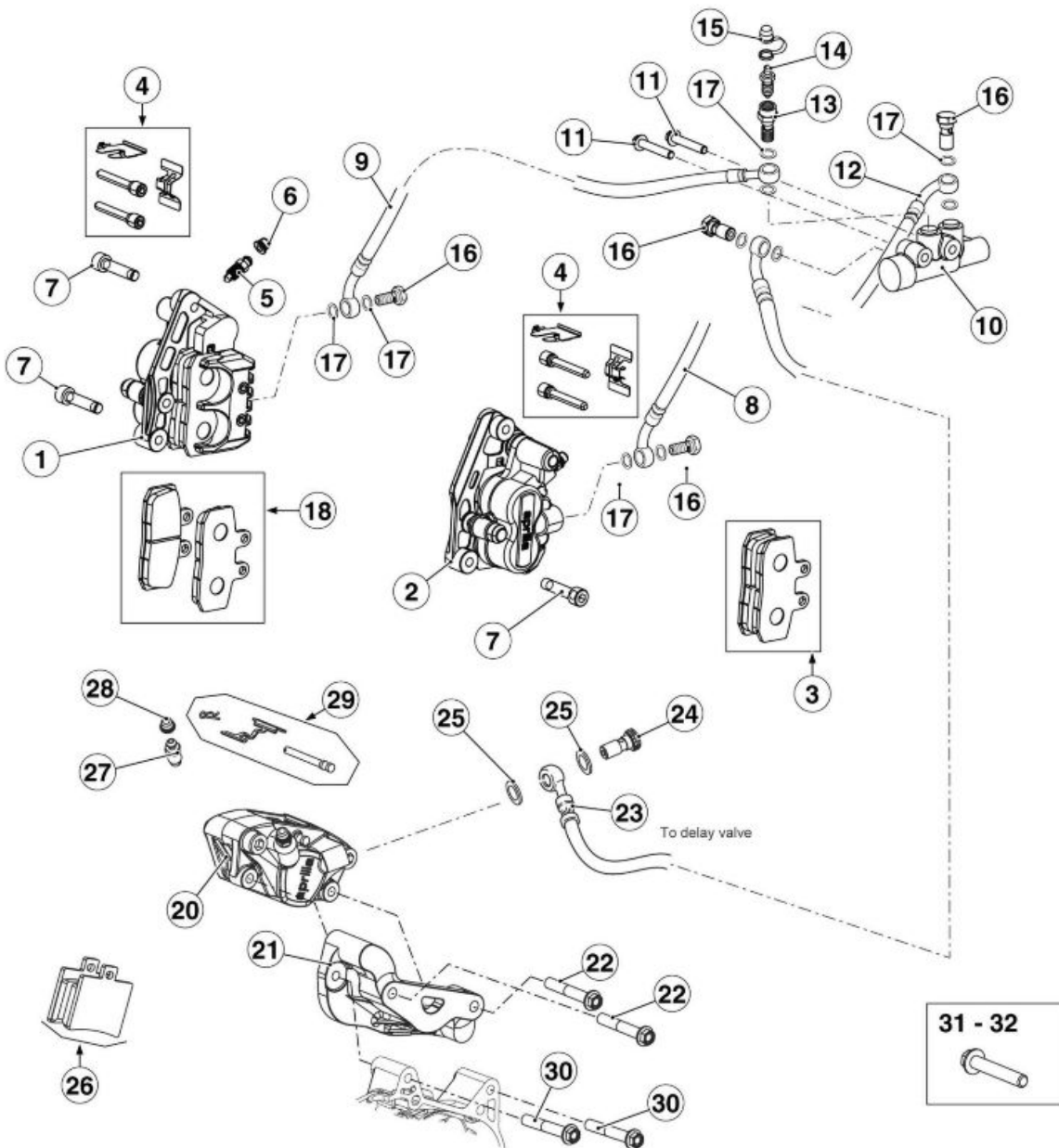

Key:

1. Front right brake calliper
2. Front left brake calliper

3. Pads - torques
4. Pins + spring set
5. Bleed pipe
6. Bleed pipe cap
7. M8x35 TCEI screw
8. Front brake pipe
9. Front calliper distribution pipe
10. Retarding valve
11. M6X20 TE flanged screw
12. Brake pump - distribution pipe
13. Capstan screw
14. Bleed pipe
15. Bleed pipe cap
16. Oil pipe screw
17. 10x14x1.6 Washer
18. Pads - torques
19. Calliper service kit
20. Rear brake calliper
21. Rear calliper support
22. M8X40 TE flanged screw
23. Rear calliper distribution pipe
24. Oil pipe screw
25. 10x14x1.6 Washer
26. Pads - torques
27. Bleed pipe
28. Bleed pipe cap
29. Pins + spring set
30. M8X50 TE flanged screw
31. M6X16 TE flanged screw
32. M6X25 TE flanged screw

Front brake calliper

Removal

CAUTION

THE OPERATIONS REFER TO ONLY ONE BRAKE CALLIPER, BUT APPLY TO BOTH CALLIPERS.

- Undo the two screws indicated and remove the brake calliper.

NOTE

SHOULD IT BE NECESSARY TO REPLACE THE CALLIPER, FIRST LOOSEN THE FITTING CONNECTING THE PIPE TO THE BRAKE CALLIPER.



Refitting

- To fit, follow the removal steps but in reverse order, and tighten the locking screws to the prescribed torque using the recommended product.

Recommended products

Loctite 243 Medium strength threadlock

-

Locking torques (N*m)

Front brake calliper fixing screw 25

- If the calliper is disconnected from the brake pipe:

CAUTION



ALWAYS USE NEW SEAL GASKETS FOR THE BRAKE PIPE UNION.

CAUTION



ONCE REFITTING IS FINISHED, BLEED THE SYSTEM.

Locking torques (N*m)

Brake fluid pipe-calliper fitting 20 ÷ 25

Front brake pads

Removal

CAUTION

THE OPERATIONS REFER TO ONLY ONE BRAKE CALLIPER, BUT APPLY TO BOTH CALLIPERS.

- Remove the brake calliper.
- Undo the two screws indicated.



- Push the floating pad of the calliper.



- Remove the brake pads.

CAUTION



AFTER REMOVING THE PADS, DO NOT OPERATE THE BRAKE CONTROL LEVER; OTHERWISE, THE CALLIPER PLUNGER COULD GO OUT OF ITS SEAT RESULTING IN BRAKE FLUID LEAKAGE.



- Check the thickness of the friction material. Replace if the thickness is below the minimum value.

Characteristic

Minimum thickness of the friction material

1.5

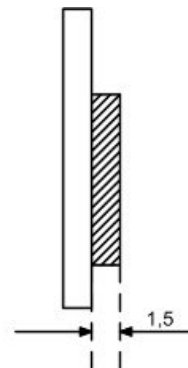

- In case of uneven wear, replace the pads when there is a thickness difference of 0.5 mm in the friction material.

CAUTION

ALWAYS REPLACE BOTH PADS AND MAKE SURE THEY ARE CORRECTLY POSITIONED INSIDE THE CALLIPER.

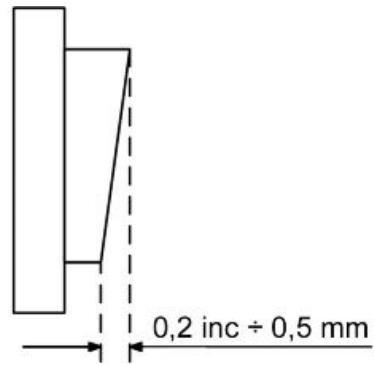

Refitting

- To fit, follow the removal steps but in reverse order, and tighten the locking screws to the prescribed torque using the recommended product.

Recommended products

Loctite 243 Medium strength threadlock

-

Locking torques (N*m)

Brake pad fixing screws XX Nm

Rear brake pads

Removal

- Remove the rear wheel.
- Remove the cotter pin.



- Slide off the pin.



- Remove the spring.



- Slide off the brake pads.

CAUTION



AFTER REMOVING THE PADS, DO NOT OPERATE THE BRAKE CONTROL LEVER; OTHERWISE, THE CALLIPER PLUNGER COULD GO OUT OF ITS SEAT RESULTING IN BRAKE FLUID LEAKAGE.

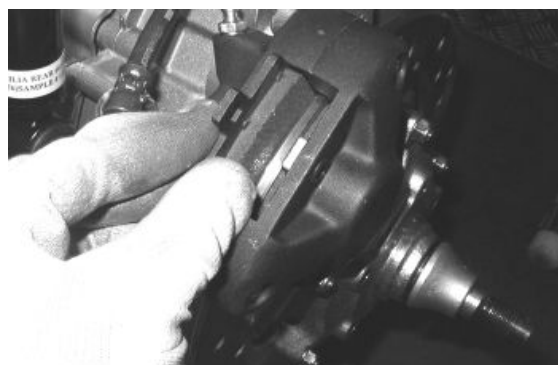

CAUTION



ALWAYS REPLACE BOTH PADS AND MAKE SURE THEY ARE CORRECTLY POSITIONED INSIDE THE CALLIPER.

- Check the thickness of the friction material. Replace if the thickness is below the minimum value.

Characteristic

Minimum thickness of the friction material

1.5

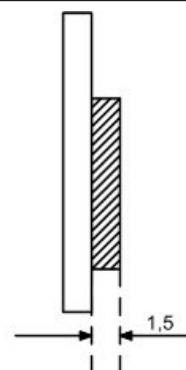

- In case of uneven wear, replace the pads when there is a thickness difference of 0.5 mm in the friction material.

CAUTION

ALWAYS REPLACE BOTH PADS AND MAKE SURE THEY ARE CORRECTLY POSITIONED INSIDE THE CALLIPER.

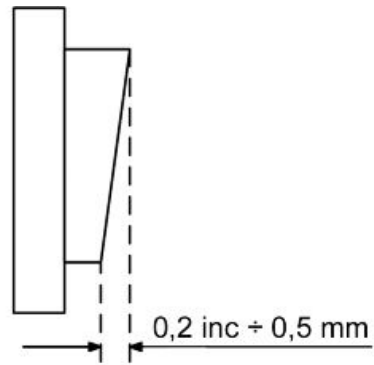
**Refitting**

- Fit two new brake pads.

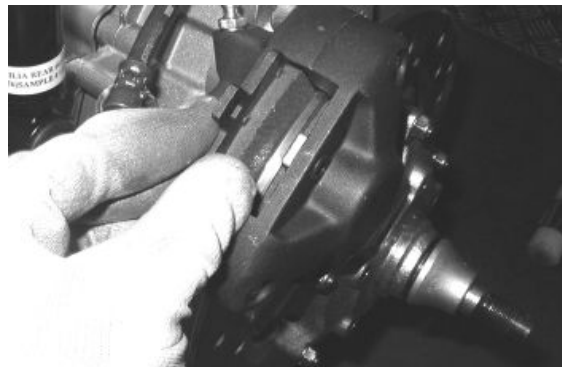

- Fit the spring.

CAUTION

THE ARROW STAMPED ON THE SPRING MUST ALWAYS BE TURNED IN THE RIDING DIRECTION.

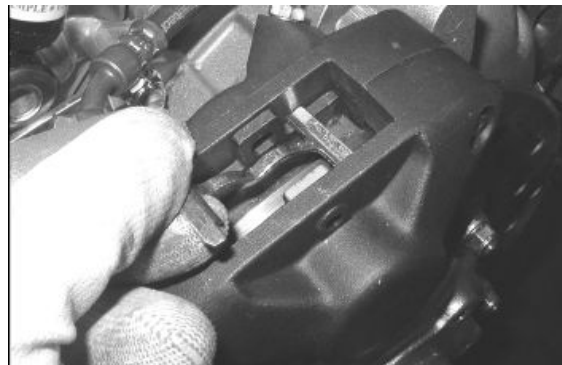

- Refit the pin.



- Insert the cotter pin.
- Fit the rear wheel.



Fill - Bleeding the braking system

Rear - combined

Distribution valve

- Remove the front central cover.
- Remove the rubber protection cover «2» from the bleed valve «3».
- Insert a transparent plastic pipe on the bleed valve «3» of the distribution valve and insert the other end of the pipe in a collecting container.
- Quickly operate and release the rear brake lever several times, keeping it completely operated afterwards.
- Loosen the bleed valve 1/4 of a turn so that the brake fluid flows into the container. This will release tension on the brake lever and will make it go to the end of stroke.
- Repeat the operation until the fluid draining into the container is completely free of air bubbles.

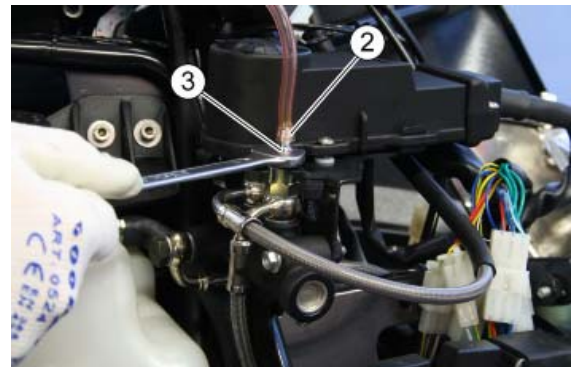

NOTE

WHILE PURGING THE HYDRAULIC SYSTEM, FILL THE RESERVOIR WITH THE NECESSARY QUANTITY OF BRAKE FLUID. CHECK THAT, DURING THE OPERATION, THERE IS ALWAYS BRAKE FLUID IN THE RESERVOIR.

- Close the bleed valve and remove the pipe.

- Top-up the reservoir until the correct brake fluid level is obtained.
- Refit the rubber protection cover.

Front brake

- Remove the rubber protection cover from the bleed valve «4».
- Insert a transparent plastic pipe on the bleed valve «4» of the front brake caliper and insert the other end of the pipe in a collecting container.
- Quickly operate and release the front brake lever several times, keeping it completely operated afterwards.
- Loosen the bleed valve 1/4 of a turn so that the brake fluid flows into the container. This will release tension on the brake lever and will make it go to the end of stroke.
- Repeat the operation until the fluid draining into the container is completely free of air bubbles.



NOTE

WHILE PURGING THE HYDRAULIC SYSTEM, FILL THE RESERVOIR WITH THE NECESSARY QUANTITY OF BRAKE FLUID. CHECK THAT, DURING THE OPERATION, THERE IS ALWAYS BRAKE FLUID IN THE RESERVOIR.

- Close the bleed valve and remove the pipe.
- Top-up the reservoir until the correct brake fluid level is obtained.
- Refit the rubber protection cover.

REAR BRAKE

- Remove the rubber protection cover from the bleed valve «5».
- Insert a transparent plastic pipe on the bleed valve «5» of the rear brake caliper and insert the other end of the pipe in a collecting container.
- Quickly operate and release the rear brake lever several times, keeping it completely operated afterwards.



- Loosen the bleed valve 1/4 of a turn so that the brake fluid flows into the container. This will release tension on the brake lever and will make it go to the end of stroke.
- Repeat the operation until the fluid draining into the container is completely free of air bubbles.

NOTE

WHILE PURGING THE HYDRAULIC SYSTEM, FILL THE RESERVOIR WITH THE NECESSARY QUANTITY OF BRAKE FLUID. CHECK THAT, DURING THE OPERATION, THERE IS ALWAYS BRAKE FLUID IN THE RESERVOIR.

- Close the bleed valve and remove the pipe.
- Top-up the reservoir until the correct brake fluid level is obtained.
- Refit the rubber protection cover.

Front

- Remove the rubber protection cover of the bleed valve «1».
- Insert a transparent plastic pipe in the bleed valve «1» of the front brake calliper and insert the other end of this pipe into a container to collect the fluid.
- Quickly press and release the brake lever of the specific brake calliper several times, keeping it completely operated afterwards.
- Loosen the bleed valve «1» ¼ of a turn so that the brake fluid flows into the container. This will release tension on the brake lever and will make it go to the end of stroke.
- Repeat the operation until the fluid draining into the container is completely free of air bubbles.

**NOTE**

WHILE PURGING THE HYDRAULIC SYSTEM, FILL THE RESERVOIR WITH THE NECESSARY QUANTITY OF BRAKE FLUID. CHECK THAT, DURING THE OPERATION, THERE IS ALWAYS BRAKE FLUID IN THE RESERVOIR.

- Close the bleed valve «1» and remove the pipe.
- Top up restoring the correct front brake fluid level in the reservoir.
- Refit the rubber protection cover.

Rear brake pump - combined

Removal

- Remove the legshield.
- Undo and remove the three screws fixing the antitheft control unit.
- Detach the antitheft control unit but keep it connected to the wiring.

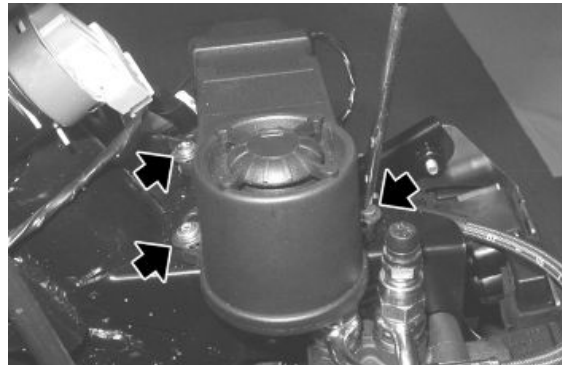

- Drain the braking system completely.
- Undo and remove the two screws «1» and the bleed valve «2».
- Protect the three brake pipes to prevent brake fluid spilling.
- Undo and remove the two screws «3» fixing the distribution mechanism.
- Remove the distribution mechanism.

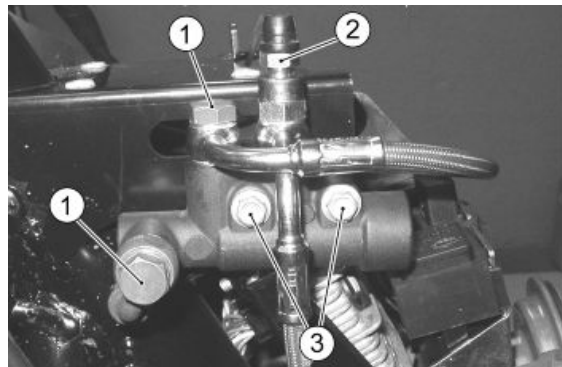

NOTE

MARK THE BRAKE PIPES TO PREVENT INCORRECT REFITTING.

NOTE

UPON REFITTING PURGE THE AIR OF THE BRAKING SYSTEM.

NOTE

ALWAYS USE NEW SEAL GASKETS FOR THE BRAKE PIPE UNION.

INDEX OF TOPICS

COOLING SYSTEM

COOL SYS

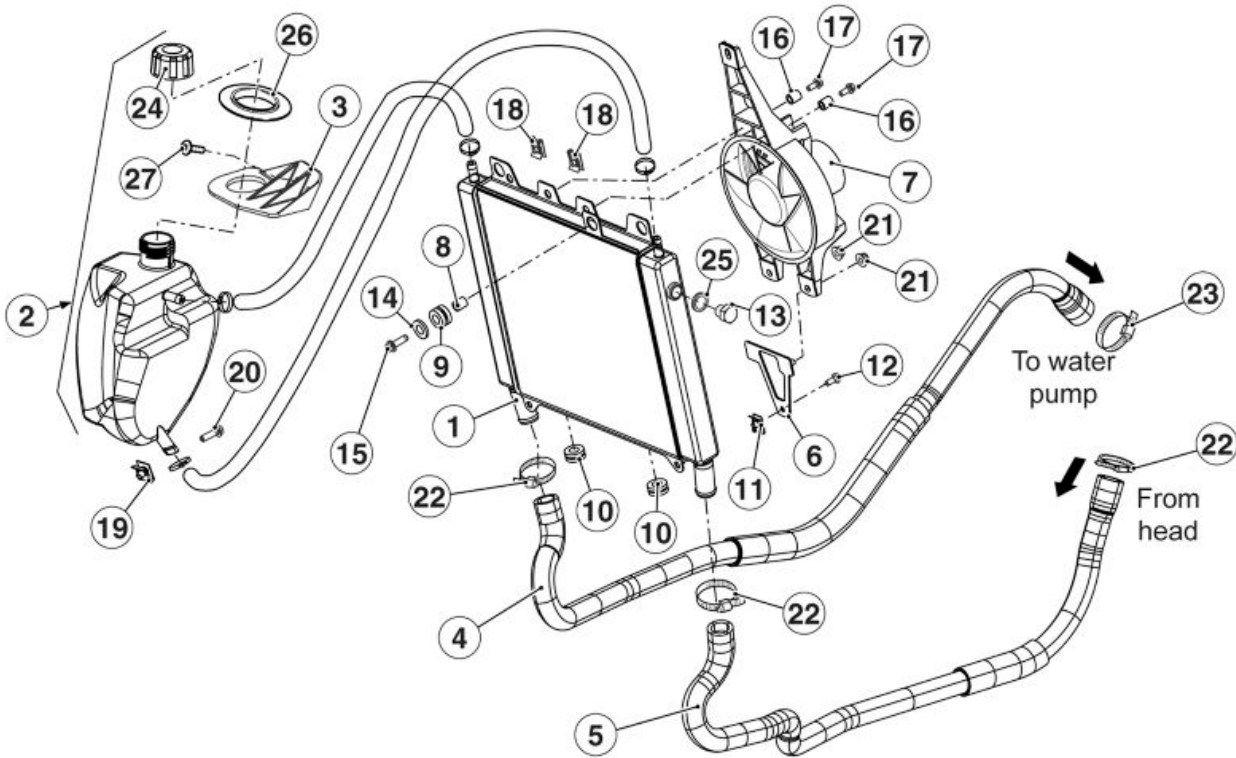
Circuit diagram
**KEY:**

1. Radiator
2. Expansion tank
3. Expansion tank support
4. Head-radiator fitting pipe
5. Pump-radiator fitting pipe
6. Electric fan support
7. Electric fan
8. Spacer bushing
9. Upper fixing rubber ring
10. Lower fixing rubber ring
11. M5 Clip
12. M5X12 TE flanged screw
13. Threaded cap
14. 6.6x18x1.6 Washer
15. M6X20 TE flanged screw
16. Bushing

17. M5X12 TE flanged screw
18. M5 Clip
19. M6 Clip
20. Flanged self-locking M6 nut
21. Clamp, D.16 24X8
22. Clamp, D.16 24X8
23. Pipe clamp
24. Expansion tank cap
25. Aluminium washer, 14X22X1
26. Filler rubber ring
27. M6X16 Flanged TBEI screw

System sealing check

- Check the proper sealing of the circuit when it is subject to pressure and at the correct temperature.
- For a more accurate check, wait until the system has cooled down since small leaks may not be visible due to evaporation.
- The water pump is provided with a drainage hole in case of leaks from the cooling system mechanical seal, or from the shaft sealing oil guard.
- If coolant or oil leaks are detected, inspect the pump (see the «Engine/Water pump» chapter).



NOTE

DO NOT USE GREASES OR OILS WHILE REPAIRING THE COOLING SYSTEM. FAILURE TO OBSERVE THIS RULE CAN IRRETRIEVABLY DEFORM THE SEALING GASKETS.

Coolant replacement

CAUTION



THE RECOMMENDED COOLANT MUST BE USED FOR TOP-UPS TO AVOID DAMAGING THE ENGINE.

System top-up instructions

- Fill the system up to a level ranging between the MIX and MAX levels indicated in the expansion tank filler.
- Do not close the expansion tank with the cap.

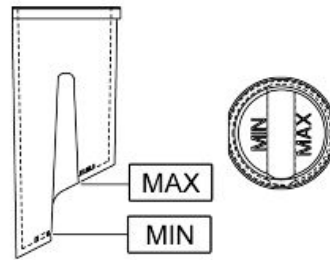

Recommended products

AGIP PERMANENT SPEZIAL Coolant

Biodegradable coolant, ready for use, with "long life" technology and characteristics (pink). Freezing protection up to -40°C . According to CUNA 956-16 standard.

- Use a transparent flexible hose to connect the bleed pipe union with the expansion tank filler.
- Loosen the bleed pipe and start the engine.



- Keep it open until the air has been fully vented.
- Screw the bleed screw again.
- Stop the engine.
- Restore the level into the expansion tank and tighten the cap.
- Start the engine and leave it running to warm up until the electric fan triggering temperature is reached.
- Shut off the engine.
- Restore the level with cold engine.

CAUTION

THE ELECTRIC FAN IS CONTROLLED BY THE TEMPERATURE MEASURED AT THE HEAD. THAT THE ELECTRIC FAN STARTS DOES NOT MEAN THAT THE PURGE HAS BEEN COMPLETED.

PURGING IS COMPLETE WHEN THE EXPANSION TANK TEMPERATURE RISES.

Water pump - overhaul

In case of noise or fluid leaks from the water pump drainage hole, inspect the pump as described in the «Engine/Water pump» Chapter.

Proceed to carry out a few preliminary operations as described below:

- Place the vehicle on its centre stand and on level ground.
- Remove the tail section as described in the «Bodywork» Chapter.
- Empty the cooling system by removing the sleeves located on the water pump cover and the filler cap located on the expansion tank.



CAUTION

THIS OPERATION MUST BE CARRIED OUT WHEN THE ENGINE IS COLD.

- Remove the water pump cover shown in the figure by loosening the six fixing screws.
- Follow the instructions described in the «Engine/Water pump» Chapter to check the pump.
- Once the fault has been fixed and all components have been replaced, fill and drain the system again.



NOTE

TO CHANGE COOLANT AND PURGE THE SYSTEM, SEE THE «COOLING» CHAPTER.

Water pump cover removal:

- Check that the water pump cover is not dented or distorted.
- Check that the sealing O-Ring is in good conditions.
- Otherwise, replace the component.



- Place a new O-ring with caution so that it does not come into contact with any grease or oil.

FAILURE TO OBSERVE THIS RULE CAN IRRETRIEVABLY DEFORM THE O-RING.

- Refit the water pump cover and tighten the six fixing screws to the prescribed torque.

Locking torques (N*m)**Water pump cover screws 3 ÷ 4****Water pump ceramic seal**

Our fluid-cooled engines are fitted with water pumps made with this type of ceramic seal. This element ensures coolant tightness at the pump shaft. The sealing is carried out by two ceramic surfaces, one fixed and one moving, that are kept into contact with the pump shaft by the thrust of a coaxial spring. Correct functioning is ensured by an accurate machining of the ceramic parts and adequate cleaning of the components at the assembly stage, in any case the ceramic seals are mounted at an initial run-in stage. During this first period of use (1000 ± 1500 km) there may be some little seeping through the drainage holes that leave traces on the aluminium housing. This fact is particularly evident where the drainage is more visible. If this occurs, clean the housing and then check tightness again for trips over 1500 km. If seeping persists or in case there are true leaks, replace the ceramic seal. To carry out these operations, follow the procedures and use the appropriate tools indicated in the relevant service station manuals.

diagnosis

Excessive system pressure

1 - Check the expansion tank cap efficiency.

NOTE

THE CAP IS PROVIDED WITH A PRESSURE RELIEF VALVE CALIBRATED AT 0.9 BAR.

There is also a valve that lets air in during the cooling stage.

YES - go to point 2 NO go to point 3

2 - Check the head gasket seal (see the «Thermal group and Timing system» chapter)

3. Replace the cap.

Cooling fluid consumption

1 - Check the system external seals as described above.

YES - go to point 2 NO go to point 3

2 - Check the head gasket seal (see the «Thermal group and Timing system» chapter)

- If water leaks are detected in the engine oil, inspect the buffer on the head cooling circuit.

3 - Fix any damaged seals.

Oil in the fluid

1 - There is oil in the coolant.

YES go to point 2

2 - Check the head gasket seal (see the «Thermal group and Timing system» chapter)

INDEX OF TOPICS

CHASSIS

CHAS

Seat

It is necessary to lift the saddle before removing it.

There are two ways to do so:

- use the supplied remote control, press the key «1» and the saddle will open automatically.



- Insert the key in the key lock and press down. The glove-box opens automatically. Pull the left lever to open the saddle manually.



- Lift the saddle.
- Remove the central inspection cover.
- Remove the cotter pin and collect the washer.



- Slide off the pin.
 - Remove the saddle.
-

SADDLE OPENING SYSTEM REMOVAL

- Remove the central inspection cover (SEE TAIL SECTION).
- Remove the control cable.



- Release the control cable and the saddle unlocking cable.

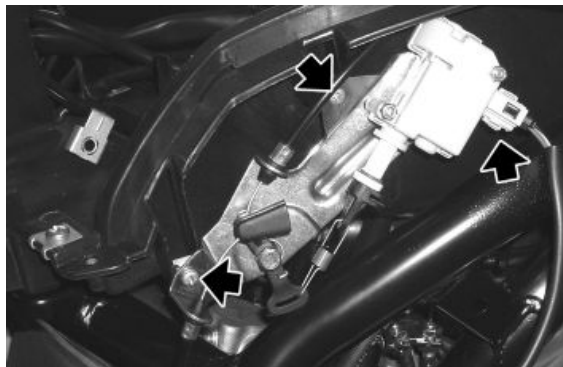

- Remove the connector.
- Undo and remove the two fixing screws.
- Remove the saddle opening system.

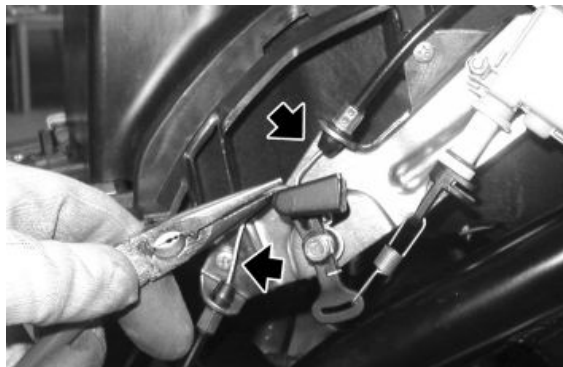

Instrument panel

- Remove the front headlight assembly.
- Operating from both sides undo and remove the two front handlebar cover screws.



- Detach the handlebar protection.



- Undo and remove both upper screws fixing the instrument panel.



- Remove the front handlebar cover.



- Disconnect the instrument panel connector.



- Undo and remove the two lower screws fixing the rear handlebar cover.
- Remove the rear handlebar cover together with the instrument panel.

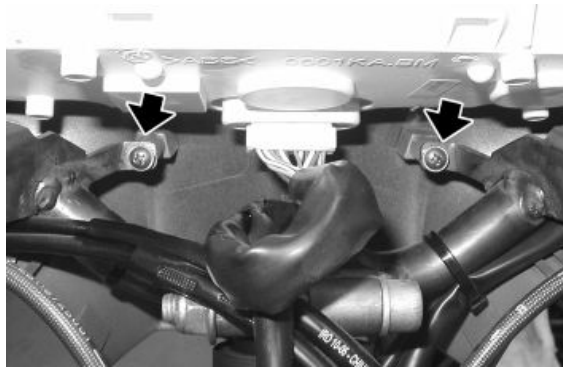

Headlight assy.

- Undo and remove the screw fixing the headlamp front cowl.



- Remove the headlamp front cowl.



- Slide off the upper cap from the tongues to remove it.

CAUTION

**PROCEED WITH CAUTION.
DO NOT DAMAGE THE TABS AND/OR THEIR
CORRESPONDING SLOTS.**



- Undo and remove both screws fixing the headlamp to the chassis.

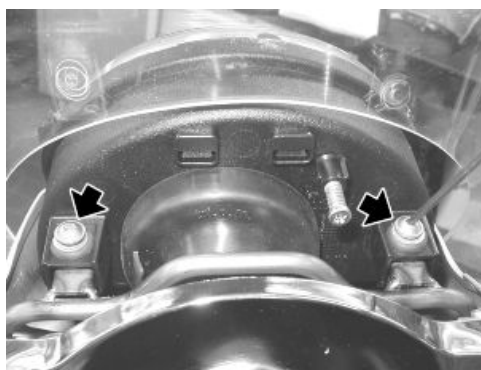

- Move the headlamp and disconnect the connector.
- Remove the headlamp; be careful not to damage it.

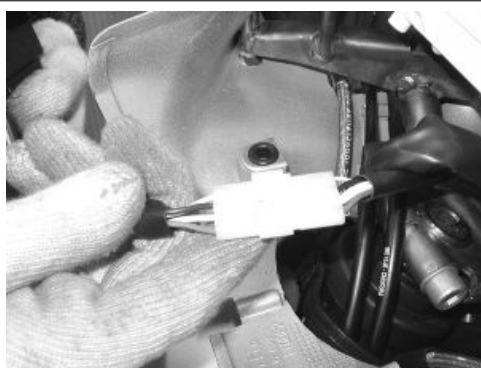

Legshield

- Rest the vehicle on its centre stand.
- Turn the handlebar completely to the right and remove the upper screw.

NOTE

Repeat the same procedure on the opposite side, turning the handlebar fully to the left.



- Turn the handlebar completely to the right and remove the lower screw.
- Slightly lift the legshield lower section and remove it by sliding it off from the tongues.

NOTE

Repeat the same procedure on the opposite side, turning the handlebar fully to the left.

CAUTION

**PROCEED WITH CAUTION.
DO NOT DAMAGE THE TABS AND/OR THEIR
CORRESPONDING SLOTS.**



Remove the legshield to access:

- the expansion tank;
- the turn indicator bulbs;
- the voltage regulator;
- the horn;
- the relay;
- the fall sensor;
- the antitheft control unit.



Knee-guard

- Remove the legshield.
- Remove the four screws «1» placed under the shield.



- Remove the four screws «2», two per side, inside the wheel housing.



- Remove the five screws «3» placed inside the glove-box.





Footrest

- Remove the tail section.
- Remove the central tunnel.
- Undo and remove the two lower screws.

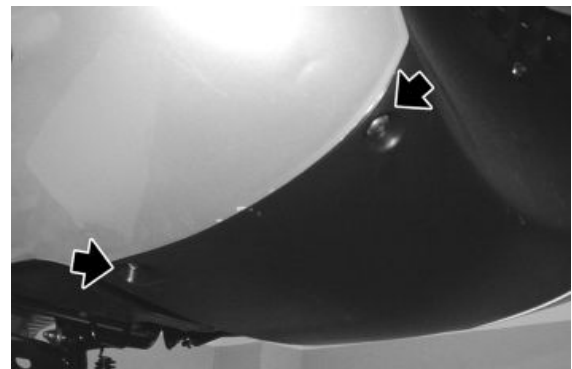

- Remove the plastic footrest.

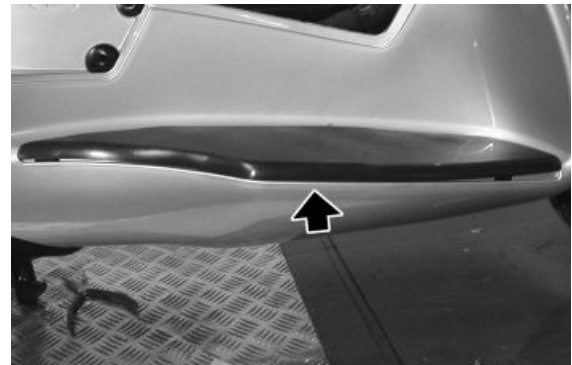

- Undo and remove the two upper screws.
- Remove the footrest.



Air filter

- Working on the left side of the vehicle, undo and remove the two side screws fixing the rear mudguard and collect the two washers.

NOTE

UPON REFITTING, PAY ATTENTION TO THE LENGTH OF THE FIXING SCREWS, THE REAR SCREW IS SHORTER.

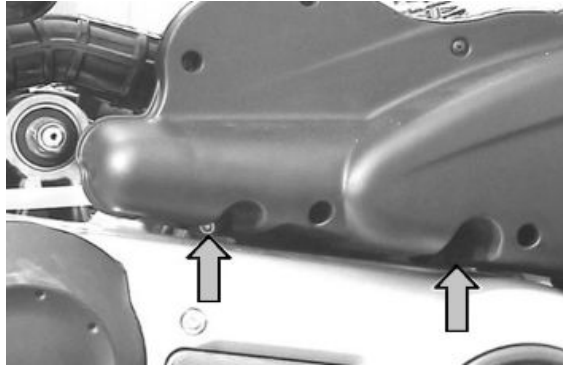

- Undo and remove the oil scavenge flange fixing screw.



- Slide the flange off its seat.



- Undo the air filter internal support screw.



- Loosen the intake manifold clamp.
- Remove the clamp indicated.



- Slide off the bleed pipe.



- Remove the filter housing.



Tail guard

- Rest the vehicle on its centre stand.
- Working on both sides, open the passenger footrest.
- Working on both sides, undo and remove the three screws fixing the footrest.
- Working on both sides, remove both footrests.

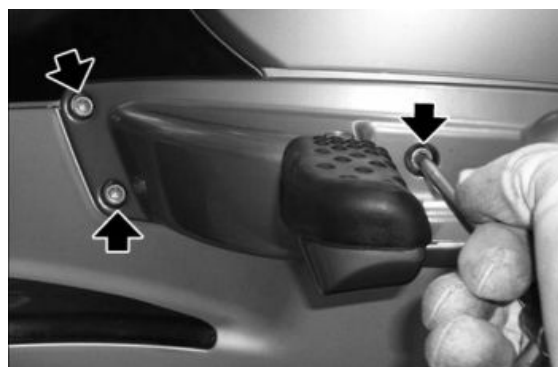

NOTE

UPON REFITTING, PAY ATTENTION THAT THE REAR SCREW IS LONGER THAN THE FRONT SCREWS.

- Lift the saddle.
- Undo and remove the two upper screws fixing the central inspection cover.

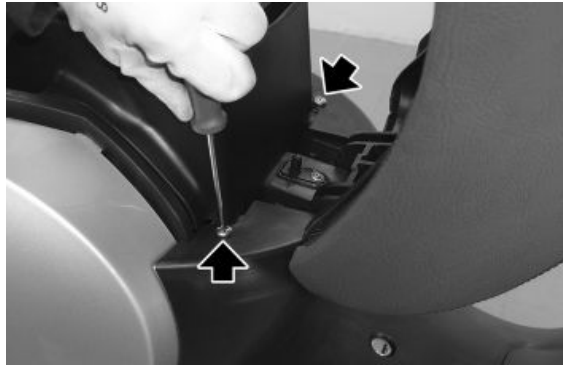

- Undo and remove the lower screw fixing the central inspection cover.

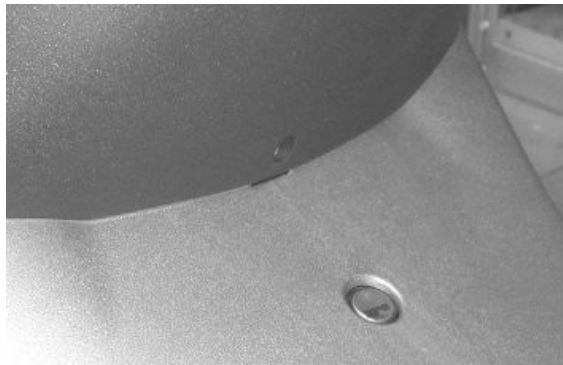

- Lower the saddle.
- Remove the central inspection cover.



- Undo and remove the two front screws fixing the tail section.



- Working on both sides, undo and remove the two side lower fixing screws.

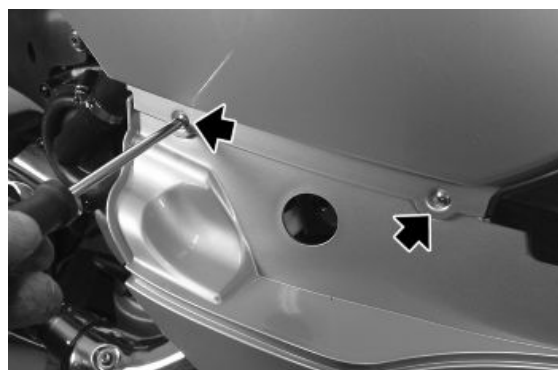

- Undo and remove the four screws fixing the passenger grab handle.

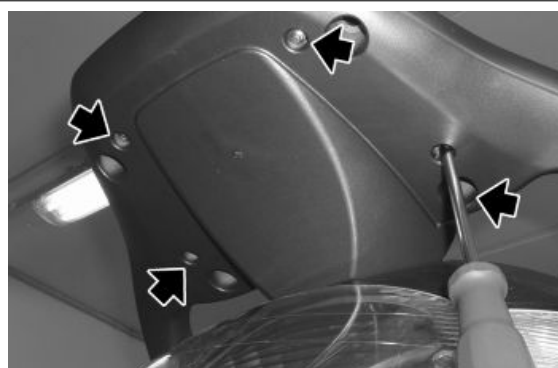

- Remove the cover.

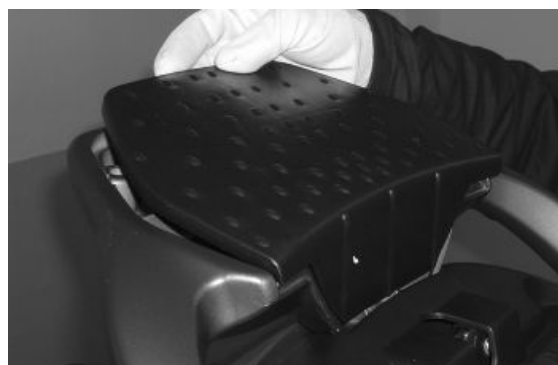

- Undo and remove the three screws fixing the passenger grab handle.

NOTE

UPON REFITTING, PAY ATTENTION THAT THE CENTRAL SCREW IS LONGER THAN THE SIDE SCREWS.



- Remove the rear light upper lock.



- Undo and remove the two rear screws fixing the tail section.

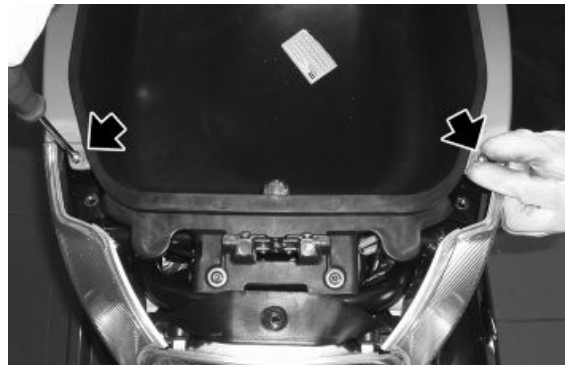

- Disconnect the three connectors.
- Remove the tail section together with the rear light.



- Once the tail section is removed, the fairings can also be removed by loosening the three screws indicated on both sides.



Helmet bay

- Lift the saddle.
- Undo and remove the two screws fixing the battery cover.
- Remove the battery protection cover.



-
- Remove the tail section.
 - Remove the saddle.
 - Disconnect the electrical connector.



-
- Disconnect the saddle opening - actuator control cable.



-
- Slide off the start-up relay.



- Slide off the cables from the helmet compartment.



- Undo and remove the fixing screw of the helmet compartment light switch.

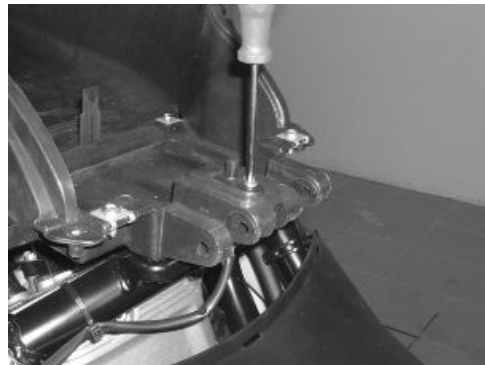

- Disconnect the two connectors of the helmet compartment light switch.



- Remove the helmet compartment light bulb.



- Undo and remove the two front screws.

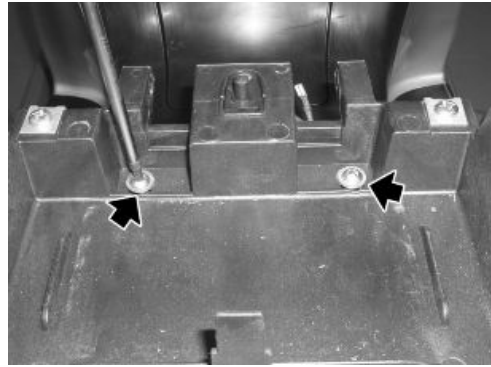

- Working on both sides, undo and remove the side screws.



- Undo and remove the two rear screws.

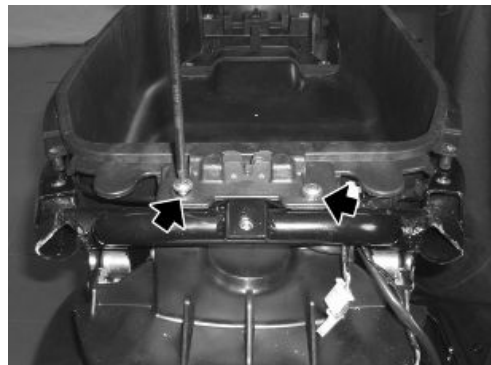

- Undo and remove the screws fixing the helmet compartment - license plate.

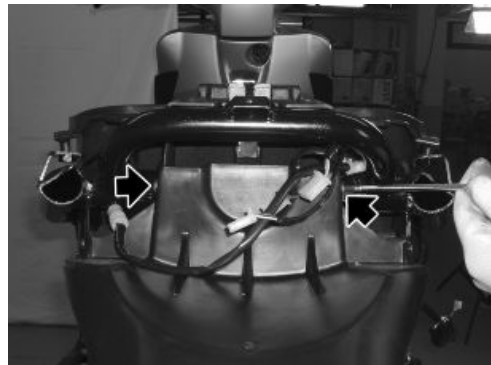

10. Rubber ring

11. M6 Clip

12. M6X20 TE flanged screw

13. Fuel pipe, D5.5x10

14. 6.6x18x1.6 Washer

Tank removal

- Remove the front central cover.
- Remove the tail section.
- Remove the footrest.
- Remove the stem covers.
- Remove the front mudguard by undoing the four internal fixing screws.
- Undo and remove the two spoiler front fixing screws.



- Disconnect the electric connection and the fuel delivery pipe.

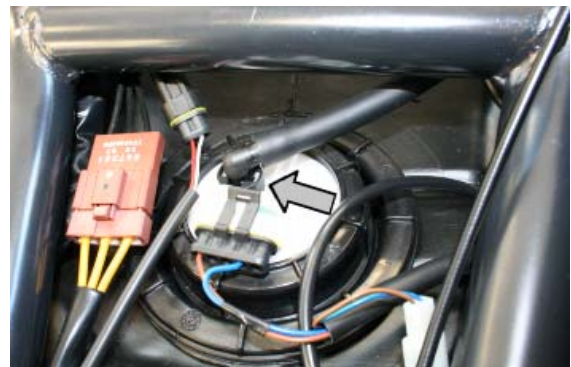

- Working on the left side, disconnect the electric connector and working on the right side, slide off the pipe.

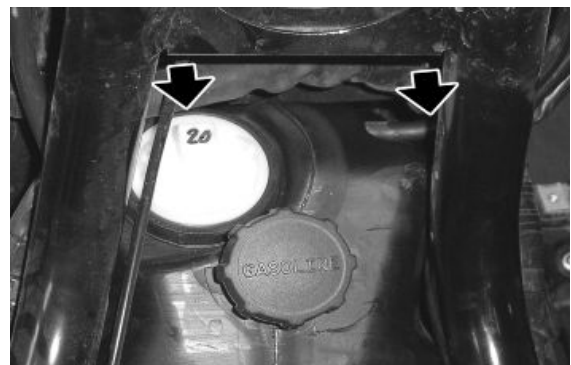

- Move the spoiler towards the mud-guard so as access the tank underneath and front parts.
- Working on both sides, undo and remove the screw of the rear lower supporting cross-member.
- Remove the cross-member.



- Working on both sides, undo and remove the two screws fixing the front lower support cross-member.
- Remove the cross-member.

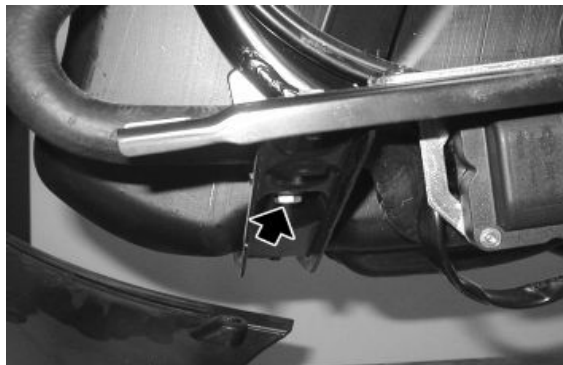

- Undo and remove the front screw fixing the fuel tank.



- Undo and remove the tank rear fixing screw.
- Detach the fuel tank from the chassis and remove it.



Expansion tank

- Drain off the cooling system.
- Remove the legshield.
- Detach the expansion tank from the breather pipe «3».
- Unscrew and remove the two upper screws «1» of the expansion tank.

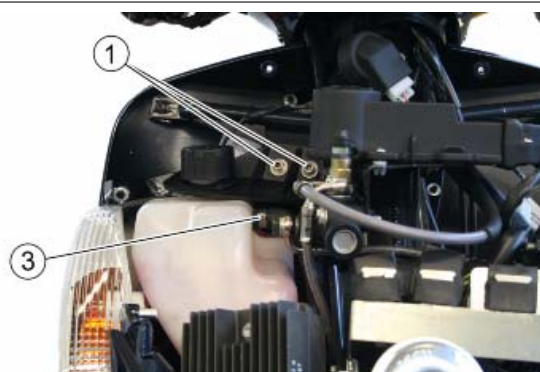

- Open the glove-box.
- Undo the lower screw «2» of the expansion tank through the glove-box hole.
- Lift the expansion tank and disconnect the lower pipe of the cooling system.
- Remove the expansion tank.

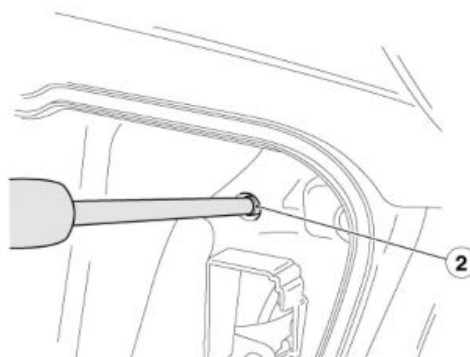

Front central cover

- Remove the passenger footrests by undoing the three screws indicated in the figure on each side.

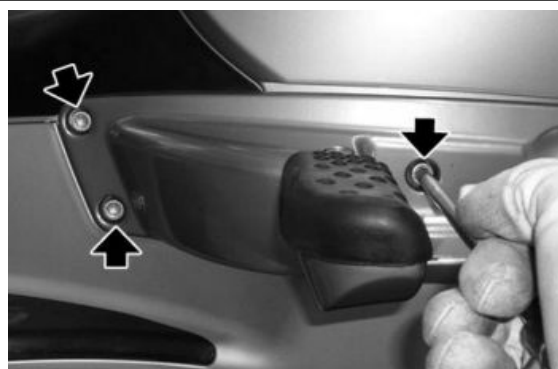

- Remove the screw «1» placed under each footrest.



- Remove the shield back plate.
- Remove the two screws «2».

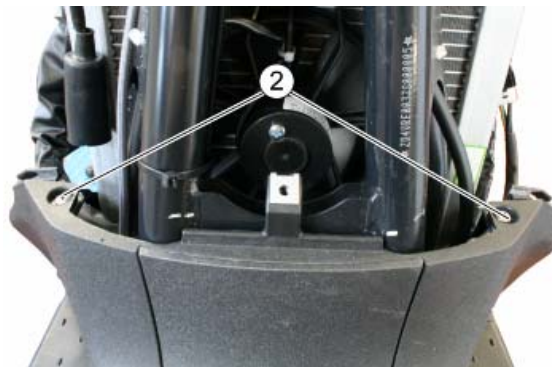

INDEX OF TOPICS

PRE-DELIVERY

PRE DE

Before handing over the vehicle, carry out the checks listed below.

WARNING

BE EXTREMELY CAUTIOUS WHEN HANDLING FUEL.

Aesthetic inspection

- Paintwork
 - Fitting of plastic parts
 - Scratches
 - Dirt
-

Tightening torques inspection

- Safety Locks:
front and rear suspension unit
front and rear brake calliper retainer unit
front and rear wheel unit
engine - chassis retainers
steering assembly
 - Plastic parts fixing screws
-

Electrical system

- Main switch
 - Lights: high-beam lights, low-beam lights, tail lights (front and rear) and their warning lights
 - Headlight adjustment according to regulations in force
 - Front and rear stop light buttons and their bulbs
 - Turn indicators and the respective warning lights
 - Instrument panel lighting
 - Instrument panel: fuel and temperature indicator (if present)
 - Instrument panel warning lights
 - Horn
 - Electric start-up
 - Engine stop via emergency stop switch and side stand
 - Electric saddle opening button (if present)
-

- Through the diagnosis instrument, check that the last mapping version is present in the control unit/s and reprogram the control unit/s, if required: consult the technical service website to know if there are available upgrades and for details on the operations.

CAUTION

TO ENSURE MAXIMUM PERFORMANCE, THE BATTERY MUST BE CHARGED BEFORE USE. INADEQUATE CHARGING OF THE BATTERY WITH A LOW LEVEL OF ELECTROLYTE BEFORE IT IS FIRST USED SHORTENS THE LIFE OF THE BATTERY.

CAUTION

UPON INSTALLING THE BATTERY, ATTACH THE POSITIVE LEAD FIRST AND AFTERWARDS THE NEGATIVE LEAD.

WARNING

THE BATTERY ELECTROLYTE IS POISONOUS AS IT MAY CAUSE SERIOUS BURNS. IT CONTAINS SULPHURIC ACID. AVOID CONTACT WITH THE EYES, THE SKIN AND CLOTHING. IF COMING INTO CONTACT WITH EYES OR SKIN, WASH ABUNDANTLY WITH WATER FOR APPROX. 15 MIN. AND SEEK IMMEDIATE MEDICAL ATTENTION. IF ACCIDENTALLY SWALLOWED, IMMEDIATELY DRINK LARGE QUANTITIES OF WATER OR VEGETABLE OIL. SEEK IMMEDIATE MEDICAL ATTENTION. THE BATTERIES PRODUCE EXPLOSIVE GAS; KEEP AWAY FROM NAKED FLAMES, SPARKS OR CIGARETTES. VENTILATE THE AREA WHEN RECHARGING INDOORS. ALWAYS WEAR EYE PROTECTION WHEN WORKING IN THE PROXIMITY OF BATTERIES. KEEP OUT OF THE REACH OF CHILDREN

CAUTION

NEVER USE FUSES WITH A CAPACITY HIGHER THAN THE RECOMMENDED CAPACITY. USING A FUSE OF UNSUITABLE RATING MAY SERIOUSLY DAMAGE THE VEHICLE OR EVEN CAUSE A FIRE.

Levels check

- Hydraulic braking system fluid level
- Rear hub oil level
- Engine coolant level (if present)
- Engine oil level
- Mixer oil level (if present)

Road test

- Cold start
- Instrument panel operation
- Response to the throttle control
- Stability when accelerating and braking

- Front and rear brake efficiency
 - Front and rear suspension efficiency
 - Abnormal noise
-

Static test

Static check after test drive:

- Restarting when warmed up
 - Starter operation (if present)
 - Idle speed (turning the handlebar))
 - Uniform turning of the steering
 - Possible leaks
 - Radiator electric fan operation (if present)
-

Functional inspection

- Hydraulic braking system
- Stroke of the brake levers
- Clutch - Check for correct operation
- Engine - Check for correct general operation and absence of abnormal noise
- Other
- Document check:
 - Check for chassis and engine numbers
 - Check for toolkit
 - License plate fitting
 - Lock check
 - Tyre pressure check
 - Installation of mirrors and accessories



NEVER EXCEED THE RECOMMENDED INFLATION PRESSURES AS THE TYRES MAY BURST.
CAUTION



CHECK AND ADJUST TYRE PRESSURE WITH TYRES AT AMBIENT TEMPERATURE.
